

External Drive Piezo Transducer (AC)

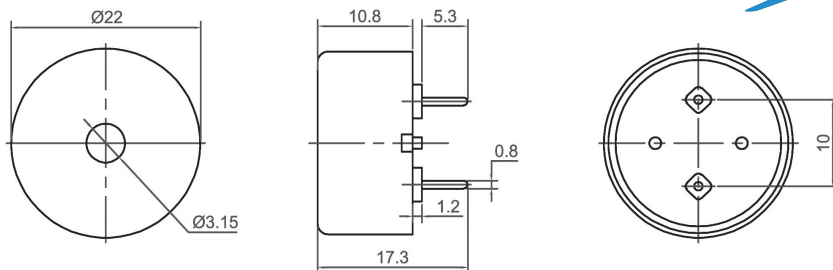

CPT2211

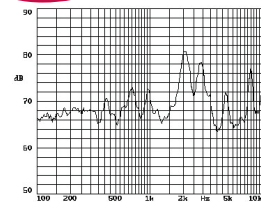

Canopus Part no.	Min sound Output (dBA)	Rated Voltage (V)	Max Input Voltage (V)	Resonant Frequency (Hz)	Capacitance (pF)	Operating Temperature (°C)	Housing	Weight (g)
CPT2211C20TP	70 AT 10cm	3 Vp-p	30 Vrms	2000	30000 ± 30% at 1000Hz	-30 ~ +70	PBT	3.2
CPT2211C40TP	85 AT 10cm	3 Vp-p	40 Vrms	4000	15000 ± 30% at 1000Hz	-30 ~ +70	PBT	3.2

CANOPUS



CPT2305

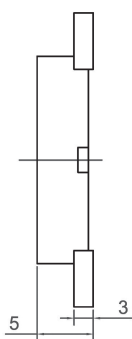
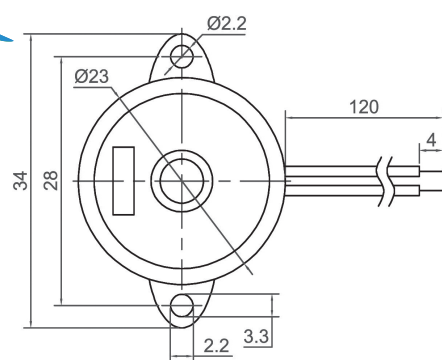
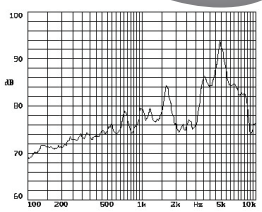

Canopus Part no.	Min sound Output (dBA)	Rated Voltage (V)	Max Input Voltage (V)	Resonant Frequency (Hz)	Capacitance (pF)	Operating Temperature (°C)	Housing	Weight (g)
CPT2305I40BW	80 AT 10cm	12 Vp-p	40 Vrms	4000	23000 ± 30% at 1000Hz	-20 ~ +60	ABS	2

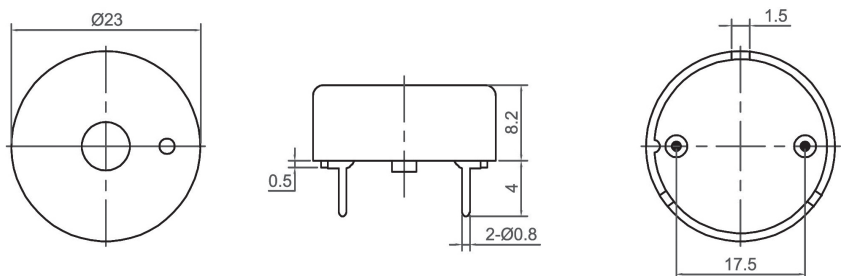

CPT2308

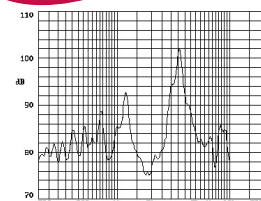

Canopus Part no.	Min sound Output (dBA)	Rated Voltage (V)	Max Input Voltage (V)	Resonant Frequency (Hz)	Capacitance (pF)	Operating Temperature (°C)	Housing	Weight (g)
CPT2308G30NP	80 AT 10cm	9 Vp-p	40 Vrms	3000	24000 ± 30% at 1000Hz	-30 ~ +80	Noryl	2

Your Efficient Supplier
www.canopus.com.hk

TEL.: (852) 2806 2812 Fax: (852) 2652 2216