

External Drive Piezo Transducer (AC)

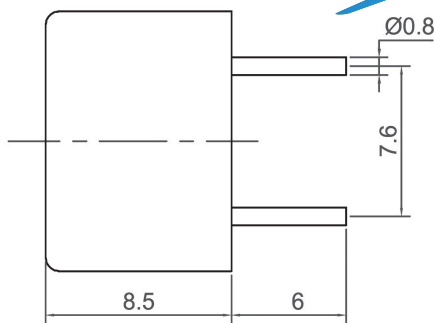

CPT1208

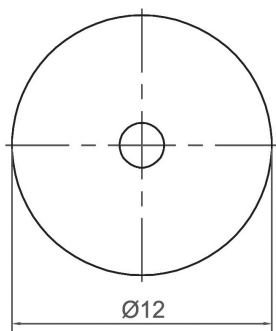
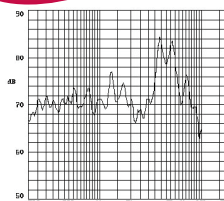

| Canopus Part no. | Min sound Output (dBA) | Rated Voltage (V) | Max Input Voltage (V) | Resonant Frequency (Hz) | Capacitance (pF) | Operating Temperature (°C) | Housing | Weight (g) |
|------------------|------------------------|-------------------|-----------------------|-------------------------|-----------------------|----------------------------|---------|------------|
| CPT1208C40TP | 70 AT 10cm | 3 Vp-p | 30 Vrms | 4000 | 14000 ± 30% at 1000Hz | -20 ~ +70 | PBT | 2 |

CANOPUS



CPT1302

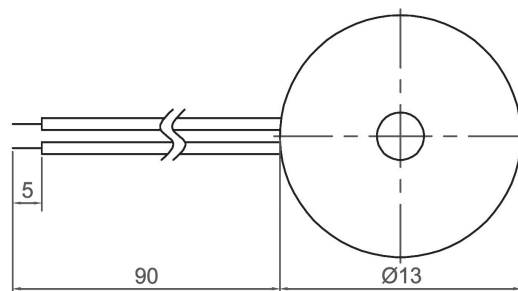
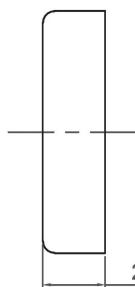
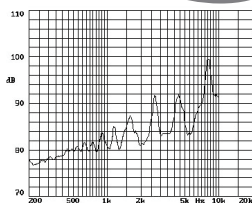

| Canopus Part no. | Min sound Output (dBA) | Rated Voltage (V) | Max Input Voltage (V) | Resonant Frequency (Hz) | Capacitance (pF) | Operating Temperature (°C) | Housing | Weight (g) |
|------------------|------------------------|-------------------|-----------------------|-------------------------|-----------------------|----------------------------|---------|------------|
| CPT1302H48BW | 80 AT 10cm | 10 Vp-p | 30 Vrms | 4800 | 15000 ± 30% at 1000Hz | -20 ~ +70 | ABS | 1 |

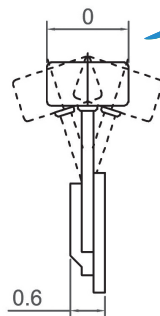
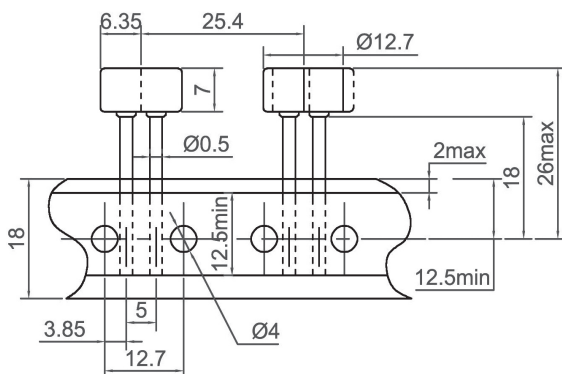

CPT1306C

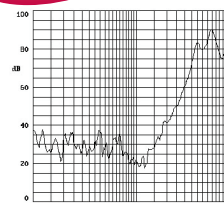

| Canopus Part no. | Min sound Output (dBA) | Rated Voltage (V) | Max Input Voltage (V) | Resonant Frequency (Hz) | Capacitance (pF) | Operating Temperature (°C) | Housing | Weight (g) |
|------------------|------------------------|-------------------|-----------------------|-------------------------|-----------------------|----------------------------|---------|------------|
| CPT1306C40TP | 75 AT 10cm | 3 Vp-p | 30 Vrms | 4000 | 12000 ± 30% at 1000Hz | -20 ~ +70 | PBT | 0.65 |

Your Efficient Supplier
www.canopus.com.hk

TEL.: (852) 2806 2812

Fax: (852) 2652 2216