



## GLASS PASSIVATED SINGLE-OHASE BPIDGE RECTIFIER

**GBPC15005/W THRU GBPC1510/W**

**VOLTAGE RANGE**

**50 to 1000 Volts**

**CURRENT**

**15.0 Ampere**

### FEATURES

- Plastic package has UL flammability classification 94V-0
- Integrally molded heatsink provides very low thermal resistance for maximum heat dissipation
- High forward surge capacity
- Glass passivated chip junction
- High isolation voltage from case to lugs
- High temperature soldering guaranteed: 260°C/10 seconds,
- Available in either lug package (GBPC5005) or wire lead package (GBPC15005W)

### MECHANICAL DATA

- Case: Epoxy, Molded Plastic with integrally mounted heatsink
- Terminals: Plated 0.25" (6.35mm) lug or plated 0.040" (1.02mm) diameter lead
- Polarity: Polarity symbols marked on case
- Mounting: Thru hole for #10 screw, 20 in-lbs Torque max. See Note 3
- Weight: 0.53 ounce, 15.0 gram-GBPC15 and GBPC15-W

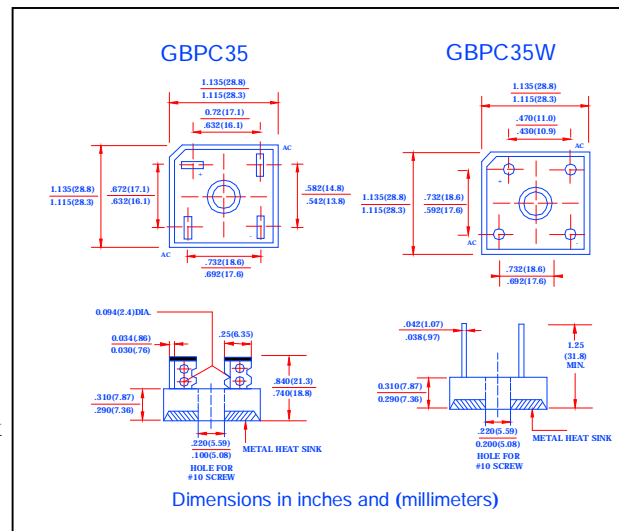

### MAXIMUM RATINGS AND ELECTRICAL CHARACTERISTICS

- Ratings at 25°C ambient temperature unless otherwise specified
- Single Phase, half wave, 60Hz, resistive or inductive load
- For capacitive load derate current by 20%

	SYMBOLS	GBPC 15005/W	GBPC 1501/W	GBPC 1502/W	GBPC 1504/W	GBPC 1506/W	GBPC 1508/W	GBPC 1510/W	UNIT
Maximum Repetitive Peak Reverse Voltage	$V_{RRM}$	50	100	200	400	600	800	1000	Volts
Maximum RMS Voltage	$V_{RMS}$	35	70	140	280	420	560	700	Volts
Maximum DC Blocking Voltage	$V_{DC}$	50	100	200	400	600	800	1000	Volts
Maximum Average Forward Rectified Current (SEE FIG.1) at $T_C=55^\circ C$	$I_{(AV)}$	15							Amps
Peak Forward Surge Current 8.3mS single half sine wave superimposed on rated load (JEDEC method)	$I_{FSM}$	300							Amps
Rating for Fusing ( $t < 8.3ms$ )	$I^2t$	375							$A^2s$
Maximum Instantaneous Forward Voltage drop Per Bridge element 7.5A	$V_F$	1.1							Volts
Maximum DC Reverse Current at rated DC blocking Voltage per element	$T_A = 25^\circ C$	5.0							$\mu A$
	$T_A = 125^\circ C$	500							
Isolation Voltage from case to lug or lead	$V_{ISO}$	2500							nS
Typical Junction Capacitance per leg (NOTE 1)	$C_j$	300							pF
Typical Thermal Resistance per leg (NOTE 2)	$R_{\theta JC}$	1.9							$^\circ C/W$
Operating Junction Temperature	$T_J$	(-55 to +150)							$^\circ C$
Storage Temperature Range	$T_{STG}$	(-55 to +150)							$^\circ C$

#### Notes:

1. Measured at 1.0MHz and applied reverse voltage of 4.0V
2. Thermal resistance from junction to case per leg
3. Bolt down on heat-sink with silicon thermal compound between bridge and mounting surface for maximum heat transfer efficiency with #10 screw.



# GLASS PASSIVATED SINGLE-OHASE BPIDGE RECTIFIER

GBPC15005/W THRU GBPC1510/W

VOLTAGE RANGE 50 to 1000 Volts  
CURRENT 15.0 Ampere

## RATINGS AND CHARACTERISTICS CURVES GBPC15005/W THRU GBPC1510/W

FIG. 1 - MAXIMUM OUTPUT RECTIFIED CURRENT

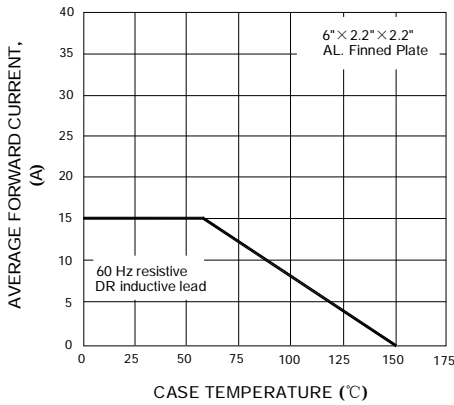

FIG. 2 - MAXIMUM OUTPUT RECTIFIED CURRENT

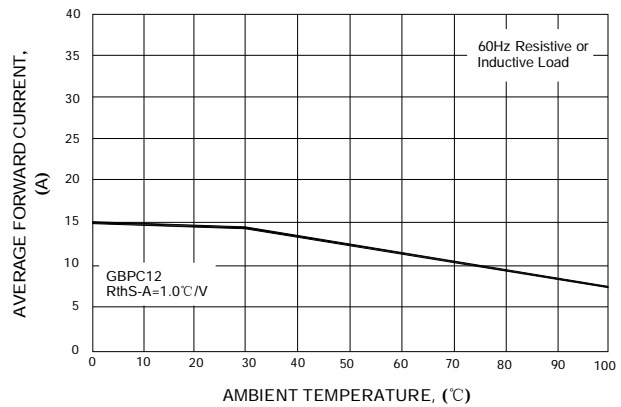

FIG. 3 - MAXIMUM POWER DISSIPATION

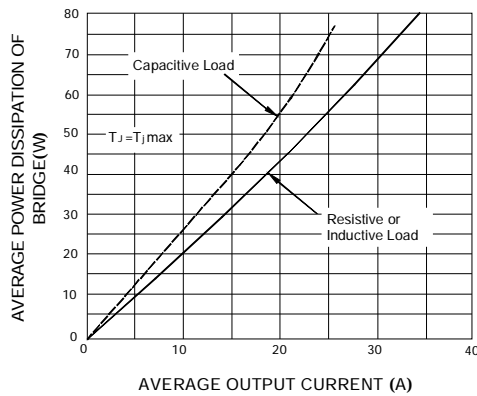
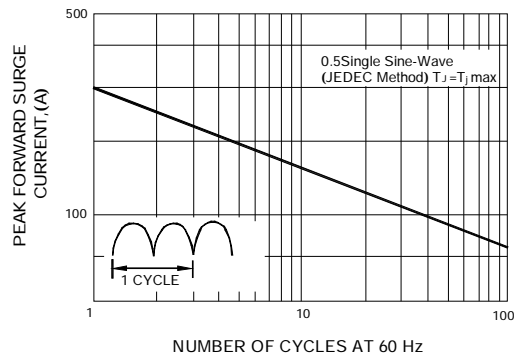

FIG. 4 - MAXIMUM NON-REPETITIVE PEAK FORWARD SURGE CURRENT PER LEG





# GLASS PASSIVATED SINGLE-OHASE BPIDGE RECTIFIER

GBPC15005/W THRU GBPC1510/W

VOLTAGE RANGE 50 to 1000 Volts  
CURRENT 15.0 Ampere

## RATINGS AND CHARACTERISTIC CURVES GBPC15005/W THRU GBPC1510/W

FIG. 5- TYPICAL INSTANTANEOUS FORWARD CHARACTERISTICS PER LEG

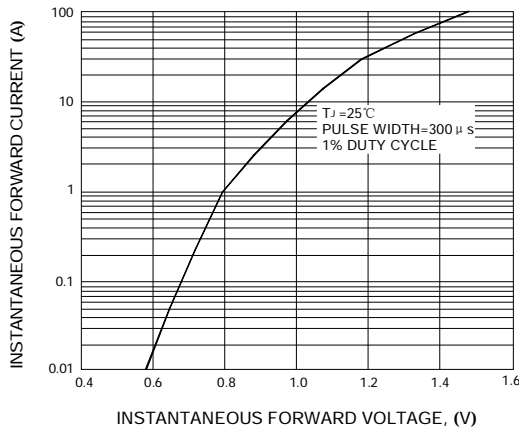

FIG. 6 - TYPICAL REVERSE LEAKAGE CHARACTERISTICS PER LEG

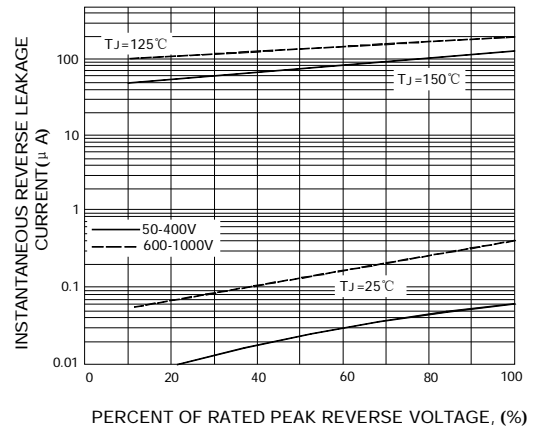

FIG. 7 - TYPICAL JUNCTION CAPACITANCE PER LEG

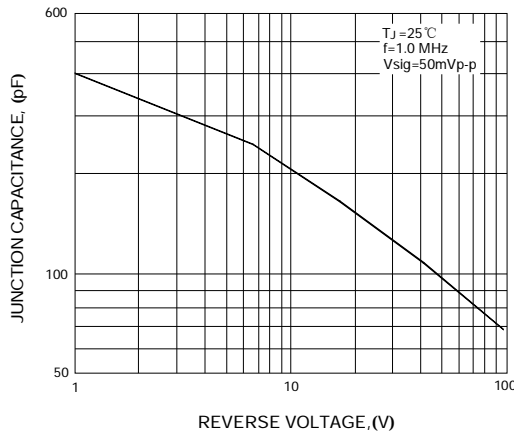

FIG. 8 - TYPICAL TRANSIENT THERMAL IMPEDANCE PER LEG

