

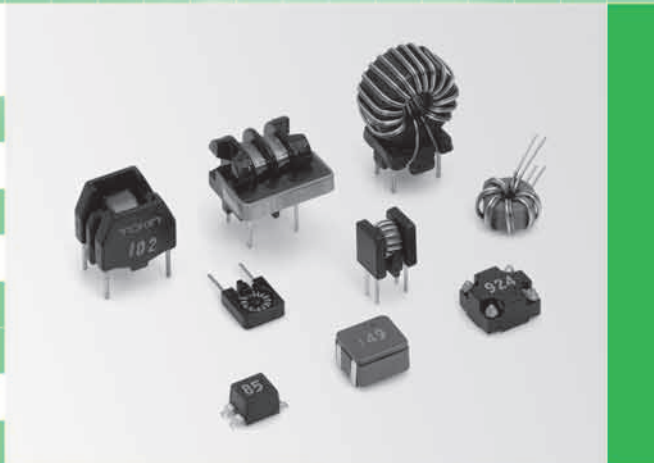

# DC Line Filters

# DC Filters



- All specifications in this catalog and production status of products are subject to change without notice. Prior to the purchase, please contact NEC TOKIN for updated product data.
- Please request for a specification sheet for detailed product data prior to the purchase.
- Before using the product in this catalog, please read "Precautions" and other safety precautions listed in the printed version catalog.

# Contents

Classification of NEC TOKIN's EMI suppression parts .....	3
<b>DIP Type</b>	
Common Mode Power Line	
SH Series .....	8
SHO Series .....	10
SBT-03W Series .....	11
Common Mode Signal Line	
SBT-01W Series .....	12
Toroidal Cores with Wound Cables .....	13
DIP Noise Filters D-03C, 03C1, 05N1, 07C1, 08C2, 08C2A ..	14
DIP Noise Filters D-16C .....	16
DIP Noise Filters D-37C, 40C, 42C, 45C, 47C .....	17
DIP Noise Filters D-55C, 58C .....	19
Common Mode for Telephone Sets	
Noise Filters for Telephone Sets ST-101, 201, 202, 202S ..	20
Noise Filters for Telephone Sets ST-101A, 201A, 202A ..	21
Noise Filters for Telephone Sets ST-110AV, 110AH, 110BV, 110BH ..	22
Noise Filters for Telephone Sets ST-101F2, 101F4 .....	23
Noise Filters for Telephone Sets ST-104A4, 204A Series ..	24
Normal Mode	
SBT Series .....	25
SNT Series .....	26
Bead Inductors (Lead Type) .....	27
Bead Inductors(Winding Type) .....	30
EMC Filter	
DFD Series .....	32
Tape and Reel Dimensions .....	33
<b>SMD Type</b>	
Common Mode Power Line	
SBS9080 Series .....	34
SBP Series .....	35
DCM Series .....	36
Common Mode Signal Line	
EMC Chip Filters M-500CT/M-600T Series .....	38
Precautions .....	40
Tape and Reel Dimensions .....	41



- All specifications in this catalog and production status of products are subject to change without notice. Prior to the purchase, please contact NEC TOKIN for updated product data.
- Please request for a specification sheet for detailed product data prior to the purchase.
- Before using the product in this catalog, please read "Precautions" and other safety precautions listed in the printed version catalog.

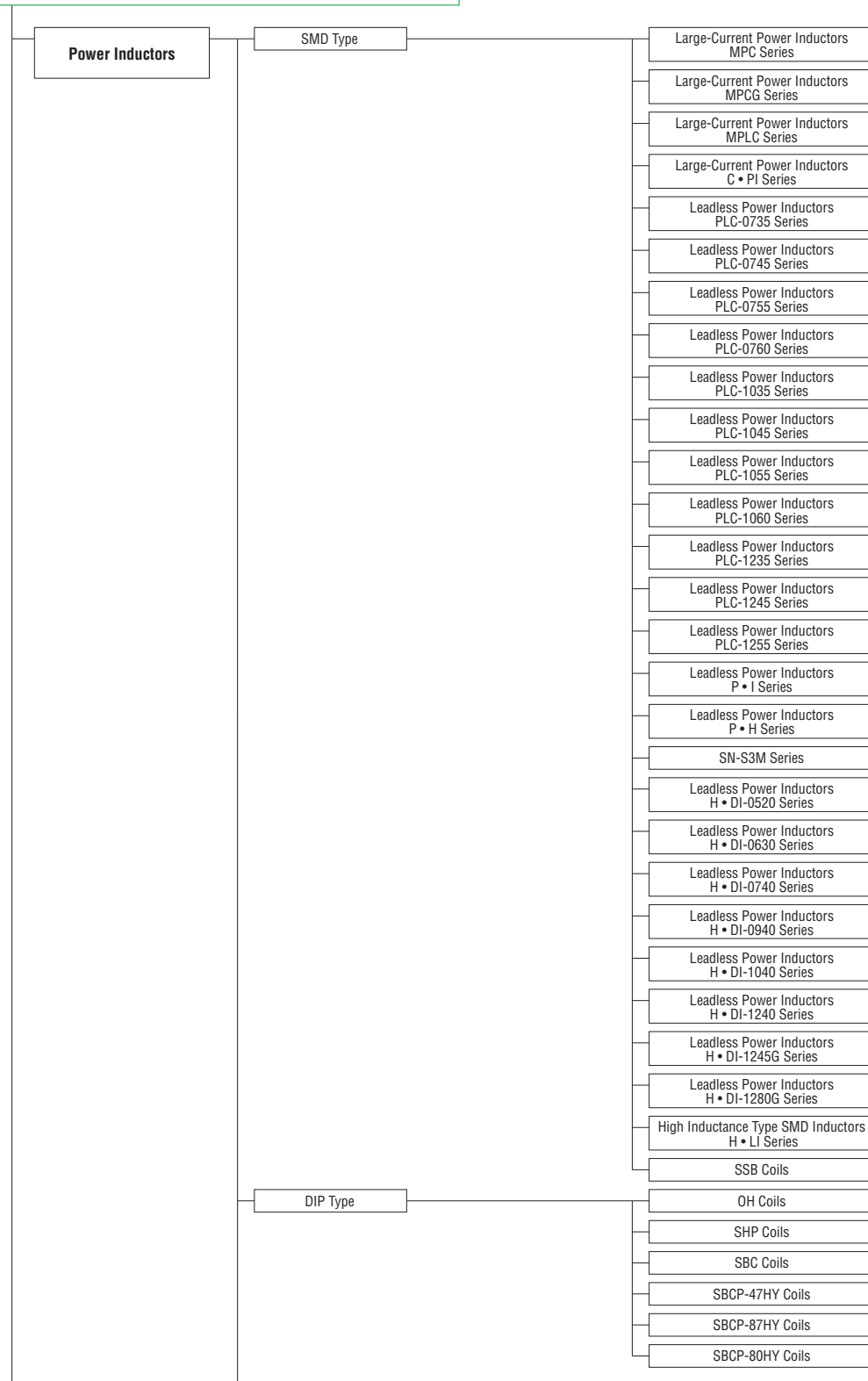

(Continued)



- All specifications in this catalog and production status of products are subject to change without notice. Prior to the purchase, please contact NEC TOKIN for updated product data.
- Please request for a specification sheet for detailed product data prior to the purchase.
- Before using the product in this catalog, please read "Precautions" and other safety precautions listed in the printed version catalog.

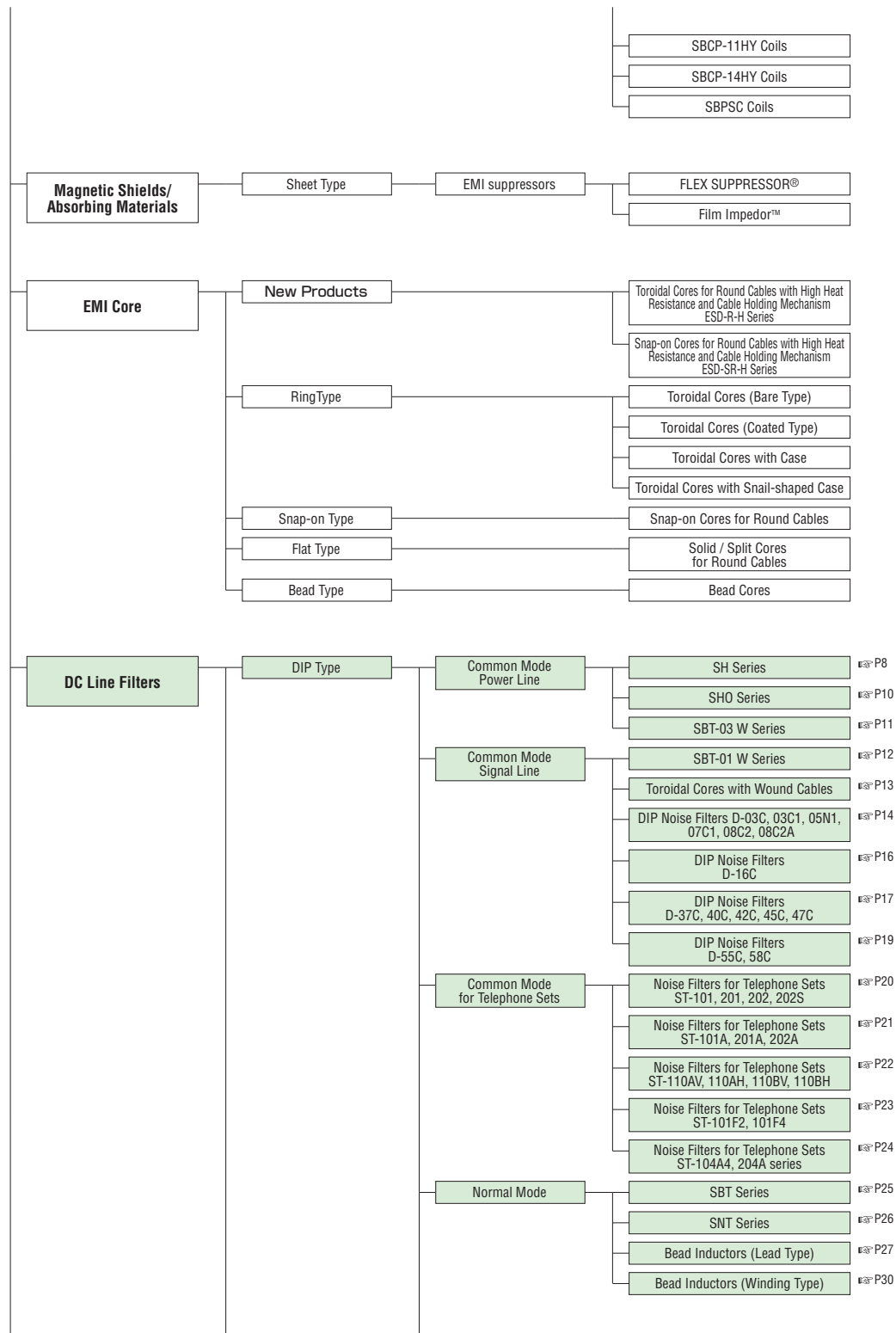

(Continued)



- All specifications in this catalog and production status of products are subject to change without notice. Prior to the purchase, please contact NEC TOKIN for updated product data.
- Please request for a specification sheet for detailed product data prior to the purchase.
- Before using the product in this catalog, please read "Precautions" and other safety precautions listed in the printed version catalog.

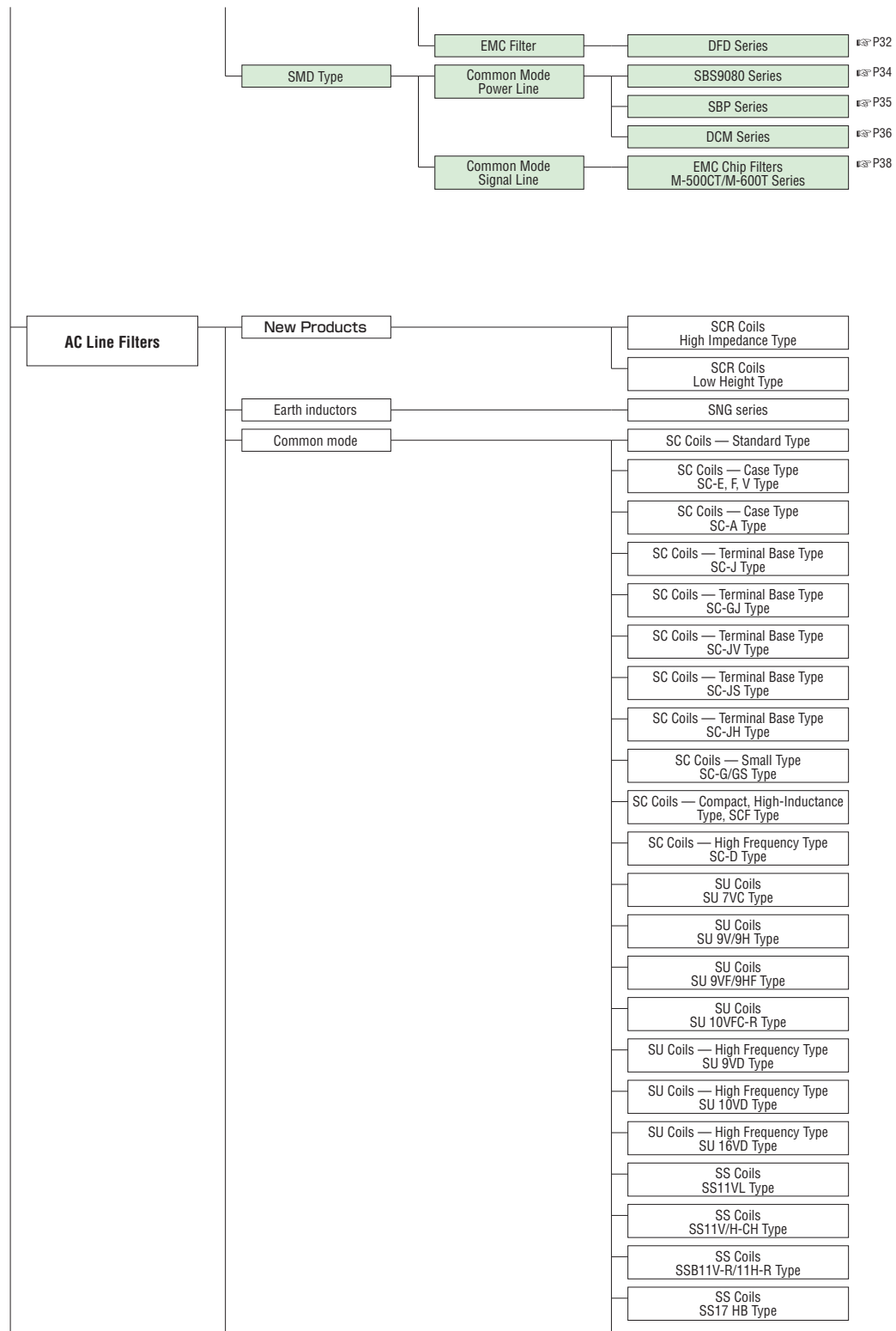

(Continued)



- All specifications in this catalog and production status of products are subject to change without notice. Prior to the purchase, please contact NEC TOKIN for updated product data.
- Please request for a specification sheet for detailed product data prior to the purchase.
- Before using the product in this catalog, please read "Precautions" and other safety precautions listed in the printed version catalog.

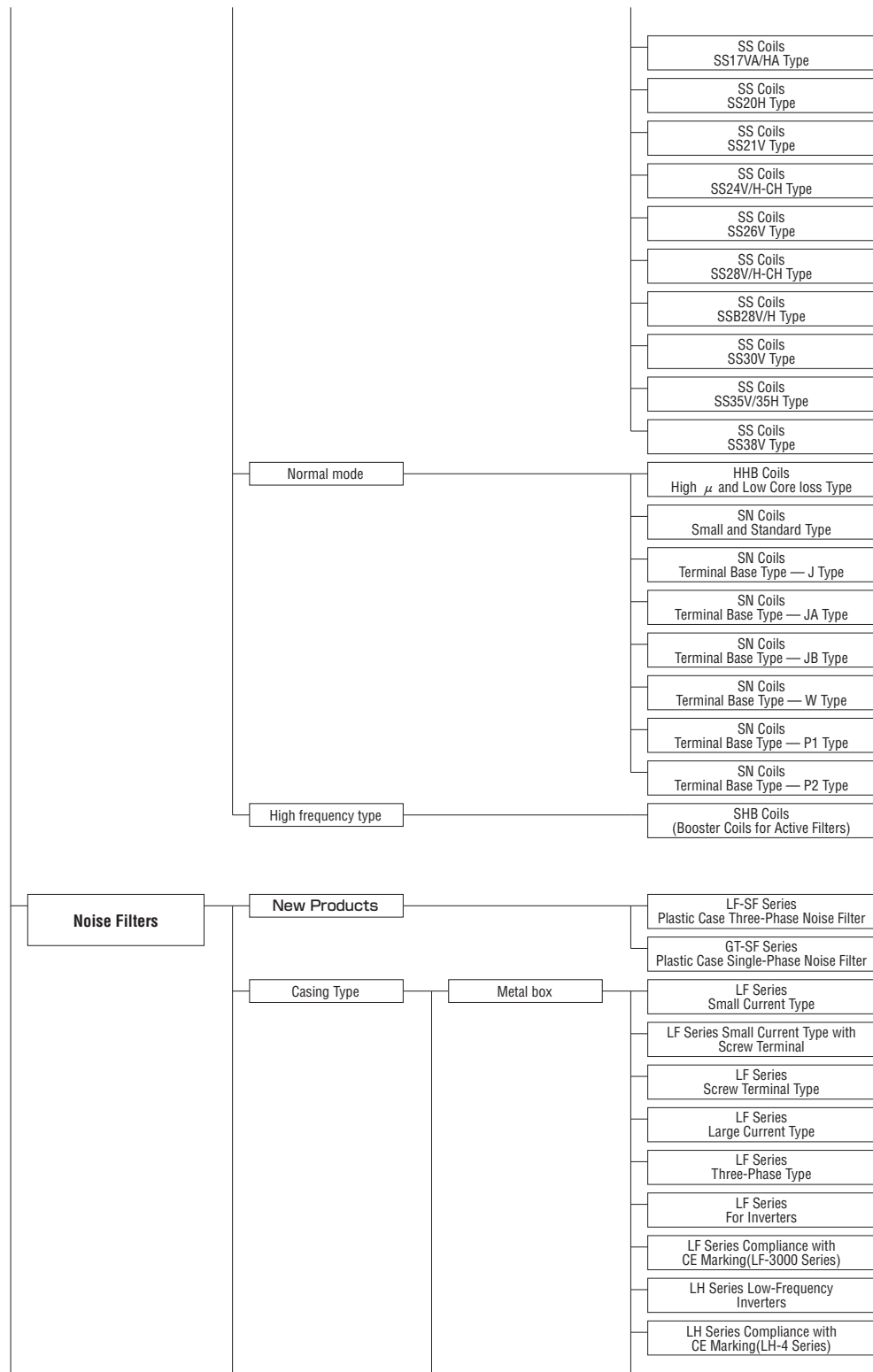

(Continued)



- All specifications in this catalog and production status of products are subject to change without notice. Prior to the purchase, please contact NEC TOKIN for updated product data.
- Please request for a specification sheet for detailed product data prior to the purchase.
- Before using the product in this catalog, please read "Precautions" and other safety precautions listed in the printed version catalog.

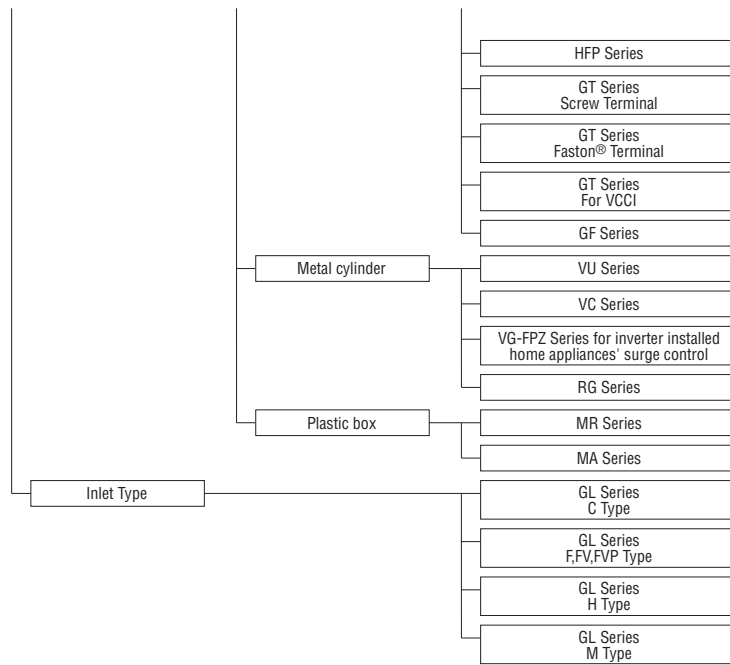

- All specifications in this catalog and production status of products are subject to change without notice. Prior to the purchase, please contact NEC TOKIN for updated product data.
- Please request for a specification sheet for detailed product data prior to the purchase.
- Before using the product in this catalog, please read "Precautions" and other safety precautions listed in the printed version catalog.

# SH Series

[RoHS Compliant]

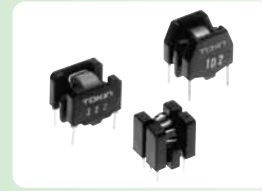

Model	Rated voltage DC (V)	Rated current (A)	Inductance (μH) min.	DC resistance (mΩ/line) max.	Operating temperature range (°C)	Shape and dimensions	
<b>SH-101</b>	150	3.0	0.35	16	-25 to +80	Fig. 1	
<b>SH-102</b>	150	3.0	1.5	26	-25 to +80		
<b>SH-201</b>	150	3.0	0.5	16	-25 to +80		
<b>SH-202</b>	150	3.0	1.5	20	-25 to +80		
<b>SH-301</b>	150	3.0	3.2	22	-25 to +80		
<b>SH-302</b>	150	3.0	7.5	26	-25 to +80		
for 2 lines	<b>SH-211</b>	150	3.0	0.5	18	-25 to +80	Fig. 2
	<b>SH-212</b>	150	3.0	1.5	23	-25 to +80	
	<b>SH-311</b>	150	3.0	3.2	25	-25 to +80	
	<b>SH-312</b>	150	3.0	7.5	30	-25 to +80	Fig. 3
	<b>SH-121</b>	50	3.0	0.35	11	-25 to +80	
	<b>SH-122</b>	50	3.0	1.5	20	-25 to +80	
<b>SH-321</b>	50	3.0	3.5	14	-25 to +80		
for 3 lines	<b>SH-322</b>	50	3.0	7.5	20	-25 to +80	Fig. 4
	<b>SH-132</b>	50	2.4	2.6	51	-25 to +60	
	<b>SH-432</b>	50	2.4	30.0	51	-25 to +60	Fig. 5



- All specifications in this catalog and production status of products are subject to change without notice. Prior to the purchase, please contact NEC TOKIN for updated product data.
- Please request for a specification sheet for detailed product data prior to the purchase.
- Before using the product in this catalog, please read "Precautions" and other safety precautions listed in the printed version catalog.



Shape and Dimensions/Circuit Diagram

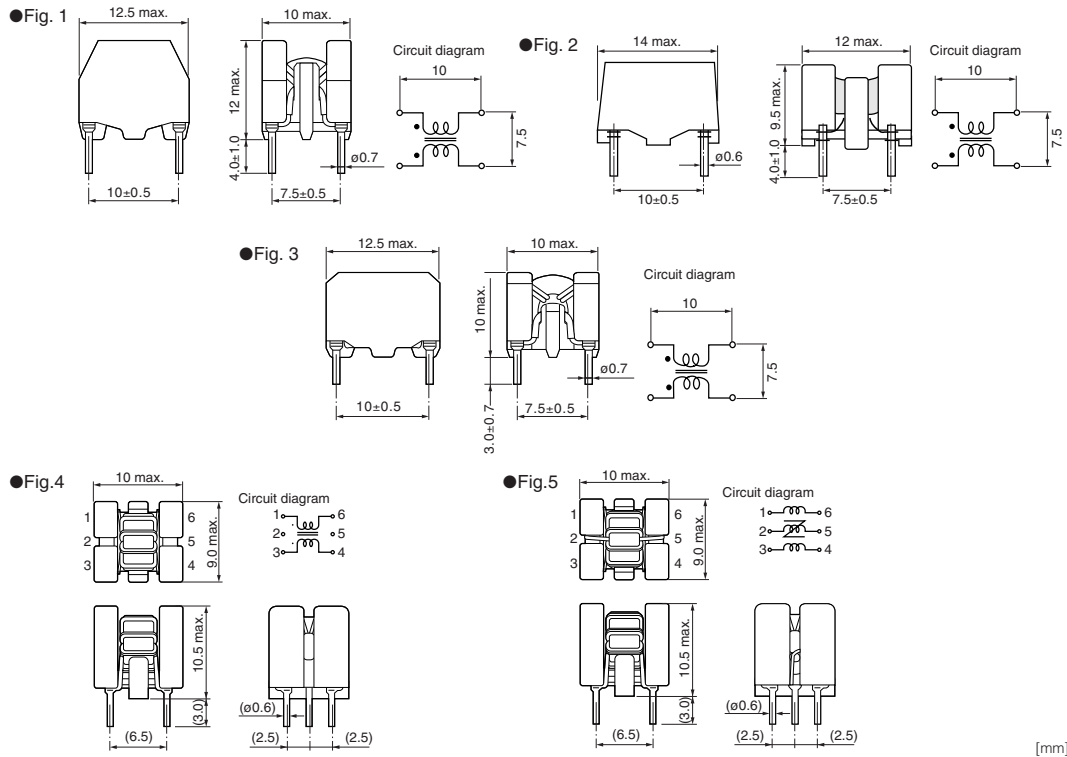

[mm]

Impedance vs. Frequency

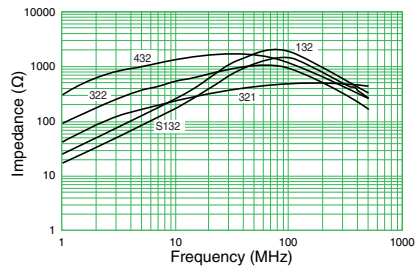
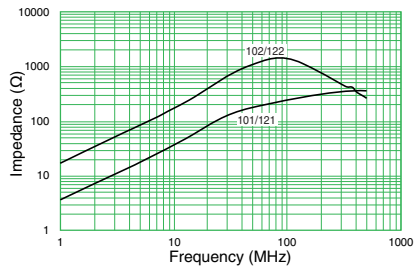
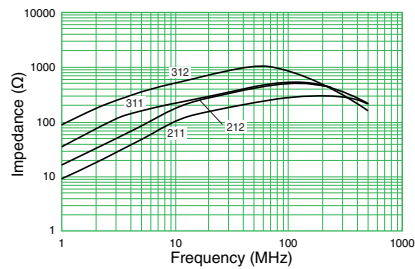
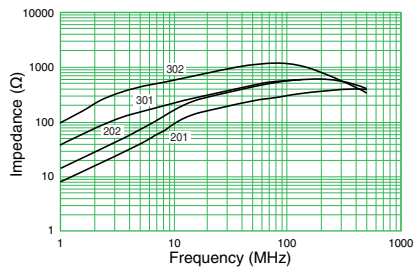

- All specifications in this catalog and production status of products are subject to change without notice. Prior to the purchase, please contact NEC TOKIN for updated product data.
- Please request for a specification sheet for detailed product data prior to the purchase.
- Before using the product in this catalog, please read "Precautions" and other safety precautions listed in the printed version catalog.

# SHO Series

[RoHS Compliant]



Model	Rated voltage DC (V)	Rated current (A)	Inductance (μH) min.	DC resistance (mΩ/line) max.	Operating temperature range (°C)	Dimensions(mm)		
						D	T	ℓ
SHO-101	50	4.0	2.0	15.5	-25 to +70	11Max.	7.5Max.	10±3
SHO-102	50	4.0	0.6	10.0	-25 to +70	11Max.	7.5Max.	10±3
SHO-301	50	4.0	12.0	15.5	-25 to +70	11Max.	7.5Max.	10±3
SHO-302	50	4.0	3.9	10.0	-25 to +70	11Max.	7.5Max.	10±3
SHO-303	50	5.0	6.0	8.0	-25 to +75	11Max.	8Max.	10±3
SHO-402	50	0.8	99.0	120.0	-25 to +80	7.5Max.	5Max.	4±2
SHO-501	50	0.8	17.5	105.0	-25 to +80	6.2Max.	3.4Max.	4±2

### Shape and Dimensions

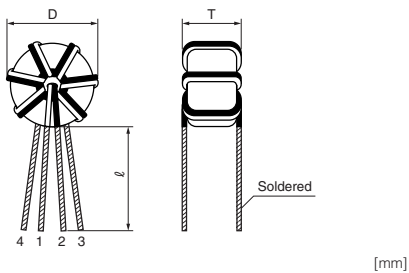

### Circuit Diagram

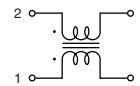

### Impedance vs. Frequency

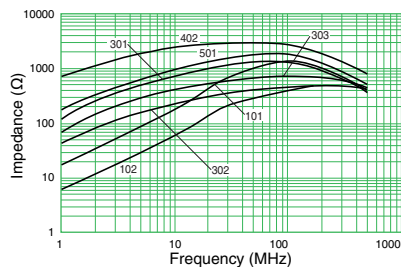

- All specifications in this catalog and production status of products are subject to change without notice. Prior to the purchase, please contact NEC TOKIN for updated product data.
- Please request for a specification sheet for detailed product data prior to the purchase.
- Before using the product in this catalog, please read "Precautions" and other safety precautions listed in the printed version catalog.

# SBT-03W Series

[RoHS Compliant]



Model	Rated voltage DC (V)	Rated current (A)	Inductance (100kHz, 1mA) (μH) min.	DC resistance (mΩ) max.	Operating temperature range (°C)	Wire size (mmφ)	Packaging
<b>SBT-0308W</b>	50	3.0	6.75	20	-25 to +85	0.4	Bulk (100 pcs.)
<b>SBT-0310W</b>	50	2.5	7.7	30	-25 to +80	0.35	
<b>SBT-0315W</b>	50	2.0	11.9	45	-25 to +75	0.3	

- Withstanding voltage: 200VDC (one minute, between lines)
- Insulation resistance: more than 10MΩ (100VDC, between lines)

## Shape and Dimensions

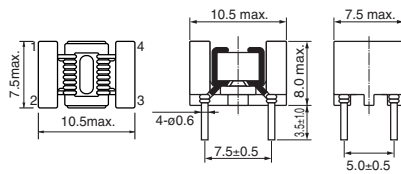

[mm]

## Circuit Diagram

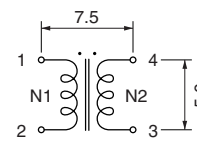

[mm]

## Impedance vs. Frequency

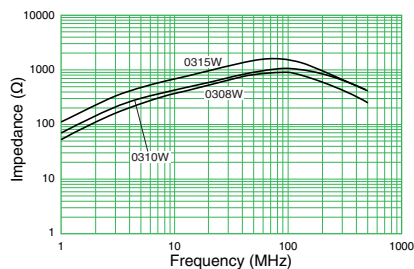

- All specifications in this catalog and production status of products are subject to change without notice. Prior to the purchase, please contact NEC TOKIN for updated product data.
- Please request for a specification sheet for detailed product data prior to the purchase.
- Before using the product in this catalog, please read "Precautions" and other safety precautions listed in the printed version catalog.

# SBT-01W Series

[RoHS Compliant]



Model	Rated voltage DC (V)	Rated current (mA)	Inductance (1kHz, 70mA) (μH)	DC resistance (mΩ) max.	Operating temperature range (°C)	Packaging
<b>SBT-0115W</b>	50	500	≥5	30	-25 to +70	Bulk (100pcs.)
<b>SBT-0140W</b>	50	500	40±35%	40	-25 to +70	
<b>SBT-0160W</b>	50	500	60±35%	45	-25 to +70	
<b>SBT-0180W</b>	50	500	80±35%	55	-25 to +70	

• Withstanding voltage: 200VDC (one minute, between lines) • Insulation resistance: more than 10MΩ (100VDC, between lines)

## Shape and Dimensions

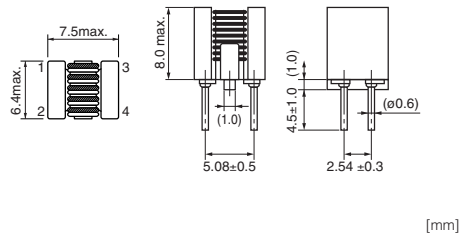

## Circuit Diagram

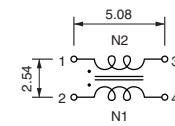

## Impedance vs. Frequency

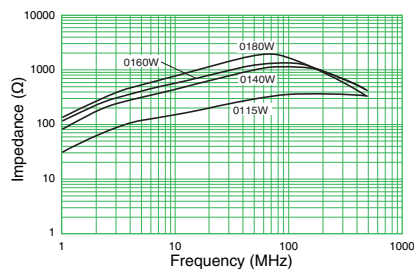

- All specifications in this catalog and production status of products are subject to change without notice. Prior to the purchase, please contact NEC TOKIN for updated product data.
- Please request for a specification sheet for detailed product data prior to the purchase.
- Before using the product in this catalog, please read "Precautions" and other safety precautions listed in the printed version catalog.

# Toroidal Cores with Wound Cables

[RoHS Compliant]



Model	Core	Dimensions (mm)				No. of turns	Wire	Winding status	Frequency range (MHz)
		A	B	C	D				
ESD-H-12E	ESD-R-12C	16	20	5	25	7	UL1007 AWG26 (ø0.4)	Bi-filar winding	Up to 300
ESD-H-14U	ESD-R-14A	17.5	7	5	15	10	UL1609 AWG26 (ø0.4)	Bi-filar winding	Up to 100
ESD-H-14NU	ESD-R-14C2	17.5	7	5	15	10	UL1609 AWG26 (ø0.4)	Bi-filar winding	Up to 300

• Recommended soldering conditions: 350±10°C, 2 to 3 sec. • Rated current:1A • Rated Voltage: 125V

## Shape and Dimensions

●ESD-H Series

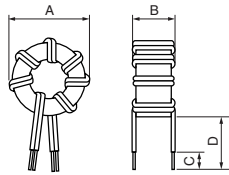

## Circuit Diagram



## Impedance vs. Frequency

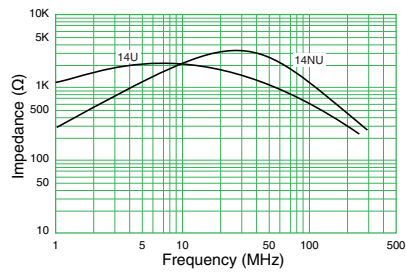
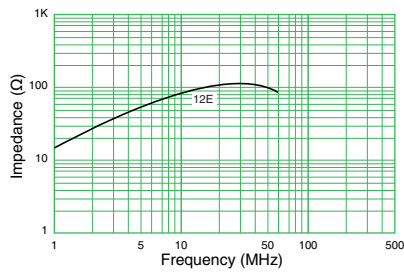

- All specifications in this catalog and production status of products are subject to change without notice. Prior to the purchase, please contact NEC TOKIN for updated product data.
- Please request for a specification sheet for detailed product data prior to the purchase.
- Before using the product in this catalog, please read "Precautions" and other safety precautions listed in the printed version catalog.

# DIP Noise Filters

## D-03C, 03C1, 05N1, 07C1, 08C2, 08C2A

[RoHS Compliant]



Model	Circuit diagram	Number of terminals/Circuits	Rated voltage DC (V)	Rated current DC (mA/Line)	DC resistance (mΩ/Line) max.	Operating temperature range (°C)
<b>D-03C</b>		4 cores	50	150	75	-20 to +70
<b>D-03C1</b>				100	150	-20 to +70
<b>D-05N1</b>		8 cores	50	100	10	-20 to +70
<b>D-07C1</b>		1 core	50	300	100	-20 to +70
<b>D-08C2</b>		1 core	50	2300	25	-20 to +70
<b>D-08C2A</b>		1 core	50	500	70	-25 to +65

• Withstanding voltage: 200VDC (one minute, between lines) • Insulation resistance: more than 10MΩ (100VDC, between lines)

### Shape and Dimensions

●D-03C, 03C1

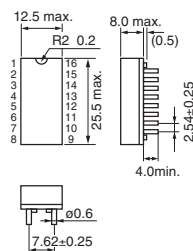

●D-05N1

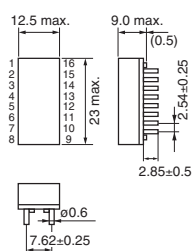

●D-07C1

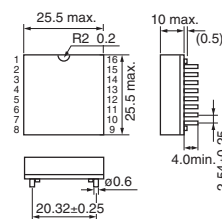

●D-08C2

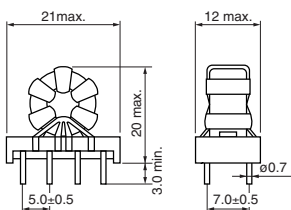

●D-08C2A

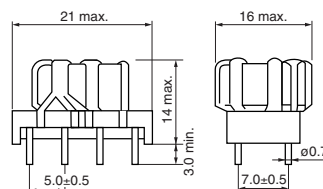

[mm]



- All specifications in this catalog and production status of products are subject to change without notice. Prior to the purchase, please contact NEC TOKIN for updated product data.
- Please request for a specification sheet for detailed product data prior to the purchase.
- Before using the product in this catalog, please read "Precautions" and other safety precautions listed in the printed version catalog.

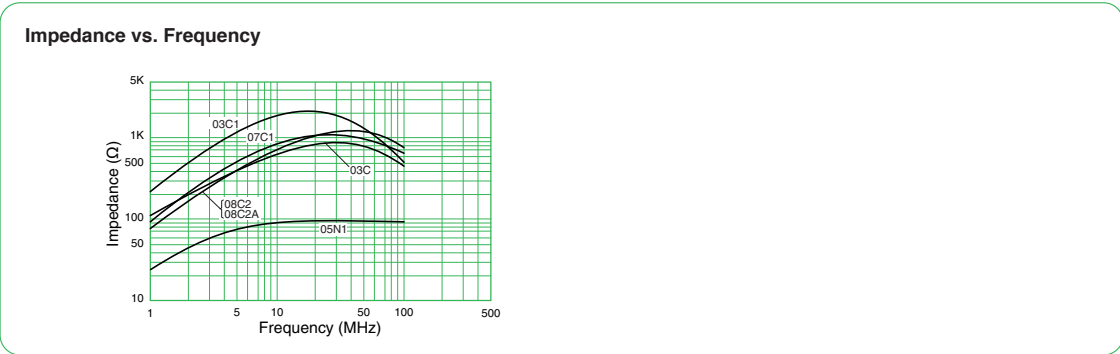

- All specifications in this catalog and production status of products are subject to change without notice. Prior to the purchase, please contact NEC TOKIN for updated product data.
- Please request for a specification sheet for detailed product data prior to the purchase.
- Before using the product in this catalog, please read "Precautions" and other safety precautions listed in the printed version catalog.

# DIP Noise Filters

## D-16C

[RoHS Compliant]



Model	Circuit diagram	Number of terminals/ Circuits	Rated voltage DC (V)	Rated current DC (mA/Line)	DC resistance (mΩ/Line) max.	Operating temperature range (°C)
D-16C		1 core 8P/4 circuits Common mode	50	100	50	-20 to +70

- Withstanding voltage: 200VDC (one minute, between lines)
- Insulation resistance: more than 10MΩ (100VDC, between lines)

### Shape and Dimensions

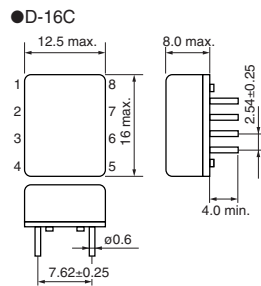

[mm]

### Impedance vs. Frequency

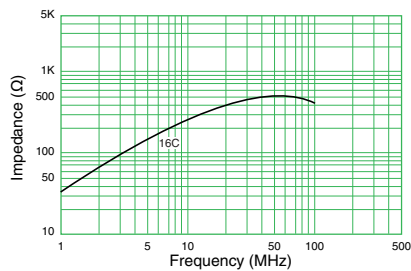

- All specifications in this catalog and production status of products are subject to change without notice. Prior to the purchase, please contact NEC TOKIN for updated product data.
- Please request for a specification sheet for detailed product data prior to the purchase.
- Before using the product in this catalog, please read "Precautions" and other safety precautions listed in the printed version catalog.



# DIP Noise Filters

## D-37C, 40C, 42C, 45C, 47C

[RoHS Compliant]

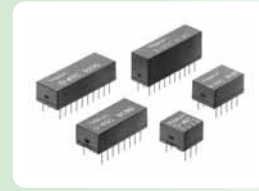

Model	Circuit diagram	Number of terminals/ Circuits	Rated voltage DC (V)	Rated current DC (mA/Line)	DC resistance (mΩ/Line) max.	Operating temperature range (°C)
D-37C		1 core 20P/10 circuits Common mode	50	300	200	-20 to +70
D-40C		1 core 6P/3 circuits Common mode	50	300	200	-20 to +70
D-42C		1 core 10P/5 circuits Common mode	50	300	200	-20 to +70
D-45C		1 core 16P/8 circuits Common mode	50	300	150	-20 to +70
D-47C		1 core 20P/10 circuits Common mode	50	300	200	-20 to +70

• Withstanding voltage: 200VDC (one minute, between lines) • Insulation resistance: more than 10MΩ (100VDC, between lines)

### Shape and Dimensions

●D-37C

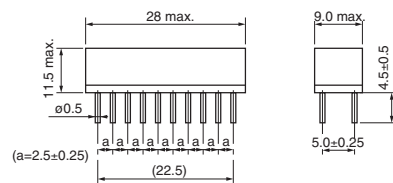

●D-40C, 42C, 45C, 47C

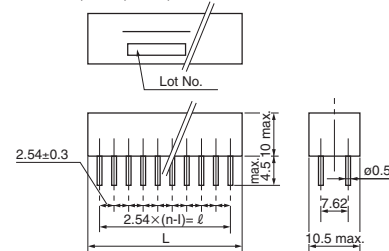

Model	Number of Circuits	ℓ	L
D-40C	3	5.08	12.7 max.
D-42C	5	10.16	18 max.
D-45C	8	17.78	25 max.
D-47C	10	22.86	28 max.

[mm]



- All specifications in this catalog and production status of products are subject to change without notice. Prior to the purchase, please contact NEC TOKIN for updated product data.
- Please request for a specification sheet for detailed product data prior to the purchase.
- Before using the product in this catalog, please read "Precautions" and other safety precautions listed in the printed version catalog.

Impedance vs. Frequency

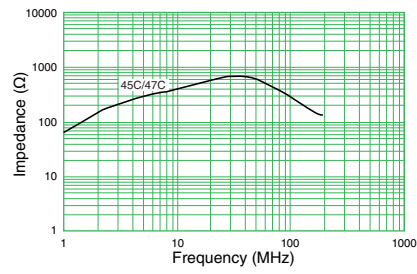
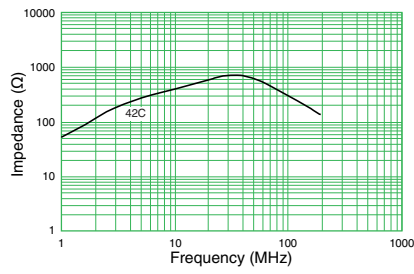
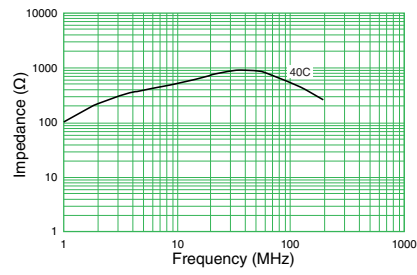
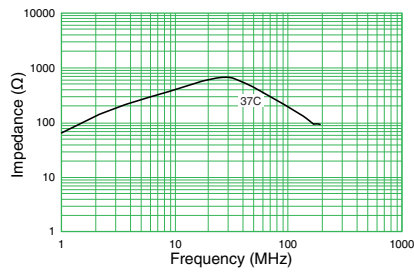

- All specifications in this catalog and production status of products are subject to change without notice. Prior to the purchase, please contact NEC TOKIN for updated product data.
- Please request for a specification sheet for detailed product data prior to the purchase.
- Before using the product in this catalog, please read "Precautions" and other safety precautions listed in the printed version catalog.

# DIP Noise Filters

## D-55C, 58C

[RoHS Compliant]

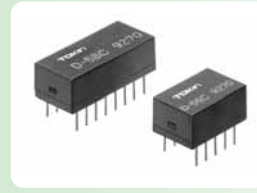

Model	Circuit diagram		Number of terminal/ Circuits	Rated voltage DC (V)	Rated current DC (mA/Line)	DC resistance (mΩ/Line) max.	Operating temperature range (°C)
D-55C		1 core	10P/5 circuits Common mode	50	300	200	-20 to +70
D-58C		1 core	16P/8 circuits Common mode	50	300	200	-20 to +70

- Withstanding voltage: 200VDC (one minute, between lines)
- Insulation resistance: more than 10MΩ (100VDC, between lines)

### Shape and Dimensions

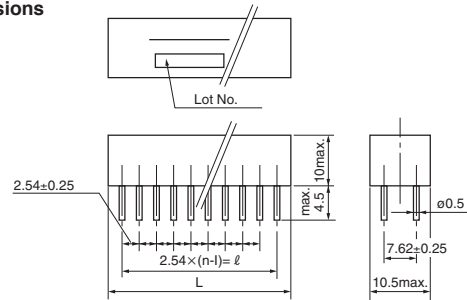

Model	Number of Circuits	ℓ	L
D-55C	5	10.16	18 max.
D-58C	8	17.78	25 max.

[mm]

### Impedance vs. Frequency

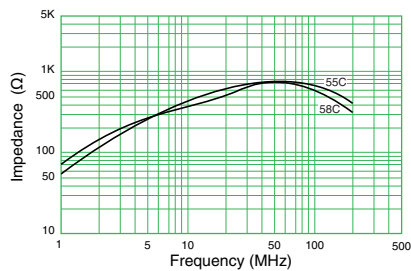

- All specifications in this catalog and production status of products are subject to change without notice. Prior to the purchase, please contact NEC TOKIN for updated product data.
- Please request for a specification sheet for detailed product data prior to the purchase.
- Before using the product in this catalog, please read "Precautions" and other safety precautions listed in the printed version catalog.

# Noise Filters for Telephone Sets

## ST-101, 201, 202, 202S

[RoHS Compliant]



Model	Frequency range (MHz)	Impedance (kΩ) min.	Rated voltage DC (V)	Rated current (mA)	DC resistance (mΩ/Line) max.	Operating temperature range (°C)	Remarks
ST-101	0.5 to 7	3 (at 0.5 MHz)	50	200	180	-20 to +75	AM band
ST-201	7 to 40	1.5 (at 7 MHz)	50	200	100	-20 to +75	FM band
ST-202	7 to 100	0.6 (at 100 MHz)	50	1000	40	-20 to +75	FM band
ST-202S	7 to 100	0.6 (at 100 MHz)	50	1000	35	-20 to +75	FM band

- Withstanding voltage: 500VDC (one minute, between lines) • Insulation resistance: more than 10MΩ (250VDC, between lines)
- Recommended soldering conditions: 350±10°C, 2 to 3 sec.

### Shape and Dimensions/Circuit Diagram

#### ●ST-101, 201

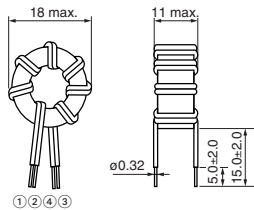

#### ●ST-202

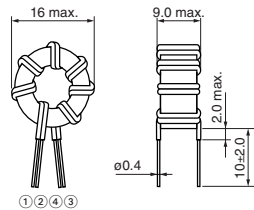

#### ●ST-202S

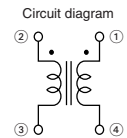
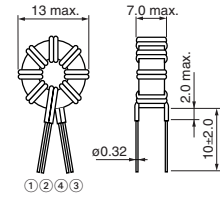

[mm]

### Installation Examples

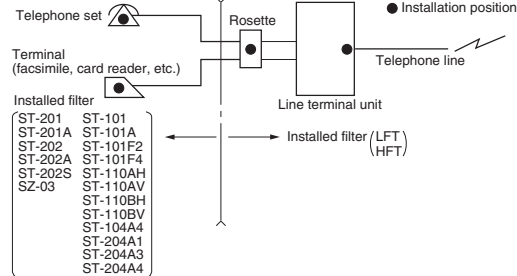

### Design Examples

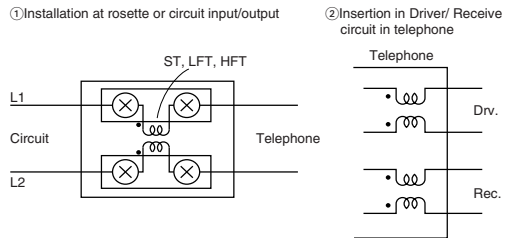

### Impedance vs. Frequency

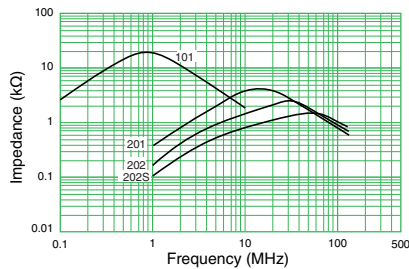

- All specifications in this catalog and production status of products are subject to change without notice. Prior to the purchase, please contact NEC TOKIN for updated product data.
- Please request for a specification sheet for detailed product data prior to the purchase.
- Before using the product in this catalog, please read "Precautions" and other safety precautions listed in the printed version catalog.

# Noise Filters for Telephone Sets

## ST-101A, 201A, 202A

[RoHS Compliant]



Model	Frequency range (MHz)	Impedance (kΩ) min.	Rated voltage DC (V)	Rated current (mA)	DC resistance (mΩ/Line) max.	Operating temperature range (°C)	Remarks
ST-101A	0.5 to 7	3 (at 0.5 MHz)	50	200	250	-20 to +65	AM band
ST-201A	7 to 40	1.5 (at 7 MHz)	50	200	150	-20 to +65	FM band
ST-202A	7 to 100	0.6 (at 100 MHz)	50	1000	50	-20 to +65	FM band

- Withstanding voltage: 500VDC (one minute, between lines)
- Insulation resistance: more than 10MΩ (100VDC, between lines)

### Shape and Dimensions/Circuit Diagram

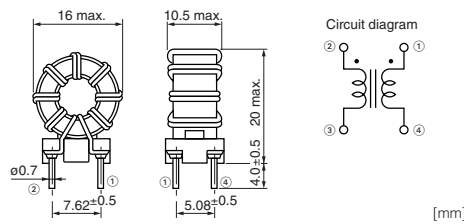

### Installation Examples

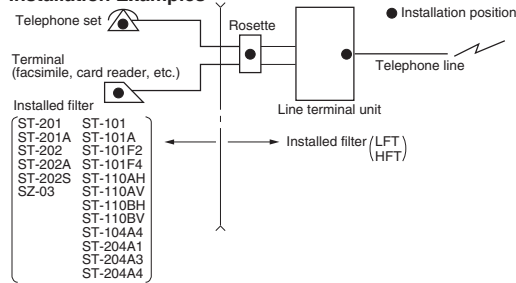

### Design Examples

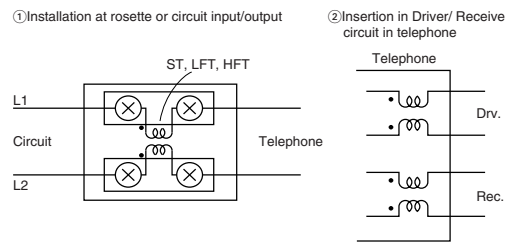

### Impedance vs. Frequency

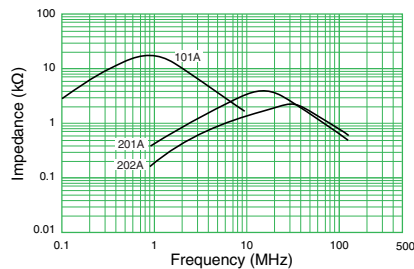

- All specifications in this catalog and production status of products are subject to change without notice. Prior to the purchase, please contact NEC TOKIN for updated product data.
- Please request for a specification sheet for detailed product data prior to the purchase.
- Before using the product in this catalog, please read "Precautions" and other safety precautions listed in the printed version catalog.

# Noise Filters for Telephone Sets

## ST-110AV, 110AH, 110BV, 110BH

[RoHS Compliant]



Model	Frequency range (MHz)	Impedance (kΩ) min.	Rated voltage DC (V)	Rated current (mA)	DC resistance (Ω/Line) max.	Operatings temperature range (°C)	Remarks
ST-110AV	0.5 to 7	27 (at 0.5 MHz)	50	300	3	-20 to +75	AM band
ST-110AH	0.5 to 7	27 (at 0.5 MHz)	50	300	3	-20 to +75	AM band
ST-110BV	0.5 to 7	150 (Resonant)	50	150	7.5	-20 to +75	AM band
ST-110BH	0.5 to 7	150 (Resonant)	50	150	7.5	-20 to +75	AM band

• Withstanding voltage: 500VDC (one minute, between lines) • Insulation resistance: more than 10MΩ (250VDC, between lines)

### Shape and Dimensions/Circuit Diagram

#### ●ST-110AV, ST-110BV

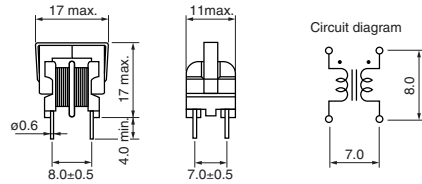

#### ●ST-110AH, ST-110BH

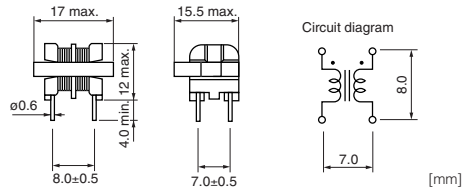

### Installation Examples

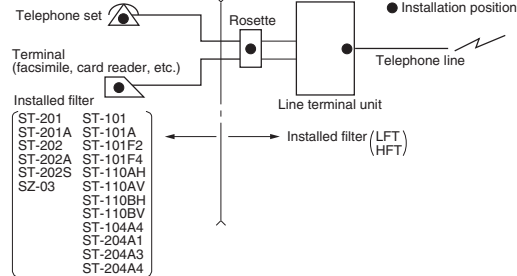

### Design Examples

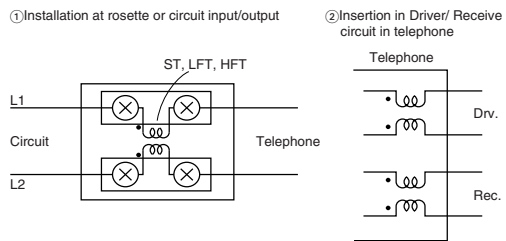

### Impedance vs. Frequency

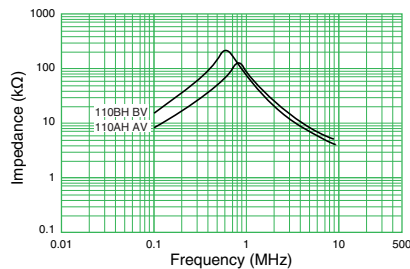

- All specifications in this catalog and production status of products are subject to change without notice. Prior to the purchase, please contact NEC TOKIN for updated product data.
- Please request for a specification sheet for detailed product data prior to the purchase.
- Before using the product in this catalog, please read "Precautions" and other safety precautions listed in the printed version catalog.

# Noise Filters for Telephone Sets

## ST-101F2, 101F4

[RoHS Compliant]



Model	Frequency range (MHz)	Impedance (kΩ) min.	Rated voltage DC (V)	Rated current (mA)	DC resistance (Ω/Line) max.	Operating temperature range (°C)	Remarks
ST-101F2	0.5 to 7	40 (at 600 kHz)	50	200	2.7	-20 to +75	AM band
ST-101F4	0.5 to 7	60 (at 600 kHz)	50	200	3.5	-20 to +75	AM band

• Withstanding voltage: 500VDC (one minute, between lines) • Insulation resistance: more than 10MΩ (250VDC between lines)

### Shape and Dimensions/Circuit Diagram

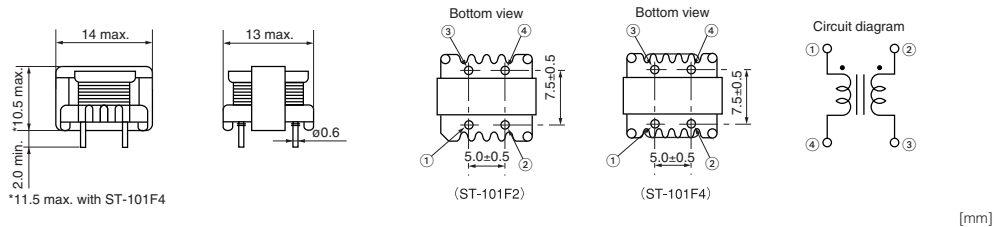

### Installation Examples

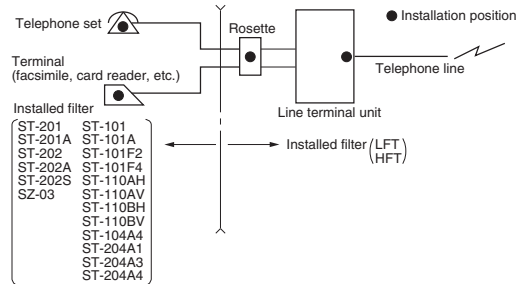

### Design Examples

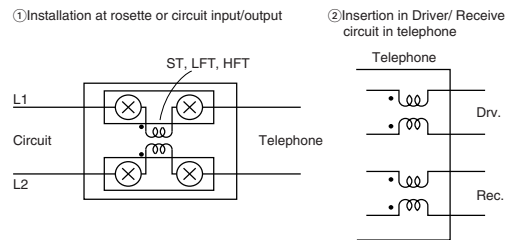

### Impedance vs. Frequency

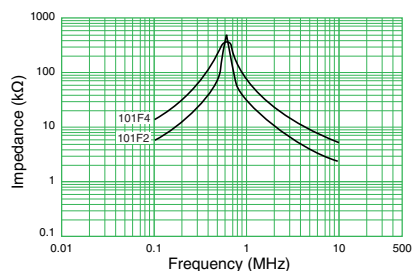

- All specifications in this catalog and production status of products are subject to change without notice. Prior to the purchase, please contact NEC TOKIN for updated product data.
- Please request for a specification sheet for detailed product data prior to the purchase.
- Before using the product in this catalog, please read "Precautions" and other safety precautions listed in the printed version catalog.

# Noise Filters for Telephone Sets

## ST-104A4, 204A Series

[RoHS Compliant]



Model	Frequency range (MHz)	Impedance (kΩ) min.	Rated voltage DC (V)	Rated current (mA)	DC resistance (Ω/Line) max.	Operating temperature range (°C)	Remarks
ST-104A4	0.5 to 7	3.0 (at 0.5 MHz)	50	500	0.36	-20 to +75	AM band
ST-204A1	7 to 100	0.25 (at 10 MHz)	50	500	0.10	-20 to +75	FM band
ST-204A3	7 to 40	1.0 (at 7 MHz)	50	500	0.17	-20 to +75	FM band
ST-204A4	7 to 40	0.6 (at 7 MHz) REF	50	500	0.12	-20 to +75	FM band

• Withstanding voltage: 500VDC (one minute, between lines) • Insulation resistance: more than 10MΩ (250VDC, between lines)

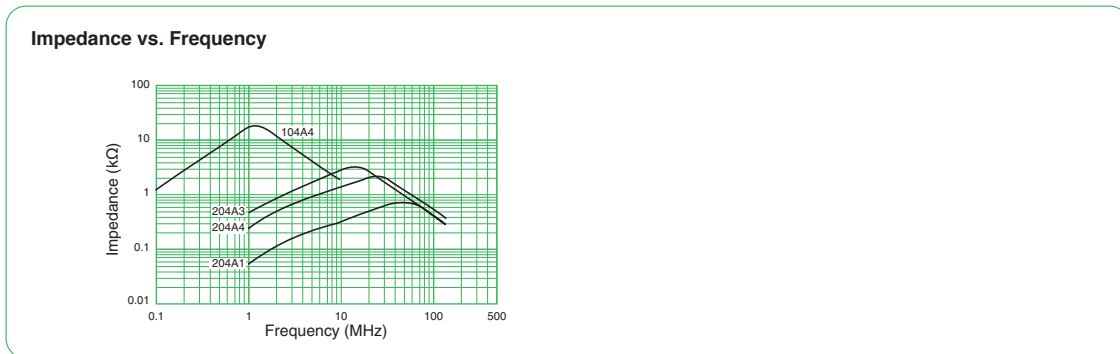
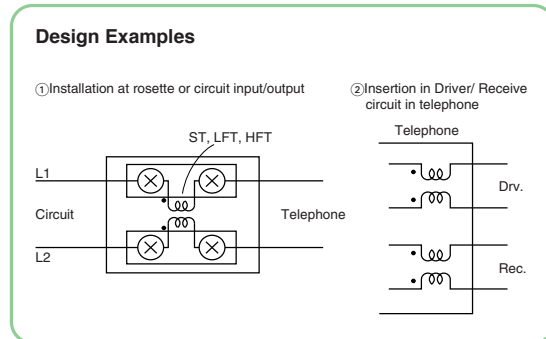
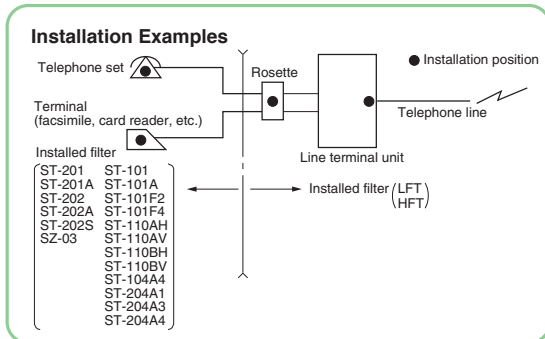
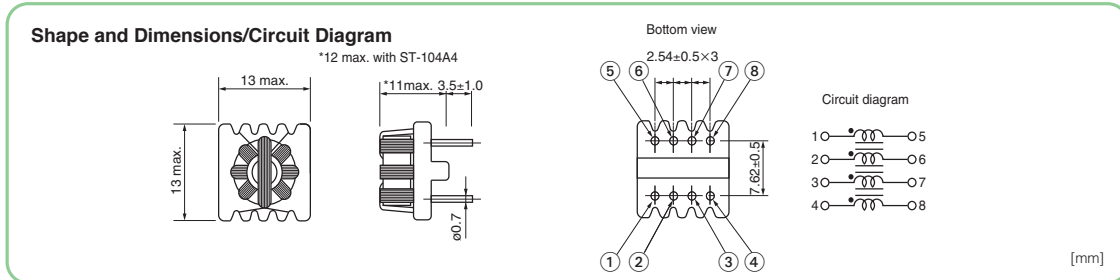

- All specifications in this catalog and production status of products are subject to change without notice. Prior to the purchase, please contact NEC TOKIN for updated product data.
- Please request for a specification sheet for detailed product data prior to the purchase.
- Before using the product in this catalog, please read "Precautions" and other safety precautions listed in the printed version catalog.



# SBT Series

[RoHS Compliant]



• Tape and Reel Dimensions (see page 39)

Model	Rated voltage DC (V)	Rated current (mA)	Inductance (1kHz, 70mA) (μH)	DC resistance (mΩ) max.	Operating temperature range (°C)	Packaging
<b>SBT-0208</b> □	50	500	8±50%	20	-25 to +70	Bulk (100pcs.)
<b>SBT-0210</b> □	50	500	10±50%	20	-25 to +70	
<b>SBT-0240</b> □	50	500	40±35%	34	-25 to +70	
<b>SBT-0260</b> □	50	500	60±35%	50	-25 to +70	

• □ Taping (2000 pcs./ reel x 6), □ Flat taping (1000pcs./ box x 10)

## Shape and Dimensions

● SBT-02□□

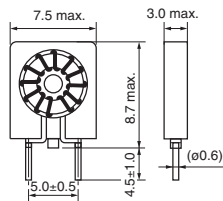

[mm]

## Impedance vs. Frequency

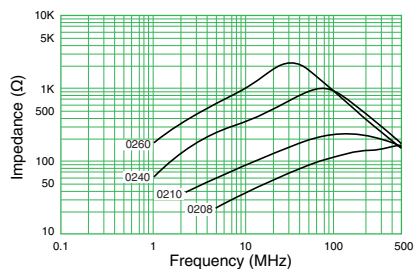

- All specifications in this catalog and production status of products are subject to change without notice. Prior to the purchase, please contact NEC TOKIN for updated product data.
- Please request for a specification sheet for detailed product data prior to the purchase.
- Before using the product in this catalog, please read "Precautions" and other safety precautions listed in the printed version catalog.

# SNT Series

[RoHS Compliant]



• Tape and Reel Dimensions (see page 39)

Model	Rated current* (A)	Inductance (μH) min.	DC resistance (mΩ) max.	Operating temperature range (°C)	Packaging
SNT-S10□	3.0	1.5	25	-20 to +60	Bulk (100 pcs.)
SNT-S20□	1.5	6	35	-20 to +60	
SNT-S30□	0.5	13	95	-20 to +60	
SNT-D10□	3.0	2.5	25	-20 to +60	
SNT-D20□	1.5	10	45	-20 to +60	
SNT-D30□	0.5	20	98	-20 to +60	

\*The rated current is for the wire and it is different from the inductance guaranteeing values.

• □ Taping (1000 pcs./ reel) • □ Flat taping (SNT-S type: 1000 pcs./ reel), (SNT-D type: 500 pcs./ reel)

### Shape and Dimensions

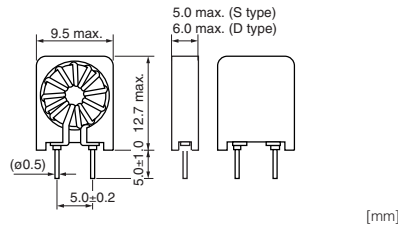

### Design Example

● For noise suppression in the secondary low-voltage power supply circuit

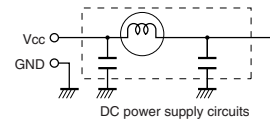

### Impedance vs. Frequency

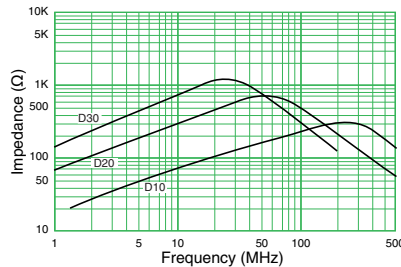
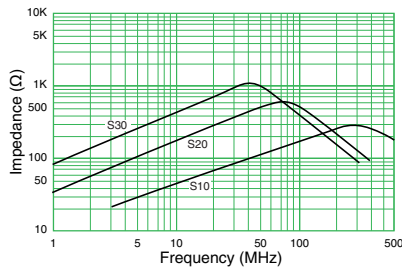

- All specifications in this catalog and production status of products are subject to change without notice. Prior to the purchase, please contact NEC TOKIN for updated product data.
- Please request for a specification sheet for detailed product data prior to the purchase.
- Before using the product in this catalog, please read "Precautions" and other safety precautions listed in the printed version catalog.

# Bead Inductors (Lead Type)

[RoHS Compliant]

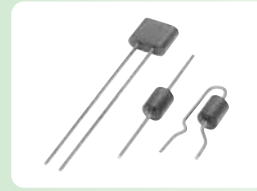

Model	Rated current DC (A)	Impedance (Ω)	Operating temperature range (°C)
<b>B-01-Series</b>	5	2 (at 1 MHz)	-20 to +70
<b>B-02-Series</b>		4 (at 1 MHz)	
<b>B-03-Series</b>		5 (at 1 MHz)	
<b>B-06-Series</b>		40 (at 10 MHz)	

Note: Rated current values are not guaranteed by impedance levels; these values are permissible levels when the lead wire temperature rise is 20°C.

Model	Shape	Packaging
<b>B-01-R</b>	Single-bead, radial-lead	Bulk type (100 pcs./bag)
<b>B-01-RT</b>	Single-bead, radial-lead	Tape type (2000 pcs./reel)
<b>B-01-RTF</b>	Single-bead, radial-lead	Tape type (2000 pcs./box)
<b>B-01-RS</b>	Single-bead, radial-lead	Bulk type (100 pcs./bag)
<b>B-01-RTS</b>	Single-bead, radial-lead	Tape type (2000 pcs./reel)
<b>B-01-RTSF</b>	Single-bead, radial-lead	Tape type (2000 pcs./box)
<b>B-01-A</b>	Single-bead, axial-lead	Bulk type (100 pcs./bag)
<b>B-01-A1</b>	Single-bead, axial-lead	Bulk type (250 pcs./bag)
<b>B-01-A2</b>	Single-bead, axial-lead	Bulk type (250 pcs./bag)
<b>B-01-AT</b>	Single-bead, axial-lead	Tape type (5000 pcs./reel)
<b>B-01-ATF</b>	Single-bead, axial-lead	Tape type (1500 pcs./box)
<b>B-01-AT1F</b>	Single-bead, axial-lead	Tape type (2000 pcs./box)
<b>B-02-R</b>	Double-bead, radial-lead	Bulk type (100 pcs./bag)
<b>B-02-RT</b>	Double-bead, radial-lead	Tape type (2000 pcs./reel)
<b>B-02-RTF</b>	Double-bead, radial-lead	Tape type (1500 pcs./box)
<b>B-03-R</b>	Double-bead, radial-lead	Bulk type (100 pcs./bag)
<b>B-03-RT</b>	Double-bead, radial-lead	Tape type (2000 pcs./reel)
<b>B-06-R-25</b>	Double-bead, radial-lead	Bulk type (100 pcs./bag)
<b>B-06-RTF-25</b>	Double-bead, radial-lead	Tape type (1500 pcs./reel)
<b>B-06-R-50</b>	Double-bead, radial-lead	Bulk type (100 pcs./bag)
<b>B-06-RTF-50</b>	Double-bead, radial-lead	Tape type (1500 pcs./box)

## Impedance Characteristics

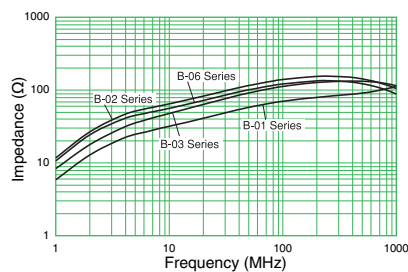

- All specifications in this catalog and production status of products are subject to change without notice. Prior to the purchase, please contact NEC TOKIN for updated product data.
- Please request for a specification sheet for detailed product data prior to the purchase.
- Before using the product in this catalog, please read "Precautions" and other safety precautions listed in the printed version catalog.

Shape and Dimensions

●B-01-R Series

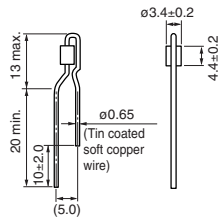

●B-02-R Series

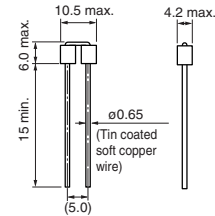

●B-06-R-25 Series

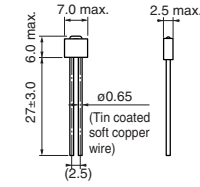

●B-01-RS Series

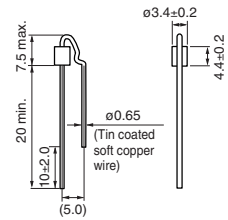

●B-03-R Series

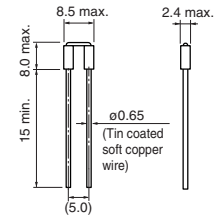

●B-06-R-50 Series

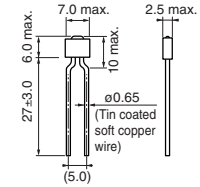

●B-01-A Series

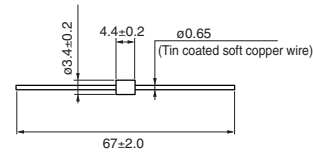

●B-01-A1

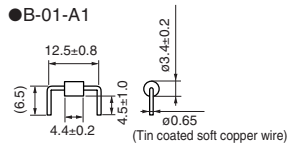

●B-01-A2

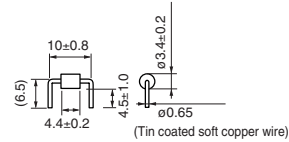

[mm]



- All specifications in this catalog and production status of products are subject to change without notice. Prior to the purchase, please contact NEC TOKIN for updated product data.
- Please request for a specification sheet for detailed product data prior to the purchase.
- Before using the product in this catalog, please read "Precautions" and other safety precautions listed in the printed version catalog.

Tape and Reel Dimensions

●B-01-RT • RTF

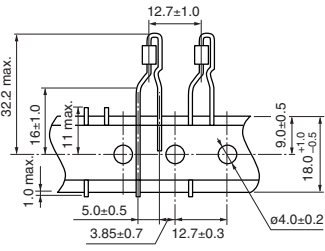

●B-02-RT • RTF/B-03-RT

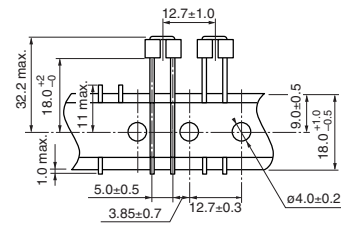

●B-01-RTS • RTSF

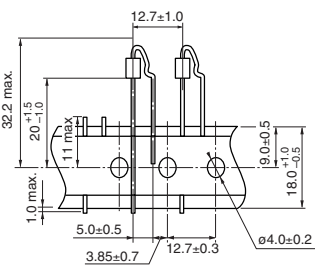

●B-06-RTF-25

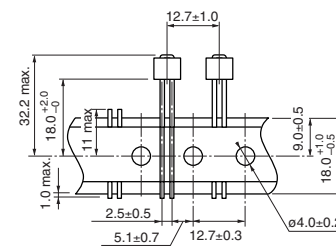

●B-01-AT • ATF

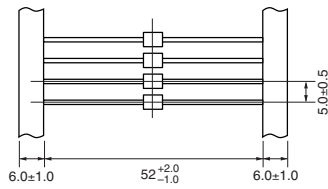

●B-06-RTF-50

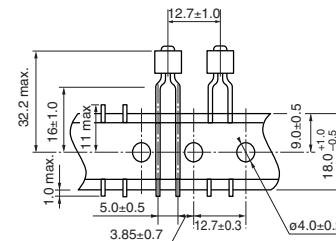

●B-01-AT1F

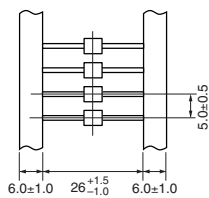

[mm]



- All specifications in this catalog and production status of products are subject to change without notice. Prior to the purchase, please contact NEC TOKIN for updated product data.
- Please request for a specification sheet for detailed product data prior to the purchase.
- Before using the product in this catalog, please read "Precautions" and other safety precautions listed in the printed version catalog.

# Bead Inductors (Winding Type)

[RoHS Compliant]



Model	Core	Wire	No. of turns
B-1	B-20F-28	Teflon wire (ø0.26 : single) / Color: White	2T
B-3	B-20L-48B	Teflon wire (ø0.51 : single) / Color: Red	2T
B-4	B-20L-44	Teflon wire (ø0.26 : single) / Color: White	2T
B-5	B-20L-44	Teflon wire (ø0.26 : single) / Color: White	3T
B-7	B-20F-28	Teflon wire (ø0.32 : single) / Color: Green	2T
B-8	B-20L-48B	Teflon wire (ø0.4 : single) / Color: Blue	2T
B-9	B-20L-48B	Teflon wire (ø0.4 : single) / Color: Yellow	3T
B-10	B-20L-48B	Teflon wire (ø0.4 : single) / Color: Black	4T
B-6-22B	—	Soft copper wire (ø0.6)	—
B-6-31B	—	Soft copper wire (ø0.6)	—

## Shape and Dimensions

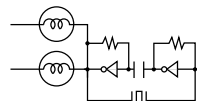

(Clock pulse oscillating section)

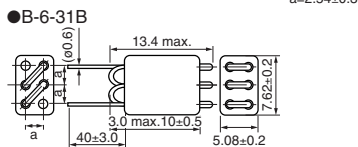
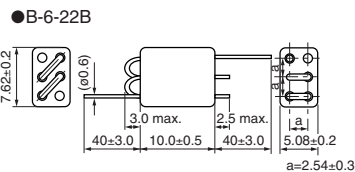

●B-1,3,4,5,7

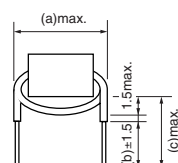

●B-8,9,10

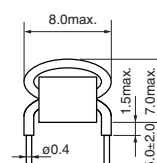

Model	(a)	(b)	(c)
B-1	5.5	5	9
B-3	9	5	10
B-4	10.5	5	9
B-5	11	5	9
B-7	6	5	9

[mm]

## Impedance vs. Frequency

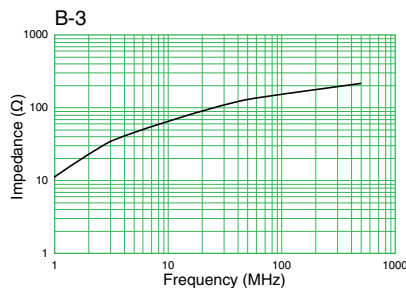
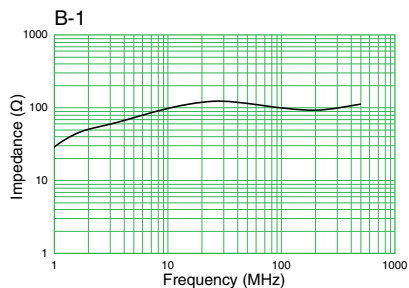

- All specifications in this catalog and production status of products are subject to change without notice. Prior to the purchase, please contact NEC TOKIN for updated product data.
- Please request for a specification sheet for detailed product data prior to the purchase.
- Before using the product in this catalog, please read "Precautions" and other safety precautions listed in the printed version catalog.

Impedance vs. Frequency

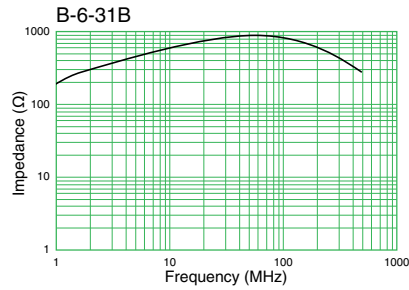
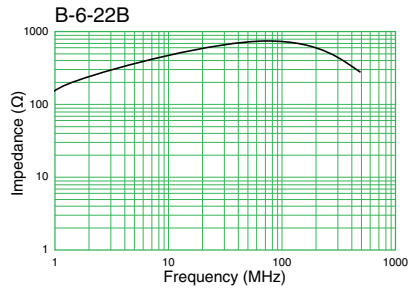
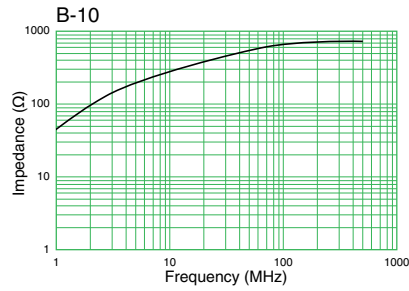
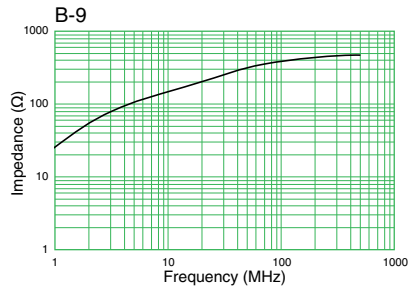
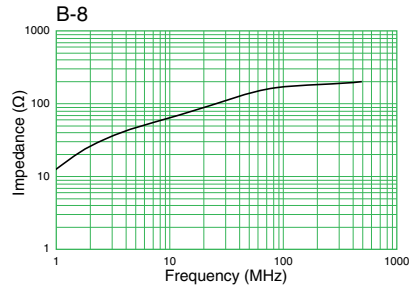
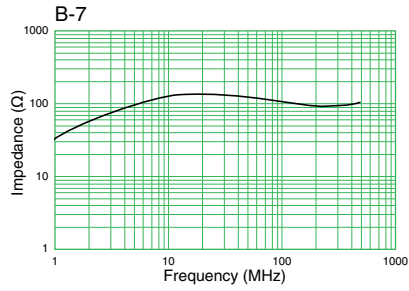
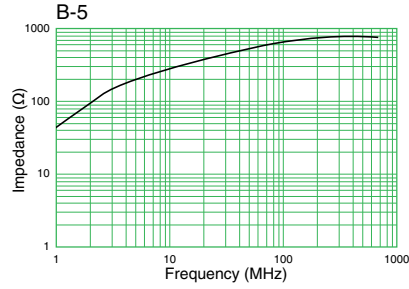
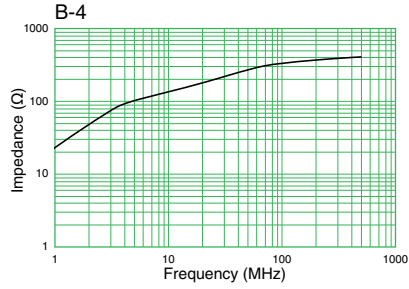

- All specifications in this catalog and production status of products are subject to change without notice. Prior to the purchase, please contact NEC TOKIN for updated product data.
- Please request for a specification sheet for detailed product data prior to the purchase.
- Before using the product in this catalog, please read "Precautions" and other safety precautions listed in the printed version catalog.

# DFD Series

[RoHS Compliant]



Model	Rated voltage DC (V)	Rated current DC (A)	DC resistance (mΩ) max.	Operating temperature range (°C)
<b>DFD-104P</b>	50	2.0	100	-25 to +85
<b>DFD-104S</b>	50	2.0	100	-25 to +85

• Withstanding voltage: 125VDC, 5 sec. between terminal 1 and 2 • Insulation resistance: more than 500MΩ (100VDC, one minute)

## Shape and Dimensions/Circuit Diagram

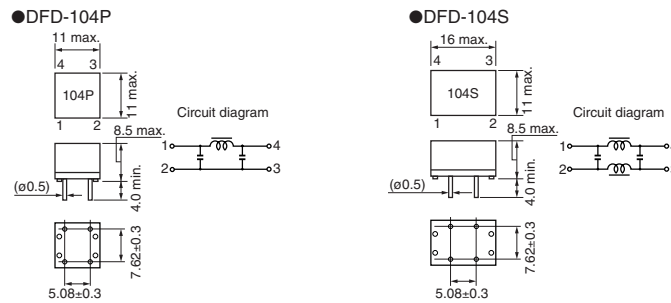

[mm]

## Attenuation Characteristics

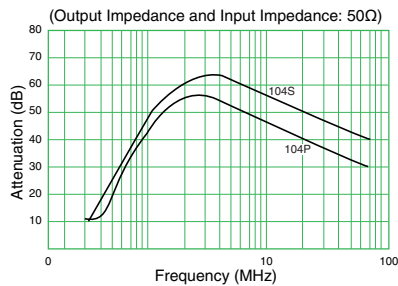

- All specifications in this catalog and production status of products are subject to change without notice. Prior to the purchase, please contact NEC TOKIN for updated product data.
- Please request for a specification sheet for detailed product data prior to the purchase.
- Before using the product in this catalog, please read "Precautions" and other safety precautions listed in the printed version catalog.



## Tape and Reel Dimensions

## SBT Series

## Tape and Reel Dimensions

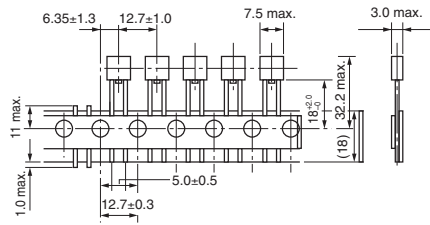

## SNT Series

## Tape and Reel Dimensions

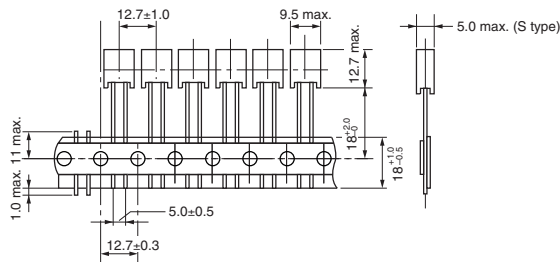

- All specifications in this catalog and production status of products are subject to change without notice. Prior to the purchase, please contact NEC TOKIN for updated product data.
- Please request for a specification sheet for detailed product data prior to the purchase.
- Before using the product in this catalog, please read "Precautions" and other safety precautions listed in the printed version catalog.

# SBS9080 Series

[RoHS Compliant]



- Tape and Reel Dimensions (see page 44)
- Precautions (see page 43)

Model	Rated voltage DC (V)	Rated current DC (A)	Inductance (at 100KHz) ( $\mu$ H) min.	DC resistance (m $\Omega$ /line) max.	Operating temperature range ( $^{\circ}$ C)
<b>SBS9080-509T</b>	50	5.0	0.9	15	-25 to +50
<b>SBS9080-524T</b>	50	5.0	2.4	15	-25 to +50

- Withstanding voltage: 125V DC for one minute between lines
- Insulation resistance: More than 10MQ (100V DC, between lines)

### Shape and Dimensions

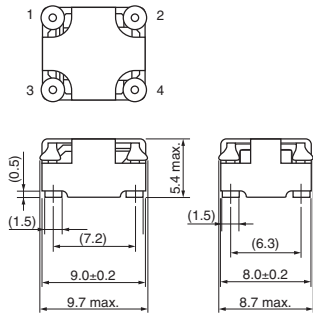

[mm]

### Circuit Diagram

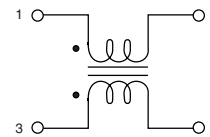

### Recommended Land Pattern

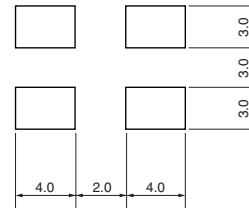

[mm]

### Impedance vs. Frequency

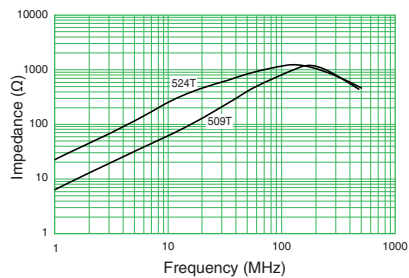

- All specifications in this catalog and production status of products are subject to change without notice. Prior to the purchase, please contact NEC TOKIN for updated product data.
- Please request for a specification sheet for detailed product data prior to the purchase.
- Before using the product in this catalog, please read "Precautions" and other safety precautions listed in the printed version catalog.

# SBP Series

[RoHS Compliant]



- Tape and Reel Dimensions (see page 44)
- Precautions (see page 43)

Model	Rated voltage DC (V)	Rated current DC (A)	Impedance (at 100MHz) ( $\Omega$ ) min.	DC resistance (m $\Omega$ /line) max.	Operating temperature range ( $^{\circ}$ C)
<b>SBP-5001T</b>	50	5.0	500	7	-25 to +70

- Withstanding voltage: 200V DC for one minute between lines
- Insulation resistance: More than 10M $\Omega$  (100V DC, between lines)

## Shape and Dimensions

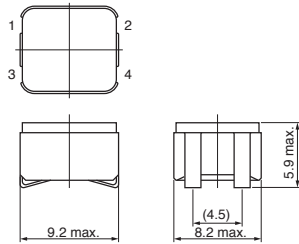

[mm]

## Circuit Diagram

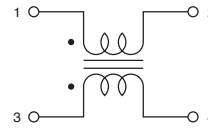

## Recommended Land Pattern

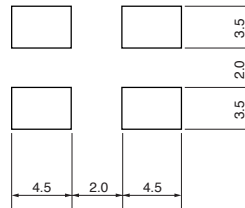

[mm]

## Impedance vs. Frequency

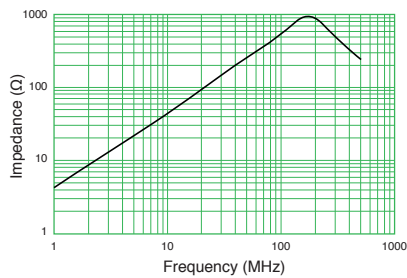

- All specifications in this catalog and production status of products are subject to change without notice. Prior to the purchase, please contact NEC TOKIN for updated product data.
- Please request for a specification sheet for detailed product data prior to the purchase.
- Before using the product in this catalog, please read "Precautions" and other safety precautions listed in the printed version catalog.

# DCM Series

[RoHS Compliant]



• Tape and Reel Dimensions (see page 46) • Precautions (see page 43)

Model	Rated voltage (V)	Rated current (A)	L (μH) min	Rdc (mΩ) max	Type
DCM5-01	50	0.2	2540	3180	EE5
DCM5-02	50	0.5	520	510	EE5
DCM5-03	50	1.0	210	180	EE5
DCM5-04	50	2.0	30	30	EE5

● Inductance measurement condition : f = 10KHZ 0.1V ※● Insulation resistance : more than 100MΩ (250V DC, 1min, between lines) ● Operating temperature range(°C) : -20 to 110 (includes the selftemp.rise)  
**Look :** By number-of-turns adjustment, to products other than the above-mentioned characteristic is also possible, please consult.  
 ● Common mode winding with section bobbin. ※● Withstanding voltage : 250V DC for one minute between lines.

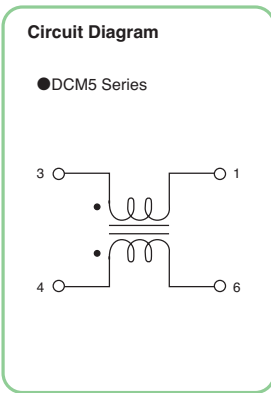
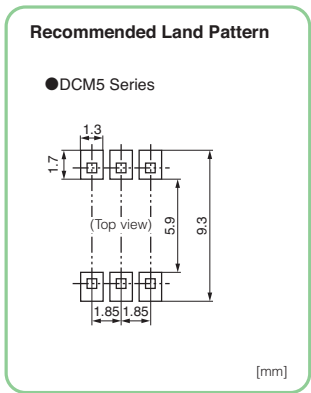
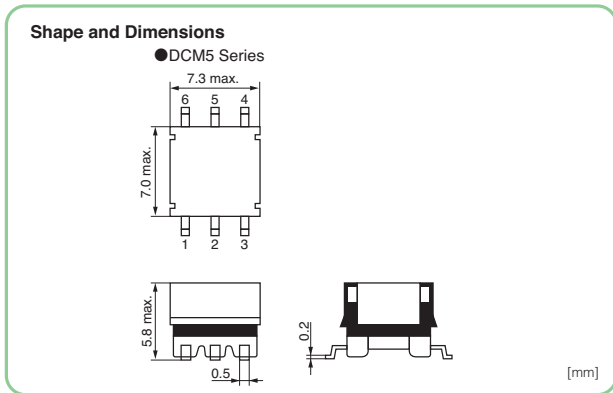

- All specifications in this catalog and production status of products are subject to change without notice. Prior to the purchase, please contact NEC TOKIN for updated product data.
- Please request for a specification sheet for detailed product data prior to the purchase.
- Before using the product in this catalog, please read "Precautions" and other safety precautions listed in the printed version catalog.

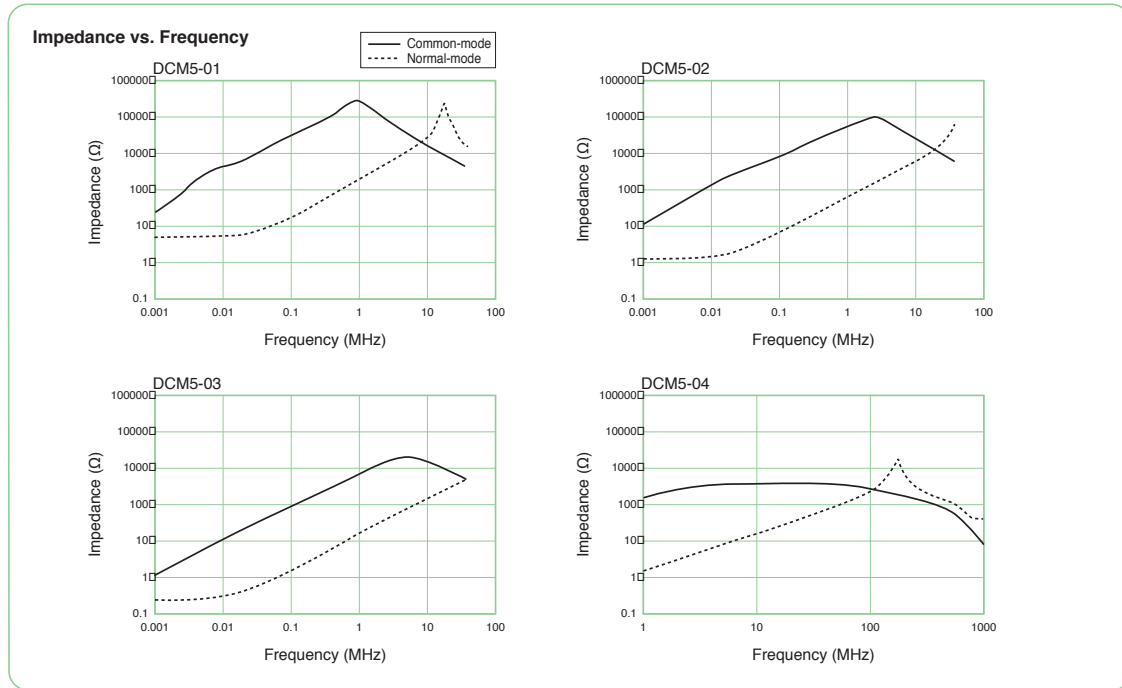

- All specifications in this catalog and production status of products are subject to change without notice. Prior to the purchase, please contact NEC TOKIN for updated product data.
- Please request for a specification sheet for detailed product data prior to the purchase.
- Before using the product in this catalog, please read "Precautions" and other safety precautions listed in the printed version catalog.

# EMC Chip Filters M-500CT/M-600T Series

[RoHS Compliant]

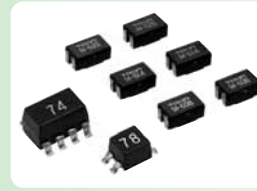

- Tape and Reel Dimensions (see page 44-46)
- Precautions (see page 43)

### M-500CT Series

Model	Rated voltage DC (V)	Rated current DC (A)	Impedance (Ω) min.	DC resistance (mΩ) max.	Operating temperature range (°C)
M-521CT	50	1.0	700 (at 10 MHz)	100	-25 to +85
M-522CT	50	1.0	200 (at 20 MHz)	100	-25 to +85
M-523CT	50	1.5	200 (at 20 MHz)	65	-25 to +85
M-524CT	80	0.5	700 (at 10 MHz)	100	-25 to +85
M-532CT	50	0.5	450 (at 100 MHz)	90	-25 to +85
M-538CT	50	0.1	800 (at 100 MHz)	220	-25 to +70
M-542CT	50	0.5	200 (at 10 MHz)	120	-20 to +75
M-543CT	50	1.0	700 (at 10 MHz)	100	-25 to +85

### M-600T Series

Model	Rated voltage DC (V)	Rated current DC (A)	Impedance (Ω) min.	DC resistance (mΩ) max.	Operating temperature range (°C)
M-608T	50	0.1	300 (at 100 MHz)	80	-20 to +80
M-614T	50	0.1	1000 (at 50 MHz)	120	-20 to +80
M-620T	50	0.1	1000 (at 30 MHz)	160	-20 to +80

- Insulation resistance: more than 10MΩ (100V DC, between lines)

### Shape and Dimensions

#### ●M-521CT, M-522CT, M-523CT, M-524CT

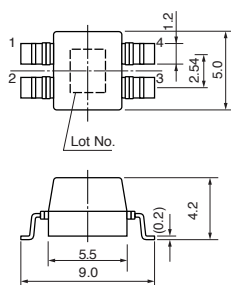

#### ●M-532CT

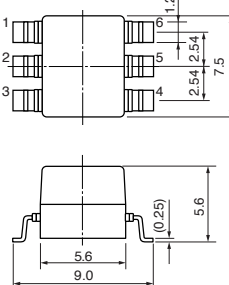

#### ●M-538CT

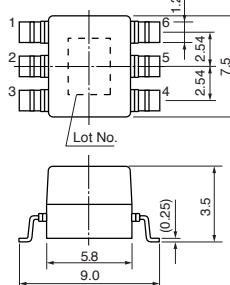

#### ●M-542CT

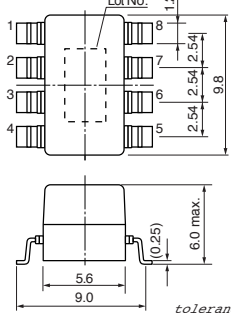

#### ●M-543CT

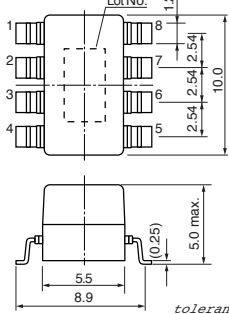

#### ●M-608T, M-614T, M-620T

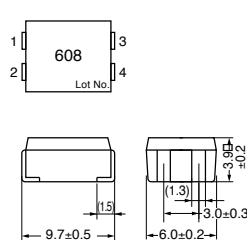

tolerance±0.2

tolerance±0.2

[mm]



- All specifications in this catalog and production status of products are subject to change without notice. Prior to the purchase, please contact NEC TOKIN for updated product data.
- Please request for a specification sheet for detailed product data prior to the purchase.
- Before using the product in this catalog, please read "Precautions" and other safety precautions listed in the printed version catalog.

Circuit Diagram

●M-521CT, M-522CT, M-523CT, M-524CT

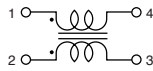

●M-532CT, M-538CT

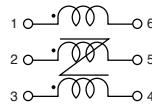

●M-542CT

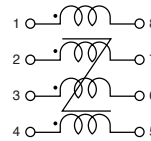

●M-543CT

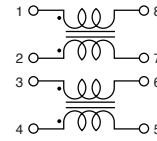

●M-608T, M-614T, M-620T

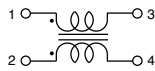

Recommended Land Pattern

●M-521CT, M-522CT  
M-523CT, M-524CT

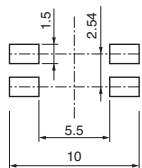

●M-538CT, M-532CT

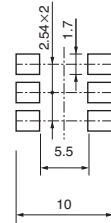

●M-542CT, M-543CT

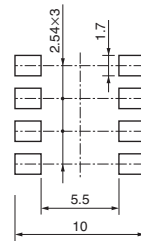

●M-608T, M-614T, M-620T

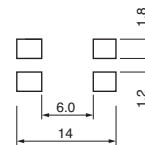

[mm]

Impedance vs. Frequency

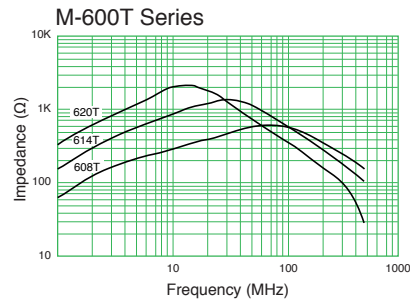
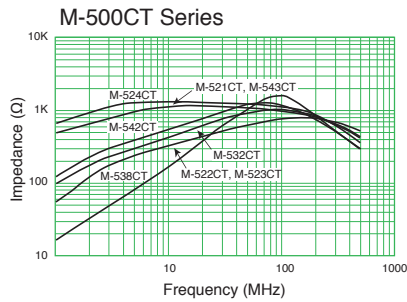

- All specifications in this catalog and production status of products are subject to change without notice. Prior to the purchase, please contact NEC TOKIN for updated product data.
- Please request for a specification sheet for detailed product data prior to the purchase.
- Before using the product in this catalog, please read "Precautions" and other safety precautions listed in the printed version catalog.

**Precautions**

**Shelf Life**

Use within 6 months. If the product is used after a storage period of 6 months or longer, confirm its solderability before use.

**Recommended Soldering Conditions**

- Soldering irons:  
Tip temperature: 350±5°C  
Duration of heat: approx. 4 seconds
  - Flow soldering: not suitable
  - Reflow soldering: Refer to the following temperature profile.
  - Standard thickness of cream Solder = 150 μm ~ 200 μm.
- Recommended reflow profile shown below are data obtained from reflow equipment used at NEC TOKIN. The Solderability may differ greatly depending on reflow equipment type, reflow condition, land pattern area and the amount of cream Solder. Please check the Solderability thoroughly before actual reflow operation.

**Reflow Profile 1 (for SBP-5001T)**

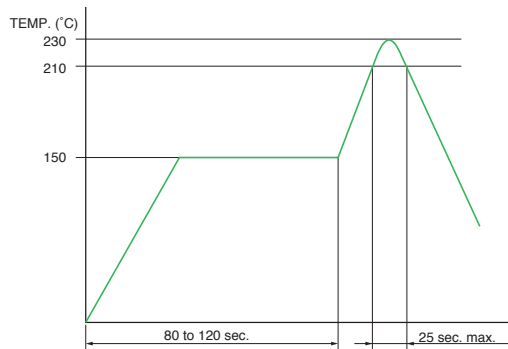

**Reflow Profile 2 (for lead-free type)**

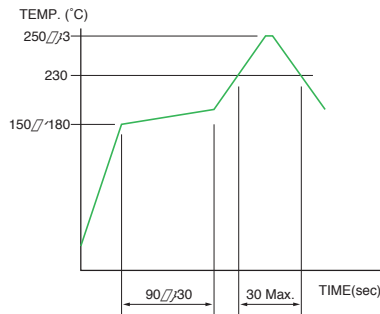

- All specifications in this catalog and production status of products are subject to change without notice. Prior to the purchase, please contact NEC TOKIN for updated product data.
- Please request for a specification sheet for detailed product data prior to the purchase.
- Before using the product in this catalog, please read "Precautions" and other safety precautions listed in the printed version catalog.



**Tape and Reel Dimensions**

**SBS9080 (1000pcs./reel)**

Dimensions of indented square-hole plastic tape

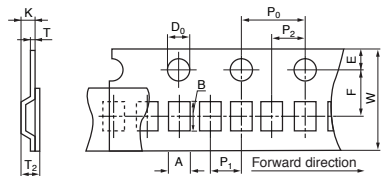

[mm]												
A <sub>0</sub>	B <sub>0</sub>	W	F	E	P <sub>1</sub>	P <sub>2</sub>	P <sub>0</sub>	D <sub>0</sub>	T <sub>1</sub>	T <sub>2</sub>	K	
±0.3	±0.3	±0.3	±0.1	±0.1	±0.1	±0.1	±0.1	+0.1, -0	0.6 $\geq$	7.2 $\geq$	7.0 $\geq$	
9.5	10.3	16	7.5	1.75	12	2.0	4.0	1.5	0.6	7.2	7.0	

Reel dimensions

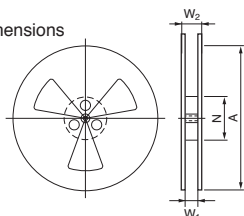

[mm]			
A	N	W <sub>1</sub>	W <sub>2</sub>
330	100	±0.5	25 $\geq$
		17.5	25

**SBP-5001T (1000pcs./reel)**

Dimensions of indented square-hole plastic tape

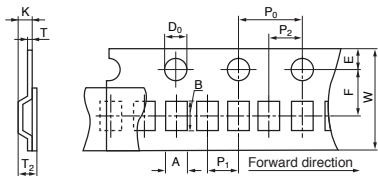

[mm]												
A	B	W	F	E	P <sub>1</sub>	P <sub>2</sub>	P <sub>0</sub>	D <sub>0</sub>	T <sub>1</sub>	T <sub>2</sub>	K	
±0.3	±0.3	±0.3	±0.1	±0.1	±0.1	±0.1	±0.1	+0.1, -0	0.4 $\geq$	5.7 $\geq$	5.8 $\geq$	
9.0	9.0	16	7.5	1.75	12	2.0	4.0	1.5	0.4	5.7	5.8	

Reel dimensions

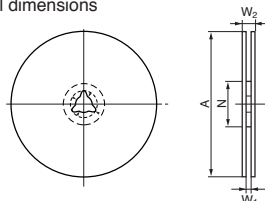

[mm]			
A	N	W <sub>1</sub>	W <sub>2</sub>
330	79	+6, -0	25 $\geq$
		16	25

**M-521CT/M-522CT/M-523CT/M-524CT (conforms to EIAJ RC-1009) (1500pcs./reel)**

Dimensions of indented square-hole plastic tape

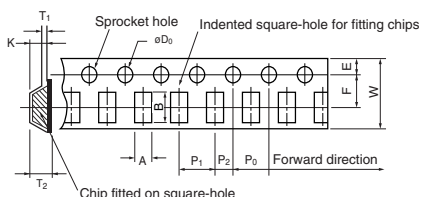

[mm]												
A	B	W	F	E	P <sub>1</sub>	P <sub>2</sub>	P <sub>0</sub>	D <sub>0</sub>	T <sub>1</sub>	T <sub>2</sub>	K	
±0.3	±0.3	±0.3	±0.1	±0.1	±0.1	±0.1	±0.1	+0.1, -0	max.	max.	max.	
5.3	9.5	16	7.5	1.75	8.0	2.0	4.0	1.5	0.6	6.5	6.4	

Reel dimensions

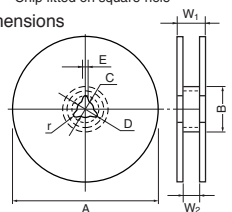

[mm]								
A	B	C	D	E	r	W <sub>1</sub>	W <sub>2</sub>	
±3.0	±2.0	±0.2	±0.8	±0.5	—	max.	+6, -0	
330	79	13	21	2.0	1.0	25	16	



- All specifications in this catalog and production status of products are subject to change without notice. Prior to the purchase, please contact NEC TOKIN for updated product data.
- Please request for a specification sheet for detailed product data prior to the purchase.
- Before using the product in this catalog, please read "Precautions" and other safety precautions listed in the printed version catalog.

**M-532CT (conforms to EIAJ RC-1009) (1000pcs/reel)**

Dimensions of indented square-hole plastic tape

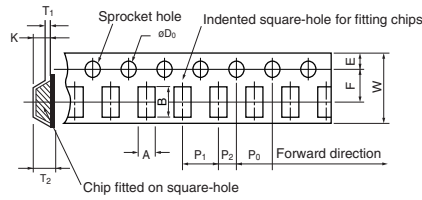

[mm]											
A	B	W	F	E	P <sub>1</sub>	P <sub>2</sub>	P <sub>0</sub>	D <sub>0</sub>	T <sub>1</sub>	T <sub>2</sub>	K
±0.3	±0.3	±0.3	±0.1	±0.1	±0.1	±0.1	±0.1	+0.1, -0	max.	max.	max.
7.9	9.4	16.0	7.5	1.75	12.0	2.0	4.0	1.5	0.6	6.9	6.8

Reel dimensions

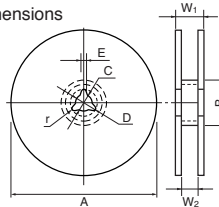

[mm]							
A	B	C	D	E	r	W <sub>1</sub>	W <sub>2</sub>
±3.0	±2.0	±0.2	±0.8	±0.5	—	max.	+6, -0
330	80	13.0	21.0	2.0	1.0	25.0	16.0

**M-538CT (conforms to EIAJ RC-1009) (1500pcs/reel)**

Dimensions of indented square-hole plastic tape

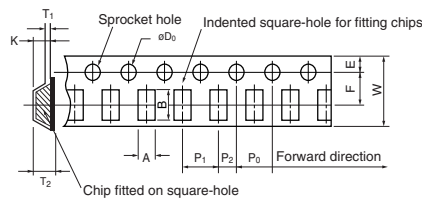

[mm]											
A	B	W	F	E	P <sub>1</sub>	P <sub>2</sub>	P <sub>0</sub>	D <sub>0</sub>	T <sub>1</sub>	T <sub>2</sub>	K
±0.3	±0.3	±0.3	±0.1	±0.1	±0.1	±0.1	±0.1	+0.1, -0	max.	max.	max.
7.9	9.4	16.0	7.5	1.75	12.0	2.0	4.0	1.5	0.6	4.6	4.5

Reel dimensions

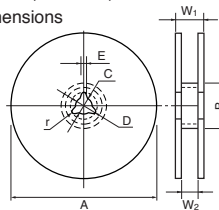

[mm]							
A	B	C	D	E	r	W <sub>1</sub>	W <sub>2</sub>
±3.0	±2.0	±0.2	±0.8	±0.5	—	max.	+6, -0
330	80	13.0	21.0	2.0	1.0	25.0	16.0

**M-542CT (conforms to EIAJ RC-1009) (1000pcs/reel)**

Dimensions of indented square-hole plastic tape

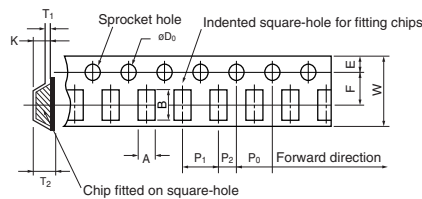

[mm]											
A	B	W	F	E	P <sub>1</sub>	P <sub>2</sub>	P <sub>0</sub>	D <sub>0</sub>	T <sub>1</sub>	T <sub>2</sub>	K
±0.3	±0.3	±0.3	±0.1	±0.1	±0.1	±0.1	±0.1	+0.1, -0	max.	max.	max.
9.5	10.5	16.0	7.5	1.75	12.0	2.0	4.0	1.5	0.6	7.2	7.0

Reel dimensions

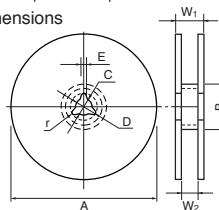

[mm]							
A	B	C	D	E	r	W <sub>1</sub>	W <sub>2</sub>
±3.0	±2.0	±0.2	±0.8	±0.5	—	max.	+6, -0
330	100	13.0	21.0	2.0	1.0	25.0	17.5±0.5



- All specifications in this catalog and production status of products are subject to change without notice. Prior to the purchase, please contact NEC TOKIN for updated product data.
- Please request for a specification sheet for detailed product data prior to the purchase.
- Before using the product in this catalog, please read "Precautions" and other safety precautions listed in the printed version catalog.

**M-608T/M-614T/M-620T (conforms to EIAJ RC-1009) (1500pcs./reel)**

Dimensions of indented square-hole plastic tape

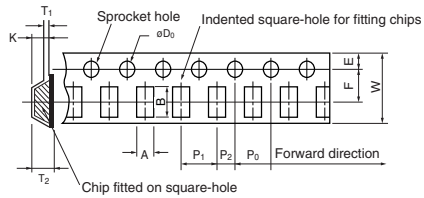

A	B	W	F	E	P <sub>1</sub>	P <sub>2</sub>	P <sub>0</sub>	D <sub>0</sub>	T <sub>1</sub>	T <sub>2</sub>	K
±0.3	±0.3	±0.3	±0.1	±0.1	±0.1	±0.1	±0.1	+0.1, -0	max.	max.	max.
6.4	10.2	16.0	7.5	1.75	8.0	2.0	4.0	1.5	0.6	6.5	6.4

Reel dimensions

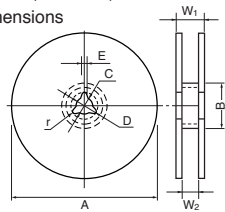

A	B	C	D	E	r	W <sub>1</sub>	W <sub>2</sub>
±3.0	±2.0	±0.2	±0.8	±0.5	—	max.	+6, -0
330	79	13.0	21.0	2.0	1.0	25.0	16.0

**DCM5 Series(2000pcs./reel)**

Dimensions of indented square-hole plastic tape

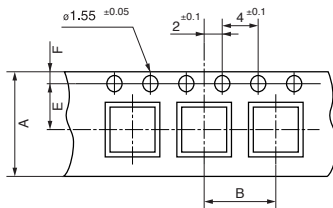

Mode 1	Mode 2	B	C	D	E	F	G	H
DCM5 Series	16±0.3	8	6.3	8.3	7.5	1.75	5.2	0.38±0.05

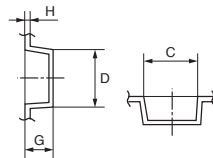

- All specifications in this catalog and production status of products are subject to change without notice. Prior to the purchase, please contact NEC TOKIN for updated product data.
- Please request for a specification sheet for detailed product data prior to the purchase.
- Before using the product in this catalog, please read "Precautions" and other safety precautions listed in the printed version catalog.



- All specifications in this catalog and production status of products are subject to change without notice. Prior to the purchase, please contact NEC TOKIN for updated product data.
- Please request for a specification sheet for detailed product data prior to the purchase.
- Before using the product in this catalog, please read "Precautions" and other safety precautions listed in the printed version catalog.

# Precautions



- The names of the products and the specifications in this catalog are subject to change without notice for the sake of improvement. The manufacturer also reserves the right to discontinue any of these products. At the time of delivery, please ask for specifications sheets to check the contents in order to use the products properly and safely.
- Descriptions in this catalog regarding product characteristics and quality are based solely on discrete components. When using these components, be sure to check the specifications with the component in question mounted on the products.
- The manufacturer's warranty will not cover any disadvantage or damage caused by improper use of the products that deviates from the characteristics, specifications, or conditions for use described in this catalog.
- The products in this catalog are intended for use in ordinary electronic products. If any of these products are to be used in special applications requiring extremely high reliability, such as in aviation equipment and nuclear power controllers where product defects might pose a safety risk, please consult your NEC TOKIN sales representatives.
- Though the manufacturer has taken all possible precautions to ensure the quality and reliability of its products, improper use of products may result in bodily injury, fire, or similar accident. If you have any questions regarding the use of the products in question, please consult your NEC TOKIN sales representatives.
- Please be advised that the manufacturer accepts no responsibility for any infraction by users of the manufacturer's products on third party patents or industrial copyrights. The manufacturer is responsible only when such infractions are attributable to the structural design of the product and its manufacturing process.
- Export Control  
For customers outside Japan  
NEC TOKIN products should not be used or sold for use in the development, production, stockpiling or utilization of any conventional weapons or mass-destructive weapons (nuclear weapons, chemical or biological weapons, or missiles), or any other weapons.  
For customers in Japan  
For products which are controlled items subject to the "Foreign Exchange and Foreign Trade Law" of Japan, the export license specified by the law is required for export.
- This catalog is current as of June 2011.



- All specifications in this catalog and production status of products are subject to change without notice. Prior to the purchase, please contact NEC TOKIN for updated product data.
- Please request for a specification sheet for detailed product data prior to the purchase.
- Before using the product in this catalog, please read "Precautions" and other safety precautions listed in the printed version catalog.