

## Features

- Low On-Resistance
  - 100 mΩ @  $V_{GS} = -4.5V$
  - 120 mΩ @  $V_{GS} = -2.5V$
  - 160 mΩ @  $V_{GS} = -1.8V$
- Very Low Gate Threshold Voltage  $V_{GS(th)} \leq 1V$
- Low Input Capacitance
- Fast Switching Speed
- Low Input/Output Leakage
- **Lead Free By Design/RoHS Compliant (Note 1)**
- **"Green" Device (Note 2)**
- **Qualified to AEC-Q 101 Standards for High Reliability**



TOP VIEW

SOT-323

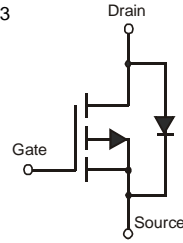

Internal Schematic

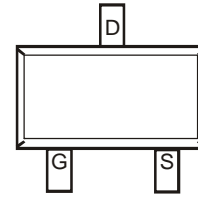

TOP VIEW

## Mechanical Data

- Case: SOT-323
- Case Material: Molded Plastic, "Green" Molding Compound. UL Flammability Classification Rating 94V-0
- Moisture Sensitivity: Level 1 per J-STD-020D
- Terminals Connections: See Diagram Below
- Terminals: Finish - Matte Tin annealed over Alloy 42 leadframe. Solderable per MIL-STD-202, Method 208
- Marking Information: See Page 3
- Ordering Information: See Page 3
- Weight: 0.006 grams (approximate)

## Maximum Ratings @ $T_A = 25^\circ C$ unless otherwise specified

Characteristic	Symbol	Value	Units
Drain-Source Voltage	$V_{DSS}$	-20	V
Gate-Source Voltage	$V_{GSS}$	$\pm 12$	V
Drain Current (Note 3)	$I_D$	$T_A = 25^\circ C$	-1.5
		$T_A = 70^\circ C$	-1.2
Pulsed Drain Current	$I_{DM}$	-10	A

## Thermal Characteristics

Characteristic	Symbol	Value	Units
Total Power Dissipation (Note 3)	$P_D$	350	mW
Thermal Resistance, Junction to Ambient	$R_{\theta JA}$	360	$^\circ C/W$
Operating and Storage Temperature Range	$T_J, T_{STG}$	-55 to +150	$^\circ C$

- Notes:
1. No purposefully added lead.
  2. Diodes Inc.'s "Green" policy can be found on our website at [http://www.diodes.com/products/lead\\_free/index.php](http://www.diodes.com/products/lead_free/index.php).
  3. Device mounted on 1in<sup>2</sup> FR-4 PCB with 2 oz. Copper.  $t \leq 10$  sec.

**Electrical Characteristics** @ $T_A = 25^\circ\text{C}$  unless otherwise specified

Characteristic	Symbol	Min	Typ	Max	Unit	Test Condition
<b>OFF CHARACTERISTICS (Note 4)</b>						
Drain-Source Breakdown Voltage	$BV_{DSS}$	-20	—	—	V	$V_{GS} = 0V, I_D = -250\mu A$
Zero Gate Voltage Drain Current	$I_{DSS}$	—	—	-1.0	$\mu A$	$V_{DS} = -20V, V_{GS} = 0V$
Gate-Source Leakage	$I_{GSS}$	—	—	$\pm 100$ $\pm 800$	nA	$V_{GS} = \pm 8V, V_{DS} = 0V$ $V_{GS} = \pm 12V, V_{DS} = 0V$
<b>ON CHARACTERISTICS (Note 4)</b>						
Gate Threshold Voltage	$V_{GS(th)}$	-0.4	-0.6	-0.9	V	$V_{DS} = V_{GS}, I_D = -250\mu A$
Static Drain-Source On-Resistance	$R_{DS(on)}$	—	75	100	m $\Omega$	$V_{GS} = -4.5V, I_D = -1.5A$
			90	120		$V_{GS} = -2.5V, I_D = -1.2A$
			120	160		$V_{GS} = -1.8V, I_D = -1A$
Forward Transconductance	$g_{FS}$	—	4	—	S	$V_{DS} = -10V, I_D = -1.5A$
Diode Forward Voltage (Note 4)	$V_{SD}$	—	—	-1.0	V	$V_{GS} = 0V, I_S = -1.0A$
<b>DYNAMIC CHARACTERISTICS</b>						
Input Capacitance	$C_{iss}$	—	627	—	pF	$V_{DS} = -10V, V_{GS} = 0V$ $f = 1.0MHz$
Output Capacitance	$C_{oss}$	—	64	—	pF	
Reverse Transfer Capacitance	$C_{rss}$	—	53	—	pF	

Notes: 4. Short duration pulse test used to minimize self-heating effect.

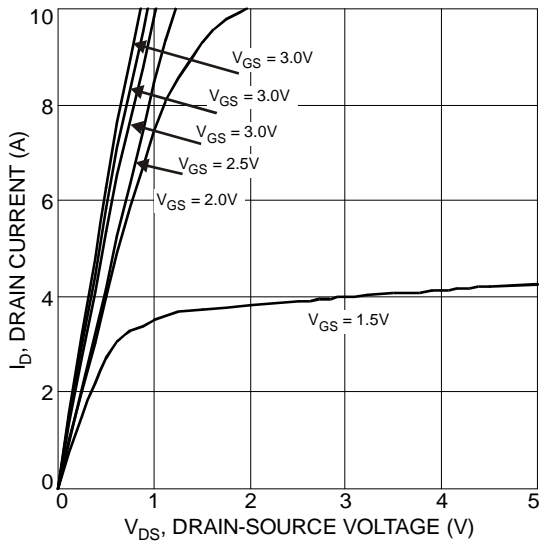

Fig. 1 Typical Output Characteristics

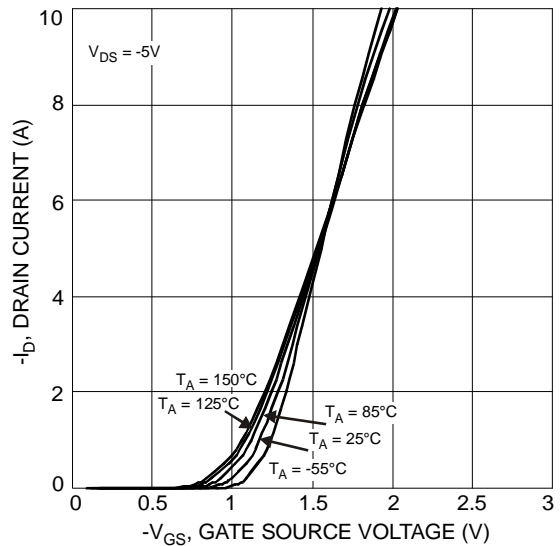

Fig. 2 Typical Transfer Characteristics

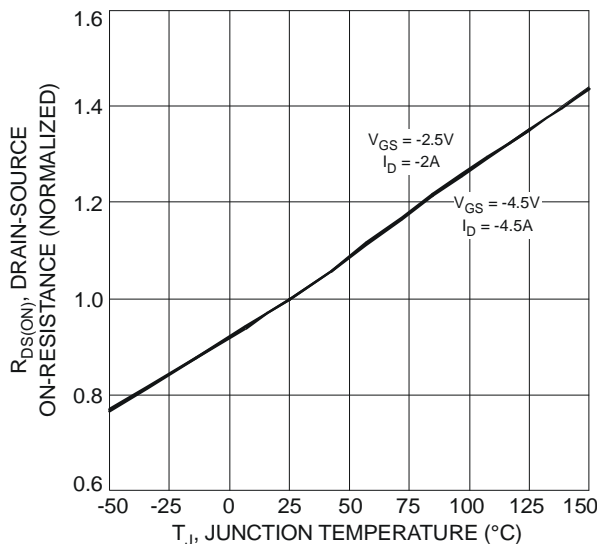

Fig. 3 On-Resistance Variation with Temperature

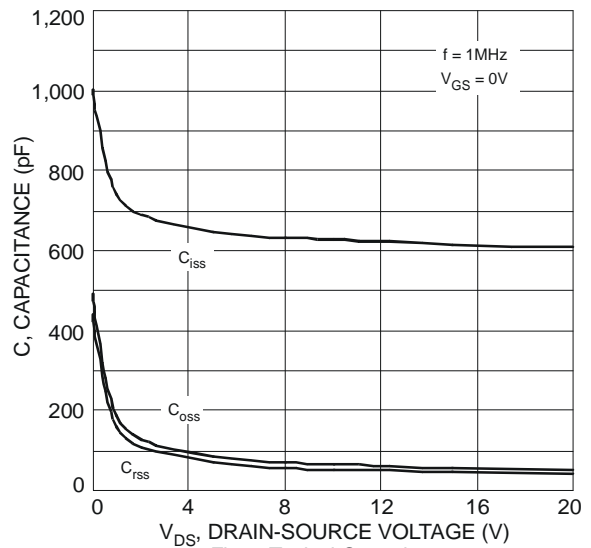

Fig. 4 Typical Capacitance

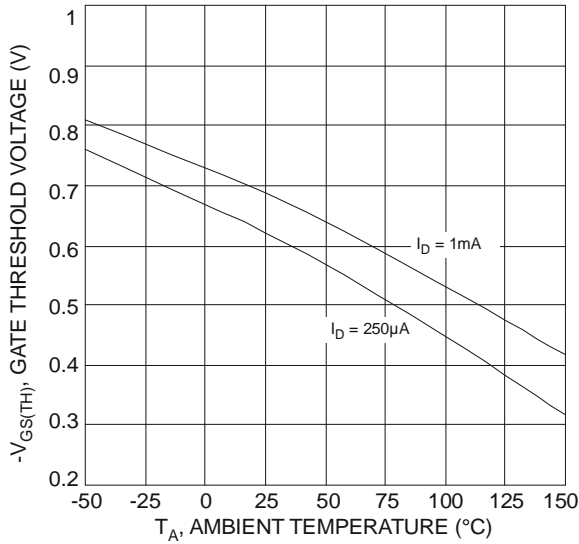

Fig. 5 Gate Threshold Variation vs. Ambient Temperature

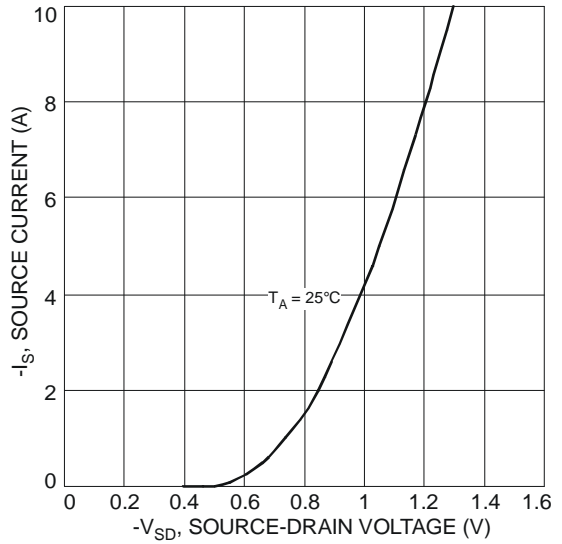

Fig. 6 Diode Forward Voltage vs. Current

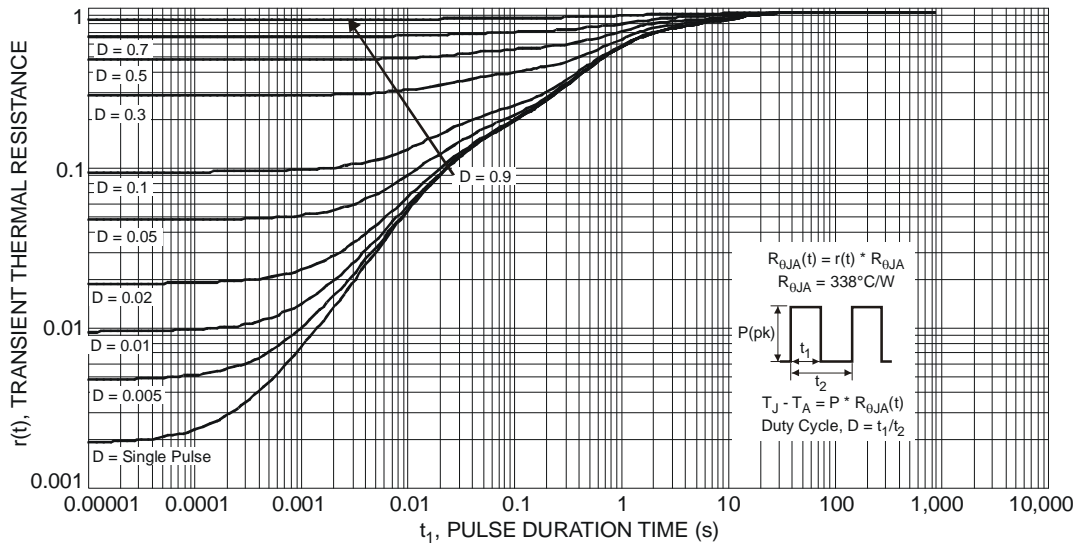

Fig. 7 Transient Thermal Response

**Ordering Information** (Note 5)

Part Number	Case	Packaging
DMP2160UW-7	SOT-323	3000/Tape & Reel

Notes: 5. For packaging details, go to our website at <http://www.diodes.com/datasheets/ap02007.pdf>.

**Marking Information**

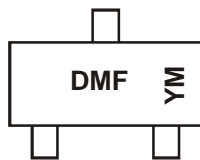

DMF = Marking Code  
YM = Date Code Marking  
Y = Year (ex: V = 2008)  
M = Month (ex: 9 = September)

Date Code Key

Year Code	2008	2009	2010	2011	2012	2013	2014	2015				
Code	V	W	X	Y	Z	A	B	C				
Month Code	Jan	Feb	Mar	Apr	May	Jun	Jul	Aug	Sep	Oct	Nov	Dec
Code	1	2	3	4	5	6	7	8	9	O	N	D

**Package Outline Dimensions**

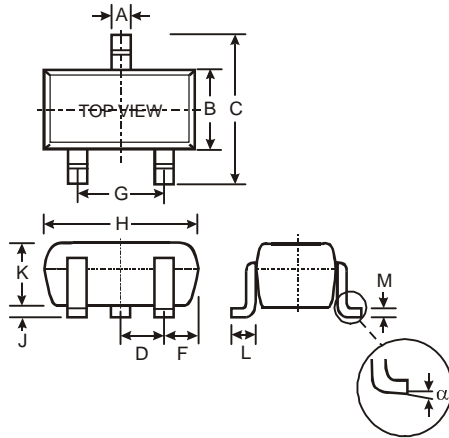

SOT-323			
Dim	Min	Max	Typ
A	0.25	0.40	0.30
B	1.15	1.35	1.30
C	2.00	2.20	2.10
D	-	-	0.65
F	0.30	0.40	0.425
G	1.20	1.40	1.30
H	1.80	2.20	2.15
J	0.0	0.10	0.05
K	0.90	1.00	1.00
L	0.25	0.40	0.30
M	0.10	0.18	0.11
α	0°	8°	-
All Dimensions in mm			

**Suggested Pad Layout**

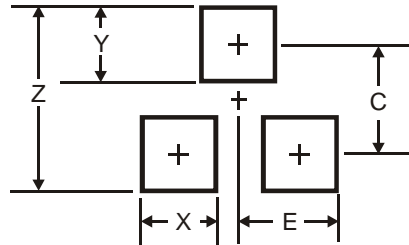

Dimensions	Value (in mm)
Z	2.8
X	0.7
Y	0.9
C	1.9
E	1.0

**IMPORTANT NOTICE**

Diodes Incorporated and its subsidiaries reserve the right to make modifications, enhancements, improvements, corrections or other changes without further notice to any product herein. Diodes Incorporated does not assume any liability arising out of the application or use of any product described herein; neither does it convey any license under its patent rights, nor the rights of others. The user of products in such applications shall assume all risks of such use and will agree to hold Diodes Incorporated and all the companies whose products are represented on our website, harmless against all damages.

**LIFE SUPPORT**

Diodes Incorporated products are not authorized for use as critical components in life support devices or systems without the expressed written approval of the President of Diodes Incorporated.