

**Features**

- Dual P-Channel MOSFET
- Low On-Resistance
  - 5.0Ω @ -4.5V
  - 7.0Ω @ -2.5V
  - 10Ω @ -1.8V
  - 15Ω @ -1.5V
- Very Low Gate Threshold Voltage  $V_{GS(TH)} < 1V$
- Low Input Capacitance
- Fast Switching Speed
- **Lead Free By Design/RoHS Compliant (Note 2)**
- **ESD Protected Gate**
- **"Green" Device (Note 3)**
- **Qualified to AEC-Q101 Standards for High Reliability**

**Mechanical Data**

- Case: SOT-963
- Case Material: Molded Plastic, "Green" Molding Compound. UL Flammability Classification Rating 94V-0
- Moisture Sensitivity: Level 1 per J-STD-020
- Terminal Connections: See Diagram
- Terminals: Finish - Matte Tin annealed over Copper lead frame. Solderable per MIL-STD-202, Method 208
- Marking Information: See Page 2
- Ordering Information: See Page 2
- Weight: 0.0027 grams (approximate)

SOT-963

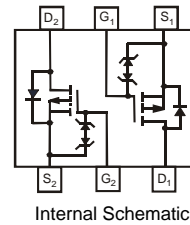

**Maximum Ratings** @ $T_A = 25^\circ C$  unless otherwise specified

Characteristic	Symbol	Value	Units
Drain-Source Voltage	$V_{DSS}$	-20	V
Gate-Source Voltage	$V_{GSS}$	$\pm 8$	V
Continuous Drain Current (Note 1)	$I_D$	@ $T_A = 25^\circ C$	-140
		@ $T_A = 85^\circ C$	-100
Pulsed Drain Current	$I_{DM}$	-600	mA

**Thermal Characteristics** @ $T_A = 25^\circ C$  unless otherwise specified

Characteristic	Symbol	Value	Units
Total Power Dissipation (Note 1)	$P_D$	330	mW
Thermal Resistance, Junction to Ambient, Note 1	$R_{\theta JA}$	377.16	$^\circ C/W$
Operating and Storage Temperature Range	$T_J, T_{STG}$	-55 to +150	$^\circ C$

- Notes:
1. Device mounted on 1"x1" FR-4 substrate PC board, with minimum recommended pad layout, single sided.
  2. No purposefully added lead.
  3. Diodes Inc.'s "Green" policy can be found on our website at [http://www.diodes.com/products/lead\\_free/index.php](http://www.diodes.com/products/lead_free/index.php).

**Electrical Characteristics** @T<sub>A</sub> = 25°C unless otherwise specified

Characteristic	Symbol	Min	Typ	Max	Unit	Test Condition
<b>OFF CHARACTERISTICS (Note 4)</b>						
Drain-Source Breakdown Voltage	BV <sub>DSS</sub>	-20	—	—	V	V <sub>GS</sub> = 0V, I <sub>D</sub> = -250mA
Zero Gate Voltage Drain Current	I <sub>DSS</sub>	—	—	-100	nA	V <sub>DS</sub> = -16V, V <sub>GS</sub> = 0V
		—	—	-50	nA	V <sub>DS</sub> = -5.0V, V <sub>GS</sub> = 0V
Gate-Source Leakage	I <sub>GSS</sub>	—	—	±100	nA	V <sub>GS</sub> = ±5.0V, V <sub>DS</sub> = 0V
<b>ON CHARACTERISTICS (Note 4)</b>						
Gate Threshold Voltage	V <sub>GS(th)</sub>	-0.5	—	-1.0	V	V <sub>DS</sub> = V <sub>GS</sub> , I <sub>D</sub> = -250μA
Static Drain-Source On-Resistance	R <sub>DS(on)</sub>	—	—	5.0	Ω	V <sub>GS</sub> = -4.5V, I <sub>D</sub> = -100mA
				7.0		V <sub>GS</sub> = -2.5V, I <sub>D</sub> = -50mA
				10		V <sub>GS</sub> = -1.8V, I <sub>D</sub> = -20mA
				15		V <sub>GS</sub> = -1.5V, I <sub>D</sub> = -10mA
Forward Transfer Admittance	Y <sub>fs</sub>	200	—	—	mS	V <sub>DS</sub> = -10V, I <sub>D</sub> = -0.2A
Diode Forward Voltage (Note 4)	V <sub>SD</sub>	-0.5	—	-1.2	V	V <sub>GS</sub> = 0V, I <sub>S</sub> = -115mA
<b>DYNAMIC CHARACTERISTICS (Note 5)</b>						
Input Capacitance	C <sub>iss</sub>	—	13.72	175	pF	V <sub>DS</sub> = -15V, V <sub>GS</sub> = 0V f = 1.0MHz
Output Capacitance	C <sub>oss</sub>	—	4.01	30	pF	
Reverse Transfer Capacitance	C <sub>rss</sub>	—	2.34	20	pF	
<b>SWITCHING CHARACTERISTICS (Note 5)</b>						
Turn-On Delay Time	t <sub>d(on)</sub>	—	20	—	ms	V <sub>GS</sub> = -4.5V, V <sub>DD</sub> = -15V I <sub>D</sub> = -180mA, R <sub>G</sub> = 2.0Ω
Rise Time	t <sub>r</sub>	—	37	—		
Turn-Off Delay Time	t <sub>d(off)</sub>	—	112	—		
Fall Time	t <sub>f</sub>	—	97	—		

Notes: 4. Short duration pulse test used to minimize self-heating effect.  
5. Guaranteed by design. Not subject to production testing.

**Typical Characteristics**

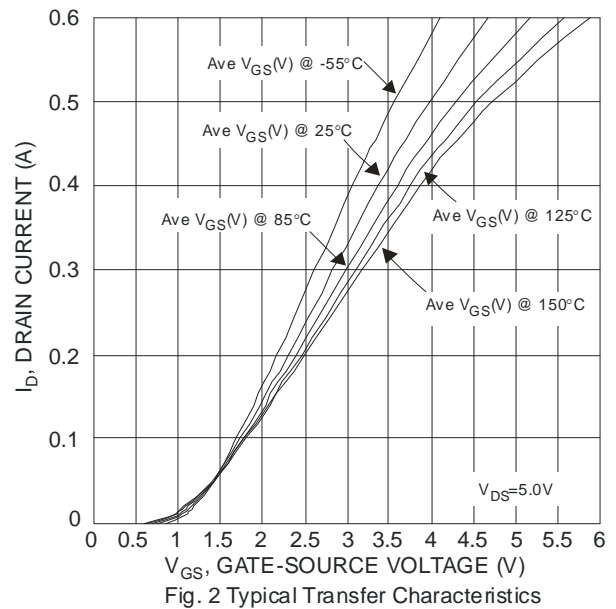
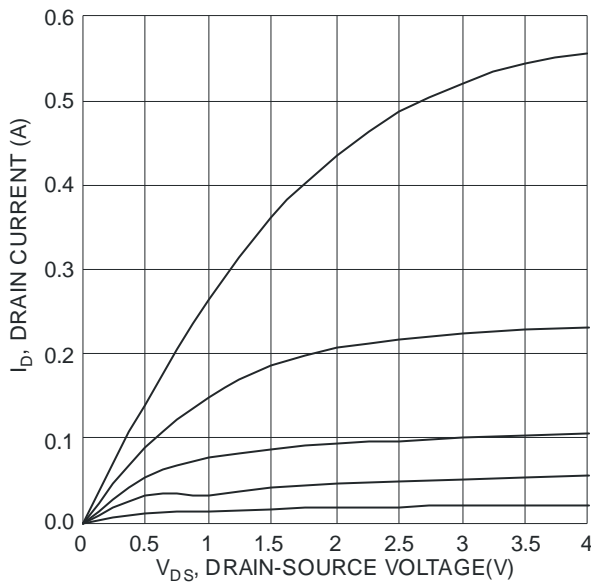

**Typical Characteristics**

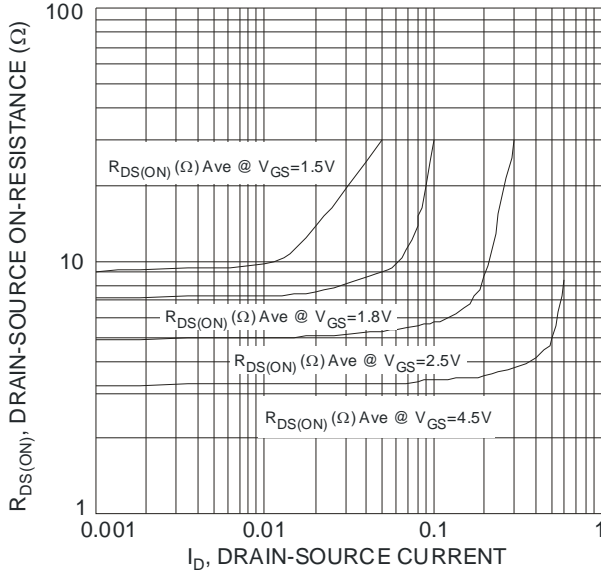

Fig. 3 Typical On-Resistance vs. Drain Current and Gate Voltage

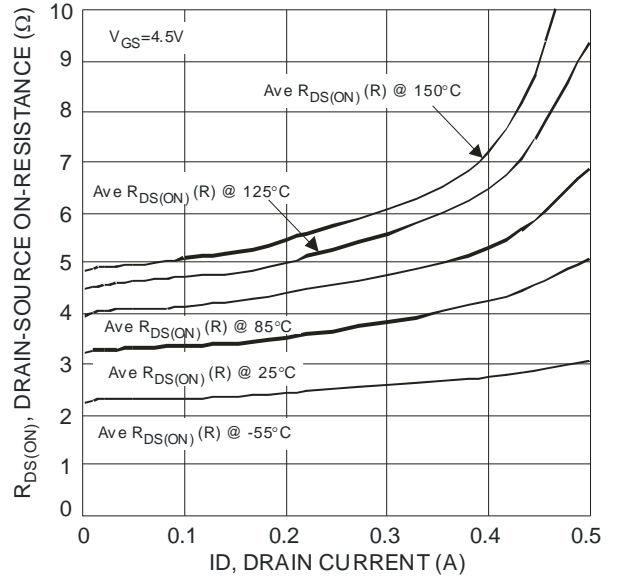

Fig. 4 Typical On-Resistance vs. Drain Current and Temperature

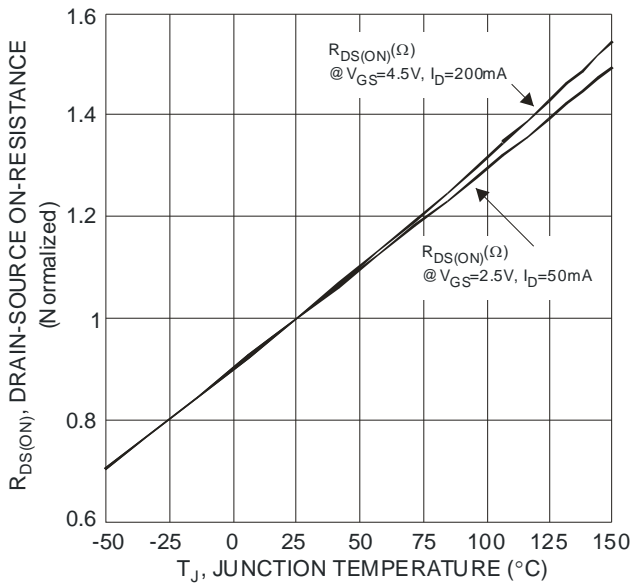

Fig. 5 On-Resistance Variation with Temperature

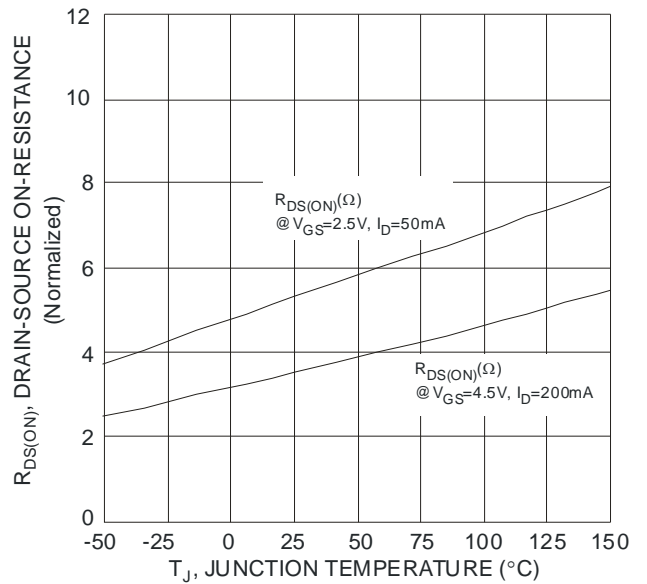

Fig. 6 On-Resistance vs. Temperature

**Typical Characteristics**

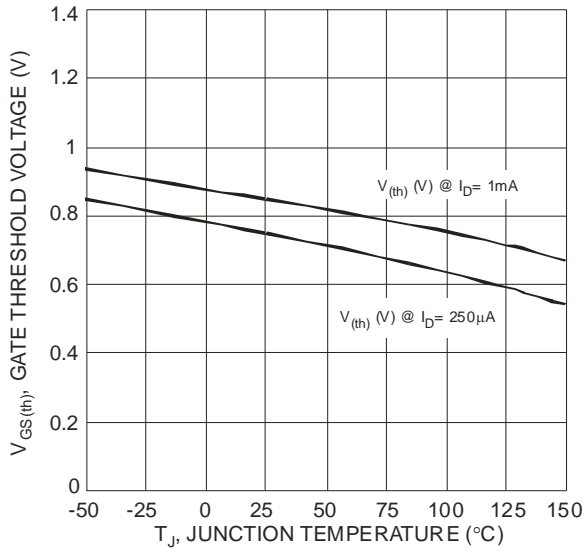

Fig. 7 Gate Threshold Variation vs. Ambient Temperature

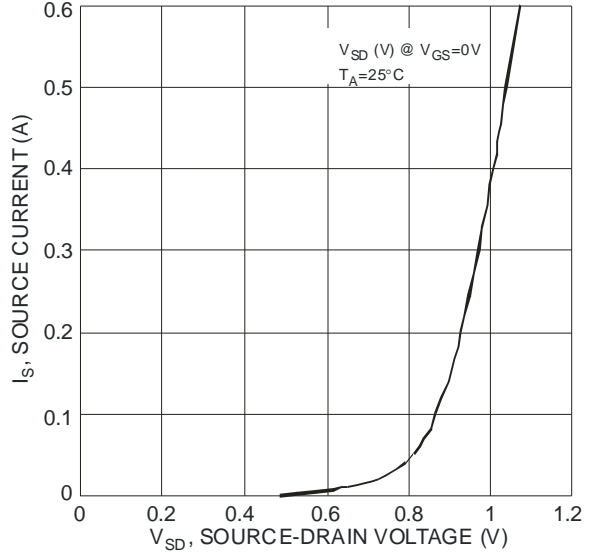

Fig. 8 Diode Forward Voltage vs. Current

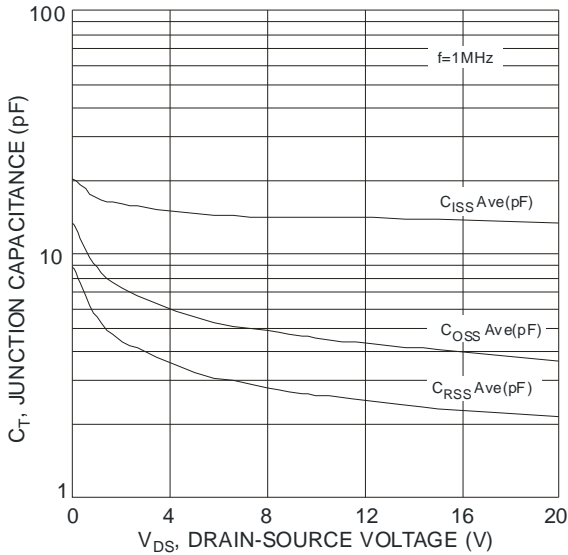

Fig. 9 Typical Junction Capacitance

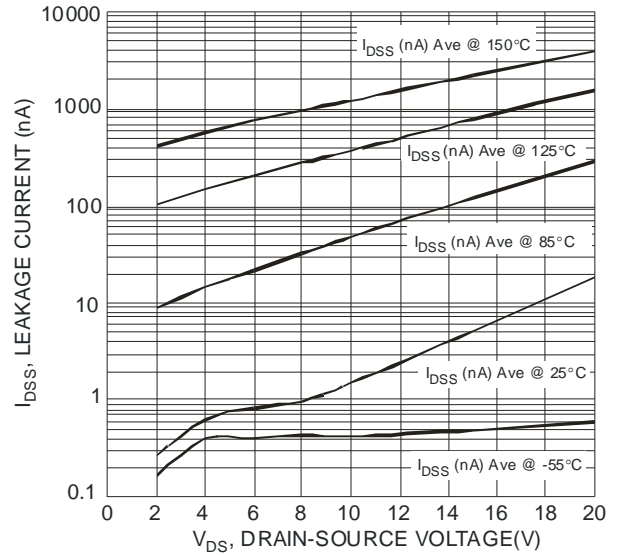

Fig. 10 Typical Drain-Source Leakage Current vs. Voltage

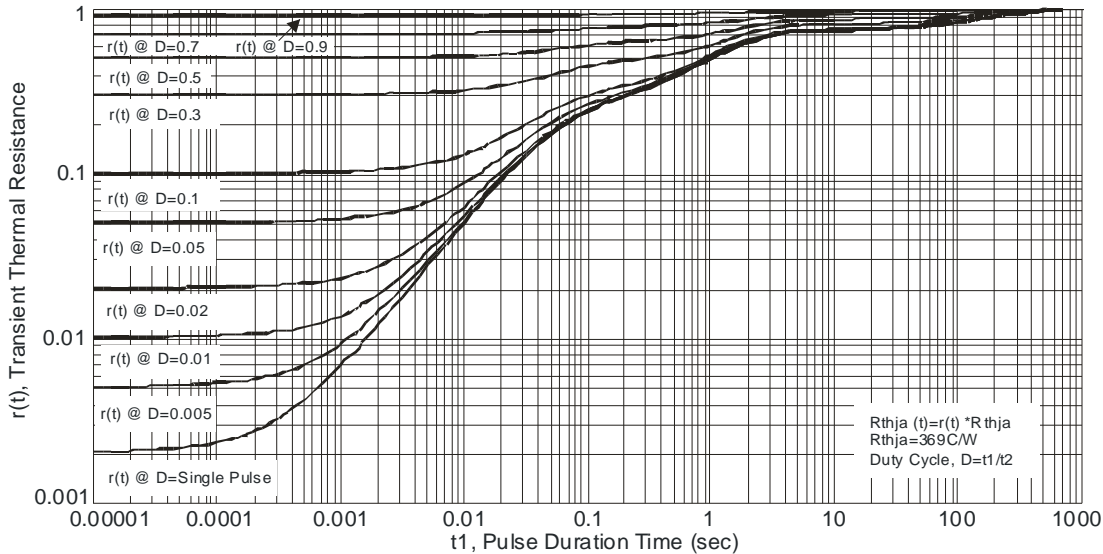

Fig. 11 Transient Thermal Resistance

**Ordering Information** (Note 6)

Part Number	Case	Packaging
DMP210DUDJ-7	SOT-963	10,000/Tape & Reel

Notes: 6. For packaging details, go to our website at <http://www.diodes.com/datasheets/ap02007.pdf>.

**Marking Information** (Note 7)

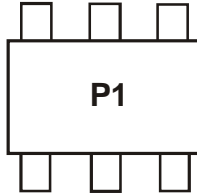

P1 = Product Type Marking Code

Notes: 7. Package is non-polarized. Parts may be on reel in orientation illustrated, 180° rotated, or mixed (both ways).

**Package Outline Dimensions**

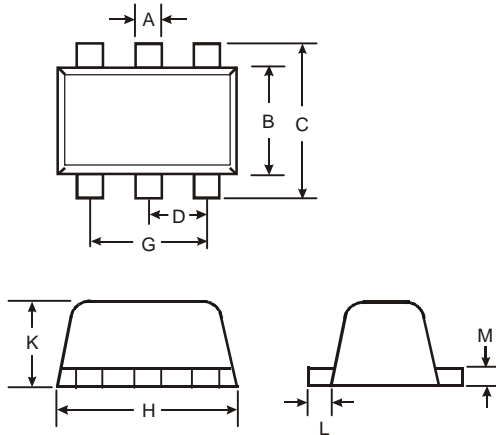

SOT-963			
Dim	Min	Max	Typ
A	0.10	0.20	0.15
B	0.95	1.05	1.00
C	0.95	1.05	1.00
D		0.35	
G		0.70	
H	0.95	1.05	1.00
K	0.40	0.50	0.45
L	0.05	0.15	0.10
M	0.05	0.15	0.10
All Dimensions in mm			

**Suggested Pad Layout**

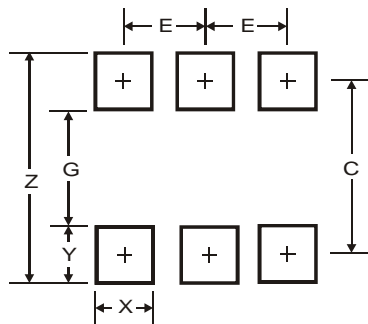

Dimensions	Value (in mm)
Z	1.10
G	0.70
X	0.20
Y	0.20
C	0.90
E	0.35

**IMPORTANT NOTICE**

DIODES INCORPORATED MAKES NO WARRANTY OF ANY KIND, EXPRESS OR IMPLIED, WITH REGARDS TO THIS DOCUMENT, INCLUDING, BUT NOT LIMITED TO, THE IMPLIED WARRANTIES OF MERCHANTABILITY AND FITNESS FOR A PARTICULAR PURPOSE (AND THEIR EQUIVALENTS UNDER THE LAWS OF ANY JURISDICTION).

Diodes Incorporated and its subsidiaries reserve the right to make modifications, enhancements, improvements, corrections or other changes without further notice to this document and any product described herein. Diodes Incorporated does not assume any liability arising out of the application or use of this document or any product described herein; neither does Diodes Incorporated convey any license under its patent or trademark rights, nor the rights of others. Any Customer or user of this document or products described herein in such applications shall assume all risks of such use and will agree to hold Diodes Incorporated and all the companies whose products are represented on Diodes Incorporated website, harmless against all damages.

Diodes Incorporated does not warrant or accept any liability whatsoever in respect of any products purchased through unauthorized sales channel. Should Customers purchase or use Diodes Incorporated products for any unintended or unauthorized application, Customers shall indemnify and hold Diodes Incorporated and its representatives harmless against all claims, damages, expenses, and attorney fees arising out of, directly or indirectly, any claim of personal injury or death associated with such unintended or unauthorized application.

Products described herein may be covered by one or more United States, international or foreign patents pending. Product names and markings noted herein may also be covered by one or more United States, international or foreign trademarks.

**LIFE SUPPORT**

Diodes Incorporated products are specifically not authorized for use as critical components in life support devices or systems without the express written approval of the Chief Executive Officer of Diodes Incorporated. As used herein:

A. Life support devices or systems are devices or systems which:

1. are intended to implant into the body, or
2. support or sustain life and whose failure to perform when properly used in accordance with instructions for use provided in the labeling can be reasonably expected to result in significant injury to the user.

B. A critical component is any component in a life support device or system whose failure to perform can be reasonably expected to cause the failure of the life support device or to affect its safety or effectiveness.

Customers represent that they have all necessary expertise in the safety and regulatory ramifications of their life support devices or systems, and acknowledge and agree that they are solely responsible for all legal, regulatory and safety-related requirements concerning their products and any use of Diodes Incorporated products in such safety-critical, life support devices or systems, notwithstanding any devices- or systems-related information or support that may be provided by Diodes Incorporated. Further, Customers must fully indemnify Diodes Incorporated and its representatives against any damages arising out of the use of Diodes Incorporated products in such safety-critical, life support devices or systems.

Copyright © 2010, Diodes Incorporated

[www.diodes.com](http://www.diodes.com)