

DATA SHEET

DD02-92, DD02-92LF: Directional Detector

Features

- Frequency coverage: 650 MHz to 3.0 GHz
- Typical insertion loss < 0.2 dB to 2.3 GHz
- Typical directivity > 23 dB
- Small outline SC-88 (6 Lead SC-70)
- Built-in temperature compensating diode
- Low cost for high-volume handset applications
- Available lead (Pb)-free MSL-2 @ 250 °C per JEDEC J-STD-020



Description

The DD02-92 directional detector is an alternative to the DD01-92 with improved insertion loss and directivity with slightly lower sensitivity. It is designed for handset power monitor applications from 800 MHz to 3 GHz. It is packaged in the small footprint, SC-88 (6 lead SC-70) package. The DD02-92 incorporates a directional coupler and two GaAs Schottky diodes on a monolithic GaAs chip. By applying forward DC bias to both Schottky diodes, the DD02-92 may be conveniently temperature compensated. The DD02-92 is characterized from 500 MHz to 3 GHz and generates a detected signal at 1.8 GHz of approximately 190 mV at 10 mW input power. Each Schottky diode is forward biased to approximately 5 μ A.

Pin Out

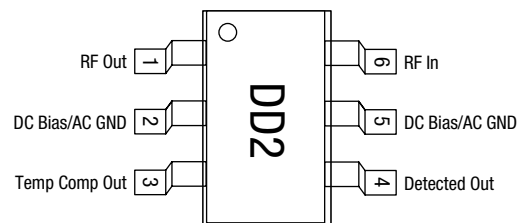

NEW Skyworks offers lead (Pb)-free “environmentally friendly” packaging that is RoHS compliant (European Parliament for the Restriction of Hazardous Substances).



Electrical Specifications at 25 °C

| Parameter | Frequency | Min. | Typ. | Max. | Unit |
|--|--------------|------|------|------|----------|
| Detected output voltage @ 10 dBm | 0.8–1.2 GHz | 60 | 80 | 105 | mV |
| | 1.8–2.0 GHz | 130 | 160 | 190 | mV |
| Insertion loss | 0.8–1.2 GHz | | 0.10 | 0.20 | dB |
| | 1.8–2.0 GHz | | 0.20 | 0.30 | dB |
| Input return loss | 0.8–1.2 GHz | | 30 | 22 | dB |
| | 1.8–2.0 GHz | | 25 | 20 | dB |
| Output return loss | 0.8–1.2 GHz | | 30 | 22 | dB |
| | 1.8–2.0 GHz | | 25 | 20 | dB |
| Directivity | 0.8–1.2 GHz | 17 | 20 | | dB |
| | 1.8–2.0 GHz | 16 | 13 | | dB |
| Schottky noise voltage (1 MHz bandwidth) | RF power off | | 200 | | μ V |
| Schottky diode DC voltage | RF power off | | 510 | | mV |
| DC offset voltage | RF power off | -5 | 0 | +5 | mV |
| Video resistance | RF power off | | 7500 | | Ω |

Conditions: 10 dBm input power, 1 V applied to Pin 2 and 5 (See test circuit).
All data was taken with $R_{LOAD} = 100\text{ k}\Omega$.

Detected output voltage is the difference between V_{REF} and V_{DET} . A digital voltmeter was used as a differential amplifier.

Typical Performance Data

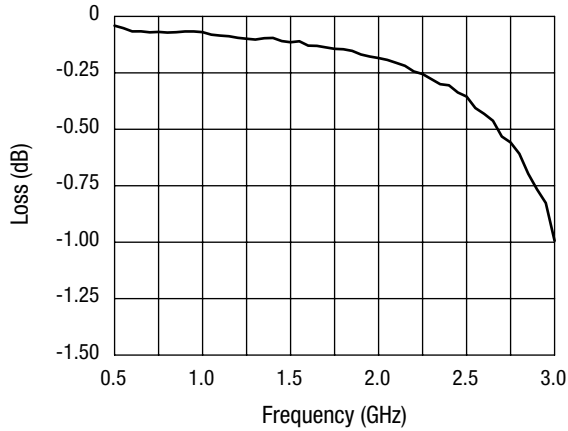

Insertion Loss vs. Frequency

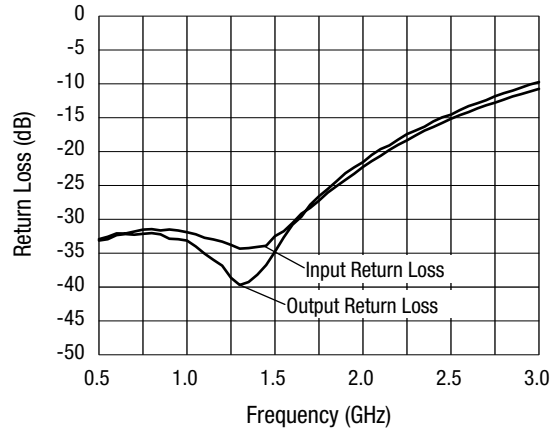

Return Loss vs. Frequency

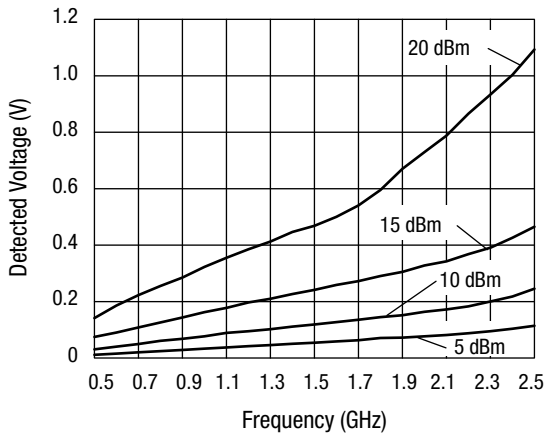

Differential Detected Voltage vs. Frequency and Power

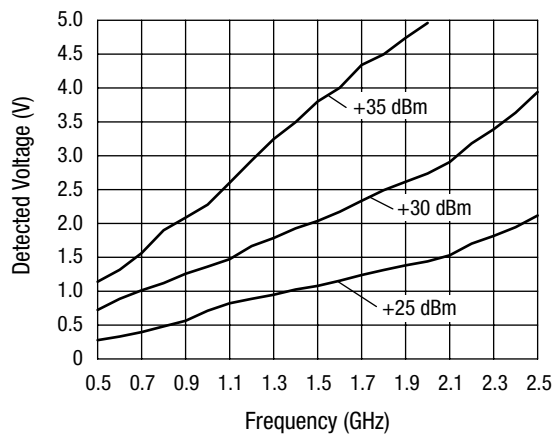

Differential Detected Voltage vs. Frequency & Power

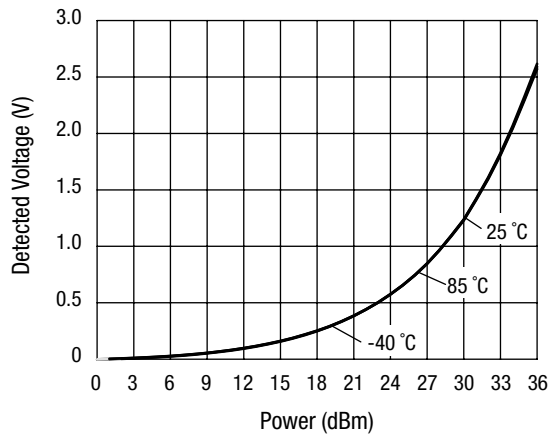

Differential Detected Voltage vs. Power and Temperature @ 900 MHz

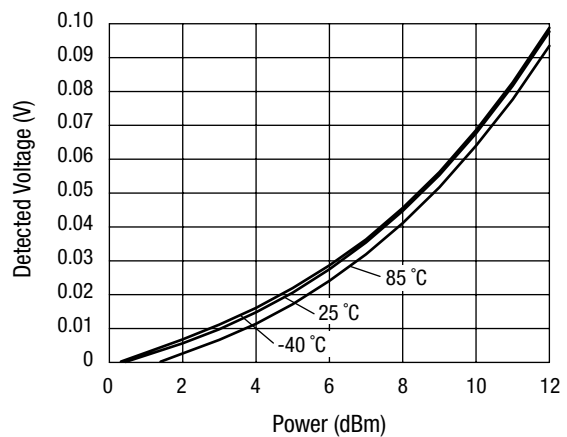

Differential Detected Voltage vs. Power and Temperature @ 900 MHz

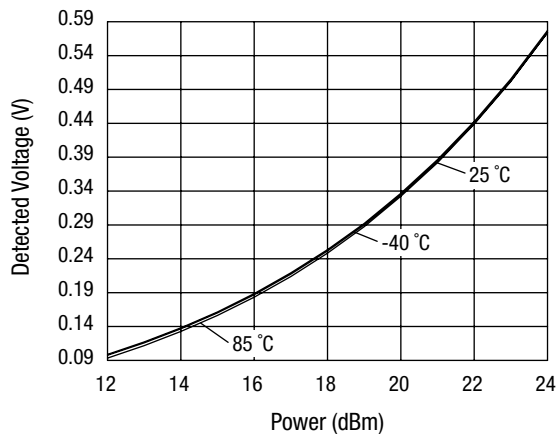

Differential Detected Voltage vs. Power and Temperature @ 900 MHz

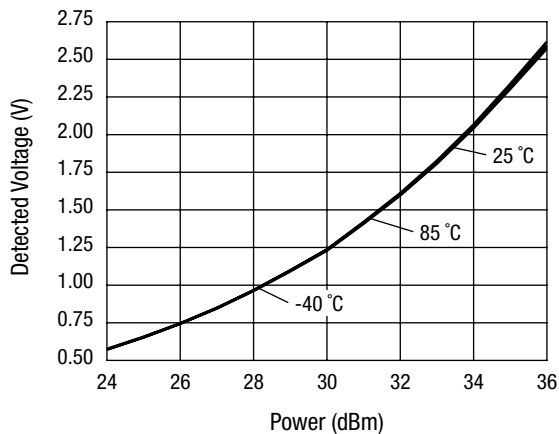

Differential Detected Voltage vs. Power and Temperature @ 900 MHz

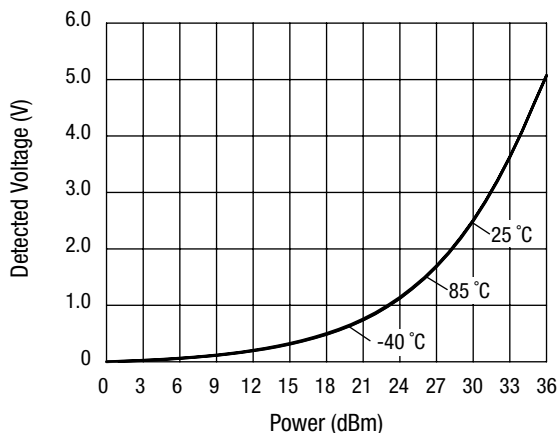

Differential Detected Voltage vs. Power and Temperature @ 1900 MHz

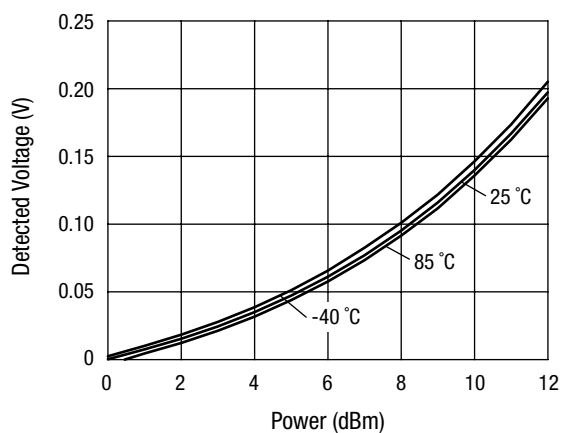

Differential Detected Voltage vs. Power and Temperature @ 1900 MHz

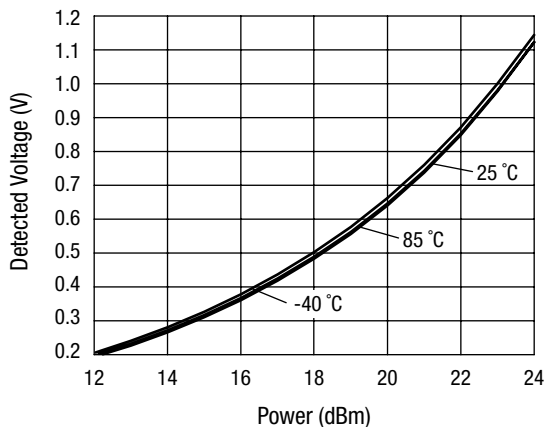

Differential Detected Voltage vs. Power and Temperature @ 1900 MHz

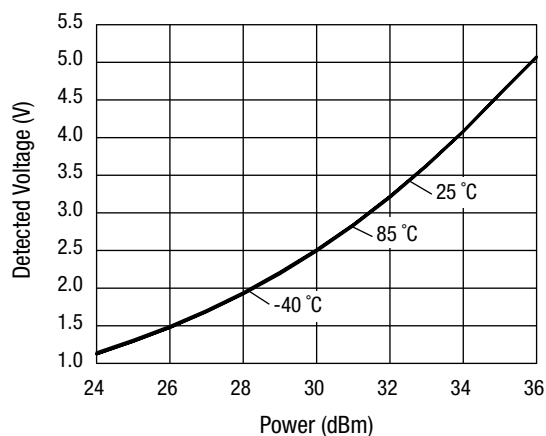

Differential Detected Voltage vs. Power and Temperature @ 1900 MHz

SC-88 (6 Lead SC-70)

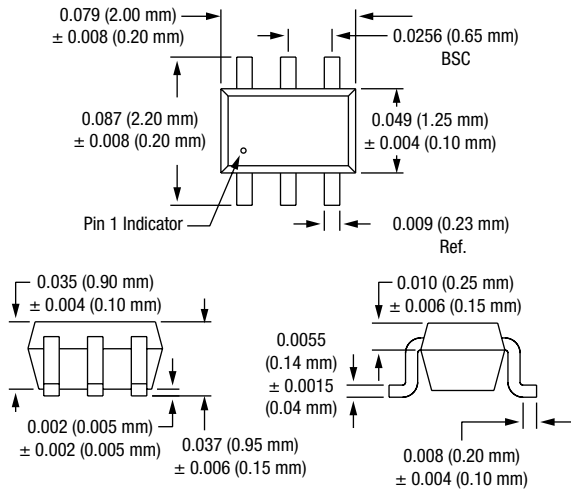

Evaluation Board Layout

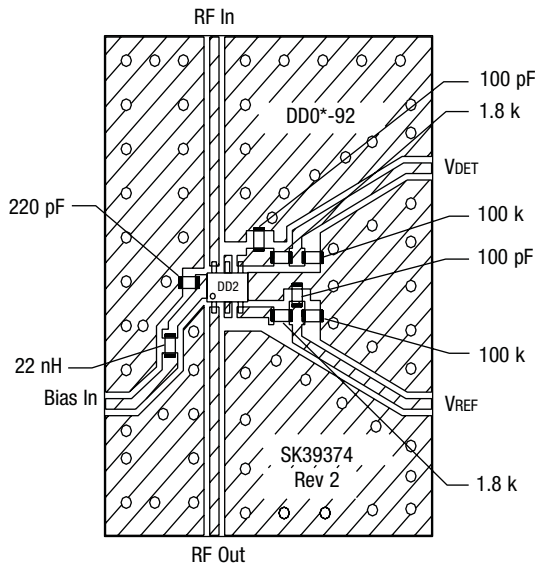

Absolute Maximum Ratings

| Characteristic | Value |
|---|----------------------------------|
| Incident power (CW) @ SWR = 2.0 max. | 4 W @ < 1 GHz 2 W @ 1–2.5 GHz |
| DC bias current | 10 mA |
| Operating temperature | -40 to +85 °C |
| Storage temperature | -65 to +150 °C |

Performance is guaranteed only under the conditions listed in the specifications table and is not guaranteed under the full range(s) described by the Absolute Maximum specifications. Exceeding any of the absolute maximum/minimum specifications may result in permanent damage to the device and will void the warranty.

CAUTION: Although this device is designed to be as robust as possible, Electrostatic Discharge (ESD) can damage this device. This device must be protected at all times from ESD. Static charges may easily produce potentials of several kilovolts on the human body or equipment, which can discharge without detection. Industry-standard ESD precautions must be employed at all times.

Test Circuit

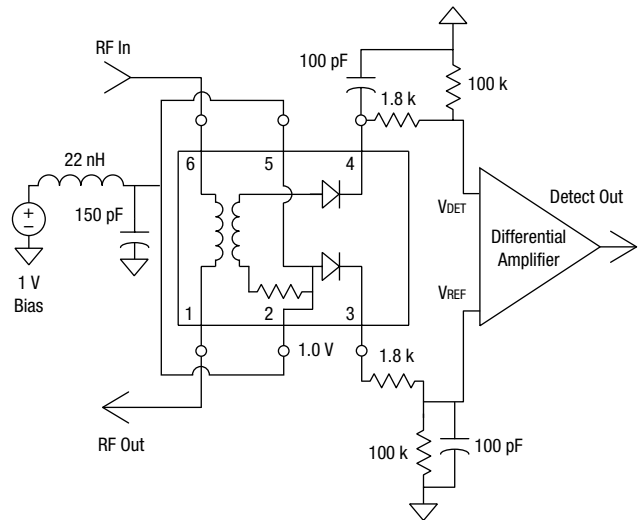

Copyright © 2002, 2003, 2004 Skyworks Solutions, Inc. All Rights Reserved.

Information in this document is provided in connection with Skyworks Solutions, Inc. ("Skyworks") products. These materials are provided by Skyworks as a service to its customers and may be used for informational purposes only by the customer. Skyworks assumes no responsibility for errors or omissions in these materials. Skyworks may make changes to its documentation, products, specifications and product descriptions at any time, without notice. Skyworks makes no commitment to update the information and shall have no responsibility whatsoever for conflicts, incompatibilities, or other difficulties arising from future changes to its documentation, products, specifications and product descriptions.

No license, express or implied, by estoppel or otherwise, to any intellectual property rights is granted by or under this document. Except as may be provided in Skyworks' Terms and Conditions of Sale for such products, Skyworks assumes no liability whatsoever in association with its documentation, products, specifications and product descriptions.

THESE MATERIALS ARE PROVIDED "AS IS" WITHOUT WARRANTY OF ANY KIND, EITHER EXPRESS OR IMPLIED OR OTHERWISE, RELATING TO SALE AND/OR USE OF SKYWORKS PRODUCTS INCLUDING WARRANTIES RELATING TO FITNESS FOR A PARTICULAR PURPOSE, MERCHANTABILITY, PERFORMANCE, QUALITY OR NON-INFRINGEMENT OF ANY PATENT, COPYRIGHT OR OTHER INTELLECTUAL PROPERTY RIGHT. SKYWORKS FURTHER DOES NOT WARRANT THE ACCURACY OR COMPLETENESS OF THE INFORMATION, TEXT, GRAPHICS OR OTHER ITEMS CONTAINED WITHIN THESE MATERIALS. SKYWORKS SHALL NOT BE LIABLE FOR ANY DAMAGES, INCLUDING SPECIAL, INDIRECT, INCIDENTAL, OR CONSEQUENTIAL DAMAGES, INCLUDING WITHOUT LIMITATION, LOST REVENUES OR LOST PROFITS THAT MAY RESULT FROM THE USE OF THESE MATERIALS WHETHER OR NOT THE RECIPIENT OF MATERIALS HAS BEEN ADVISED OF THE POSSIBILITY OF SUCH DAMAGE.

Skyworks products are not intended for use in medical, lifesaving or life-sustaining applications. Skyworks' customers using or selling Skyworks products for use in such applications do so at their own risk and agree to fully indemnify Skyworks for any damages resulting from such improper use or sale.

The following are trademarks of Skyworks Solutions, Inc.: Skyworks™, the Skyworks logo, and Breakthrough Simplicity™. Product names or services listed in this publication are for identification purposes only, and may be trademarks of Skyworks or other third parties. Third-party brands and names are the property of their respective owners. Additional information, posted at www.skyworkssolutions.com, is incorporated by reference.