

2Gb DDR2 SDRAM

H5PS2G43MFP

H5PS2G83MFP

Revision Details

Rev.	History	Draft Date
0.1	Initial data sheet released	Jun. 2007
0.2	Corrected Typos & Ball out	Aug. 2007
0.3	Adjusted IDD Values	May. 2008

Contents

1. Description

1.1 Device Features and Ordering Information

1.1.1 Key Features

1.1.2 Ordering Information

1.1.3 Operating Frequency

1.2 Pin configuration

1.3 Pin Description

2. Maximum DC ratings

2.1 Absolute Maximum DC Ratings

2.2 Operating Temperature Condition

3. AC & DC Operating Conditions

3.1 DC Operating Conditions

3.1.1 Recommended DC Operating Conditions(SSTL_1.8)

3.1.2 ODT DC Electrical Characteristics

3.2 DC & AC Logic Input Levels

3.2.1 Input DC Logic Level

3.2.2 Input AC Logic Level

3.2.3 AC Input Test Conditions

3.2.4 Differential Input AC Logic Level

3.2.5 Differential AC Output Parameters

3.3 Output Buffer Levels

3.3.1 Output AC Test Conditions

3.3.2 Output DC Current Drive

3.3.3 OCD default characteristics

3.4 IDD Specifications & Measurement Conditions

3.5 Input/Output Capacitance

4. AC Timing Specifications

5. Package Dimensions

1. Description

1.1 Device Features & Ordering Information

1.1.1 Key Features

- VDD = 1.8 +/- 0.1V
- VDDQ = 1.8 +/- 0.1V
- All inputs and outputs are compatible with SSTL_18 interface
- 8 banks
- Fully differential clock inputs (CK, /CK) operation
- Double data rate interface
- Source synchronous-data transaction aligned to bidirectional data strobe (DQS, $\overline{\text{DQS}}$)
- Differential Data Strobe ($\overline{\text{DQS}}$, $\overline{\text{DQS}}$)
- Data outputs on DQS, $\overline{\text{DQS}}$ edges when read (edged DQ)
- Data inputs on DQS centers when write(centered DQ)
- On chip DLL align DQ, DQS and $\overline{\text{DQS}}$ transition with CK transition
- DM mask write data-in at the both rising and falling edges of the data strobe
- All addresses and control inputs except data, data strobes and data masks latched on the rising edges of the clock
- Programmable CAS latency 3, 4, 5 and 6 supported
- Programmable additive latency 0, 1, 2, 3, 4 and 5 supported
- Programmable burst length 4/8 with both nibble sequential and interleave mode
- Internal eight bank operations with single pulsed RAS
- Auto refresh and self refresh supported
- tRAS lockout supported
- 8K refresh cycles /64ms
- JEDEC standard 60ball FBGA(x4/x8)
- Full strength driver option controlled by EMR
- On Die Termination supported
- Off Chip Driver Impedance Adjustment supported
- Read Data Strobe supported (x8 only)
- Self-Refresh High Temperature Entry

Ordering Information

Part No.	Configuration	Package
H5PS2G43MFP-XX*	512Mx4	60 Ball
H5PS2G83MFP-XX*	256Mx8	

Note:

-XX* is the speed bin, refer to the Operating Frequency table for complete part number.
Hynix lead-free products are compliant to RoHS.

Operating Frequency

Grade	tCK(ns)	CL	tRCD	tRP	Unit
E3	5	3	3	3	CIK
C4	3.75	4	4	4	CIK
Y5	3	5	5	5	CIK
S6	2.5	6	6	6	CIK
S5	2.5	5	5	5	CIK

1.2 Pin Configuration & Address Table

512Mx4 DDR2 Pin Configuration (Top view: see balls through package)

1	2	3		7	8	9
VDD	NC	VSS	A	VSSQ	$\overline{\text{DQS}}$	VDDQ
NC	VSSQ	DM	B	DQS	VSSQ	NC
VDDQ	DQ1	VDDQ	C	VDDQ	DQ0	VDDQ
NC	VSSQ	DQ3	D	DQ2	VSSQ	NC
VDDL	VREF	VSS	E	VSSDL	CK	VDD
	CKE	$\overline{\text{WE}}$	F	$\overline{\text{RAS}}$	$\overline{\text{CK}}$	ODT
BA2	BA0	BA1	G	$\overline{\text{CAS}}$	$\overline{\text{CS}}$	
	A10	A1	H	A2	A0	VDD
VSS	A3	A5	J	A6	A4	
	A7	A9	K	A11	A8	VSS
VDD	A12	A14	L	NC	A13	

ROW AND COLUMN ADDRESS TABLE

ITEMS	512Mx4
# of Bank	8
Bank Address	BA0, BA1, BA2
Auto Precharge Flag	A10/AP
Row Address	A0 - A14
Column Address	A0-A9, A11
Page size	1 KB

256Mx8 DDR2 PIN CONFIGURATION(Top view: see balls through package)

	1	2	3		7	8	9
	VDD	NU/RDQS	VSS	A	VSSQ	DQS	VDDQ
	DQ6	VSSQ	DM/RDQS	B	DQS	VSSQ	DQ7
	VDDQ	DQ1	VDDQ	C	VDDQ	DQ0	VDDQ
	DQ4	VSSQ	DQ3	D	DQ2	VSSQ	DQ5
	VDDL	VREF	VSS	E	VSSDL	CK	VDD
		CKE	WE	F	RAS	CK	ODT
	BA2	BA0	BA1	G	CAS	CS	
		A10	A1	H	A2	A0	VDD
	VSS	A3	A5	J	A6	A4	
		A7	A9	K	A11	A8	VSS
	VDD	A12	A14	L	NC	A13	

ROW AND COLUMN ADDRESS TABLE

ITEMS	256Mx8
# of Bank	8
Bank Address	BA0, BA1, BA2
Auto Precharge Flag	A10/AP
Row Address	A0 - A14
Column Address	A0-A9
Page size	1 KB

1.3 PIN DESCRIPTION

PIN	TYPE	DESCRIPTION
CK, $\overline{\text{CK}}$	Input	Clock: CK and $\overline{\text{CK}}$ are differential clock inputs. All address and control input signals are sampled on the crossing of the positive edge of CK and negative edge of $\overline{\text{CK}}$. Output (read) data is referenced to the crossings of CK and $\overline{\text{CK}}$ (both directions of crossing).
CKE	Input	Clock Enable: CKE HIGH activates, and CKE LOW deactivates internal clock signals, and device input buffers and output drivers. Taking CKE LOW provides PRECHARGE POWER DOWN and SELF REFRESH operation (all banks idle), or ACTIVE POWER DOWN (row ACTIVE in any bank). CKE is synchronous for POWER DOWN entry and exit, and for SELF REFRESH entry. CKE is asynchronous for SELF REFRESH exit. After V_{REF} has become stable during the power on and initialization sequence, it must be maintained for proper operation of the CKE receiver. For proper self-refresh entry and exit, V_{REF} must be maintained to this input. CKE must be maintained HIGH throughout READ and WRITE accesses. Input buffers, excluding CK, $\overline{\text{CK}}$ and CKE are disabled during POWER DOWN. Input buffers, excluding CKE are disabled during SELF REFRESH.
$\overline{\text{CS}}$	Input	Chip Select : All commands are masked when $\overline{\text{CS}}$ is registered HIGH. $\overline{\text{CS}}$ provides for external bank selection on systems with multiple banks. $\overline{\text{CS}}$ is considered part of the command code.
ODT	Input	On Die Termination Control : ODT(registered HIGH) enables on die termination resistance internal to the DDR2 SDRAM. When enabled, ODT is only applied to DQ, DQS, $\overline{\text{DQS}}$, RDQS, $\overline{\text{RDQS}}$, and DM signal for x4,x8 configurations. For x16 configuration ODT is applied to each DQ, UDQS/ $\overline{\text{UDQS}}$, LDQS/ $\overline{\text{LDQS}}$, UDM and LDM signal. The ODT pin will be ignored if the Extended Mode Register(EMR(1)) is programmed to disable ODT.
RAS, CAS, WE	Input	Command Inputs : RAS, CAS and WE (along with CS) define the command being entered.
DM (LDM, UDM)	Input	Input Data Mask : DM is an input mask signal for write data. Input Data is masked when DM is sampled High coincident with that input data during a WRITE access. DM is sampled on both edges of DQS, Although DM pins are input only, the DM loading matches the DQ and DQS loading. For x8 device, the function of DM or RDQS/ $\overline{\text{RDQS}}$ is enabled by EMR command to EMR(1).
BA0 - BA2	Input	Bank Address Inputs : BA0 - BA2 define to which bank an ACTIVE, Read, Write or PRECHARGE command is being applied(For 256Mb and 512Mb, BA2 is not applied). Bank address also determines if one of the mode register or extended mode register is to be accessed during a MR or EMR command cycle.
A0 -A15	Input	Address Inputs : Provide the row address for ACTIVE commands, and the column address and AUTO PRECHARGE bit for READ/WRITE commands to select one location out of the memory array in the respective bank. A10 is sampled during a precharge command to determine whether the PRECHARGE applies to one bank (A10 LOW) or all banks (A10 HIGH). If only one bank is to be precharged, the bank is selected by BA0-BA2. The address inputs also provide the op code during MRS or EMRS commands.
DQ	Input/Output	Data input / output : Bi-directional data bus
DQS, $\overline{\text{DQS}}$ (UDQS), $\overline{\text{UDQS}}$ (LDQS), $\overline{\text{LDQS}}$ (RDQS), $\overline{\text{RDQS}}$	Input/Output	<p>Data Strobe : Output with read data, input with write data. Edge aligned with read data, centered in write data. For the x16, LDQS correspond to the data on DQ0~DQ7; UDQS corresponds to the data on DQ8~DQ15. For the x8, an RDQS option using DM pin can be enabled via the EMR(1) to simplify read timing. The data strobes DQS, LDQS, UDQS, and RDQS may be used in single ended mode or paired with optional complementary signals $\overline{\text{DQS}}$, $\overline{\text{LDQS}}$, $\overline{\text{UDQS}}$ and $\overline{\text{RDQS}}$ to provide differential pair signaling to the system during both reads and writes. An EMR(1) control bit enables or disables all complementary data strobe signals.</p> <p>In this data sheet, "differential DQS signals" refers to any of the following with A10 = 0 of EMR(1)</p> <p style="margin-left: 40px;"> x4 DQS/$\overline{\text{DQS}}$ x8 DQS/$\overline{\text{DQS}}$ if EMR(1)[A11] = 0 x8 DQS/$\overline{\text{DQS}}$, RDQS/$\overline{\text{RDQS}}$, if EMR(1)[A11] = 1 x16 LDQS/$\overline{\text{LDQS}}$ and UDQS/$\overline{\text{UDQS}}$ </p> <p>"single-ended DQS signals" refers to any of the following with A10 = 1 of EMR(1)</p> <p style="margin-left: 40px;"> x4 DQS x8 DQS if EMR(1)[A11] = 0 x8 DQS, RDQS, if EMR(1)[A11] = 1 x16 LDQS and UDQS </p>

-Continued-

PIN	TYPE	DESCRIPTION
NC		No Connect : No internal electrical connection is present.
VDDQ	Supply	DQ Power Supply : 1.8V +/- 0.1V
VSSQ	Supply	DQ Ground
VDDL	Supply	DLL Power Supply : 1.8V +/- 0.1V
VSSDL	Supply	DLL Ground
VDD	Supply	Power Supply : 1.8V +/- 0.1V
VSS	Supply	Ground
VREF	Supply	Reference voltage.

2. Maximum DC Ratings

2.1 Absolute Maximum DC Ratings

Symbol	Parameter	Rating	Units	Notes
VDD	Voltage on VDD pin relative to Vss	- 1.0 V ~ 2.3 V	V	1
VDDQ	Voltage on VDDQ pin relative to Vss	- 0.5 V ~ 2.3 V	V	1
VDDL	Voltage on VDDL pin relative to Vss	- 0.5 V ~ 2.3 V	V	1
V _{IN} , V _{OUT}	Voltage on any pin relative to Vss	- 0.5 V ~ 2.3 V	V	1
T _{STG}	Storage Temperature	-55 to +100	°C	1, 2
I _I	Input leakage current; any input 0V VIN VDD; all other balls not under test = 0V)	-2 uA ~ 2 uA	uA	
I _{OZ}	Output leakage current; 0V VOUT VDDQ; DQ and ODT disabled	-5 uA ~ 5 uA	uA	

Note:

1. Stresses greater than those listed under "Absolute Maximum Ratings" may cause permanent damage to the device. This is a stress rating only and functional operation of the device at these or any other conditions above those indicated in the operational sections of this specification is not implied. Exposure to absolute maximum rating conditions for extended periods may affect reliability.
2. Storage Temperature is the case surface temperature on the center/top side of the DRAM. For the measurement conditions, please refer to JESD51-2 standard.

2.2 Operating Temperature Condition

Symbol	Parameter	Rating	Units	Notes
T _{OPER}	Operating Temperature	0 to 95	°C	1,2

Note:

1. Operating Temperature is the case surface temperature on the center/top side of the DRAM. For the measurement conditions, please refer to JESD51-2 standard.
2. At 85~95° T_{OPER}, Double refresh rate(tREFI: 3.9us) is required, and to enter the self refresh mode at this temperature range, an EMR command is required to change internal refresh rate.

3. AC & DC Operating Conditions

3.1 DC Operating Conditions

3.1.1 Recommended DC Operating Conditions (SSTL_1.8)

Symbol	Parameter	Rating			Units	Notes
		Min.	Typ.	Max.		
VDD	Supply Voltage	1.7	1.8	1.9	V	1
VDDL	Supply Voltage for DLL	1.7	1.8	1.9	V	1,2
VDDQ	Supply Voltage for Output	1.7	1.8	1.9	V	1,2
VREF	Input Reference Voltage	0.49*VDDQ	0.50*VDDQ	0.51*VDDQ	mV	3,4
VTT	Termination Voltage	VREF-0.04	VREF	VREF+0.04	V	5

Note:

1. Min. Typ. and Max. values increase by 100mV for C3(DDR2-533 3-3-3) speed option.
2. VDDQ tracks with VDD, VDDL tracks with VDD. AC parameters are measured with VDD, VDDQ and VDD.
3. The value of VREF may be selected by the user to provide optimum noise margin in the system. Typically the value of VREF is expected to be about 0.5 x VDDQ of the transmitting device and VREF is expected to track variations in VDDQ
4. Peak to peak ac noise on VREF may not exceed +/-2% VREF (dc).
5. VTT of transmitting device must track VREF of receiving device.

3.1.2 ODT DC electrical characteristics

PARAMETER/CONDITION	SYMBOL	MIN	NOM	MAX	UNITS	NOTES
Rtt effective impedance value for EMR(A6,A2)=0,1; 75 ohm	Rtt1(eff)	60	75	90	ohm	1
Rtt effective impedance value for EMR(A6,A2)=1,0; 150 ohm	Rtt2(eff)	120	150	180	ohm	1
Rtt effective impedance value for EMR(A6,A2)=1,1; 50 ohm	Rtt3(eff)	40	50	60	ohm	1
Deviation of VM with respect to VDDQ/2	delta VM	-6		+6	%	1

Note :

1. Test condition for Rtt measurements

Measurement Definition for Rtt(eff): Apply V_{IH} (ac) and V_{IL} (ac) to test pin separately, then measure current $I(V_{IH}$ (ac)) and $I(V_{IL}$ (ac)) respectively. V_{IH} (ac), V_{IL} (ac), and VDDQ values defined in SSTL_18

$$R_{tt}(\text{eff}) = \frac{V_{IH}(\text{ac}) - V_{IL}(\text{ac})}{I(V_{IH}(\text{ac})) - I(V_{IL}(\text{ac}))}$$

Measurement Definition for VM : Measurement Voltage at test pin(mid point) with no load.

$$\text{delta VM} = \left(\frac{2 \times V_m}{V_{DDQ}} - 1 \right) \times 100\%$$

3.2 DC & AC Logic Input Levels

3.2.1 Input DC Logic Level

Symbol	Parameter	Min.	Max.	Units	Notes
$V_{IH}(dc)$	dc input logic HIGH	$V_{REF} + 0.125$	$V_{DDQ} + 0.3$	V	
$V_{IL}(dc)$	dc input logic LOW	- 0.3	$V_{REF} - 0.125$	V	

3.2.2 Input AC Logic Level

Symbol	Parameter	DDR2 400,533		DDR2 667,800		Units	Notes
		Min.	Max.	Min.	Max.		
$V_{IH}(ac)$	ac input logic HIGH	$V_{REF} + 0.250$	-	$V_{REF} + 0.200$	-	V	
$V_{IL}(ac)$	ac input logic LOW	-	$V_{REF} - 0.250$	-	$V_{REF} - 0.200$	V	

3.2.3 AC Input Test Conditions

Symbol	Condition	Value	Units	Notes
V_{REF}	Input reference voltage	$0.5 * V_{DDQ}$	V	1
$V_{SWING(MAX)}$	Input signal maximum peak to peak swing	1.0	V	1
SLEW	Input signal minimum slew rate	1.0	V/ns	2, 3

Note:

1. Input waveform timing is referenced to the input signal crossing through the V_{REF} level applied to the device under test.
2. The input signal minimum slew rate is to be maintained over the range from V_{REF} to $V_{IH(ac)}$ min for rising edges and the range from V_{REF} to $V_{IL(ac)}$ max for falling edges as shown in the figure below.
3. AC timings are referenced with input waveforms switching from $V_{IL}(ac)$ to $V_{IH}(ac)$ on the positive transitions and $V_{IH}(ac)$ to $V_{IL}(ac)$ on the negative transitions.

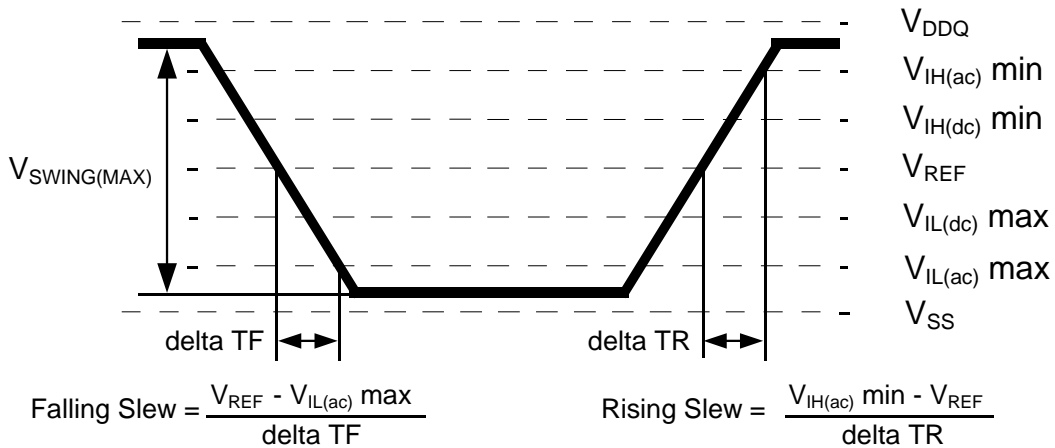

< Figure : AC Input Test Signal Waveform >

3.2.4 Differential Input AC logic Level

Symbol	Parameter	Min.	Max.	Units	Notes
$V_{ID}(ac)$	ac differential input voltage	0.5	$V_{DDQ} + 0.6$	V	1
$V_{IX}(ac)$	ac differential cross point voltage	$0.5 * V_{DDQ} - 0.175$	$0.5 * V_{DDQ} + 0.175$	V	2

Note:

- $V_{IN}(DC)$ specifies the allowable DC execution of each input of differential pair such as \overline{CK} , \overline{DQS} , \overline{LDQS} , \overline{UDQS} and \overline{UDQS} .
- $V_{ID}(DC)$ specifies the input differential voltage $|V_{TR} - V_{CP}|$ required for switching, where V_{TR} is the true input (such as \overline{CK} , \overline{DQS} , \overline{LDQS} or \overline{UDQS}) level and V_{CP} is the complementary input (such as \overline{CK} , \overline{DQS} , \overline{LDQS} or \overline{UDQS}) level.
The minimum value is equal to $V_{IH}(DC) - V_{IL}(DC)$.

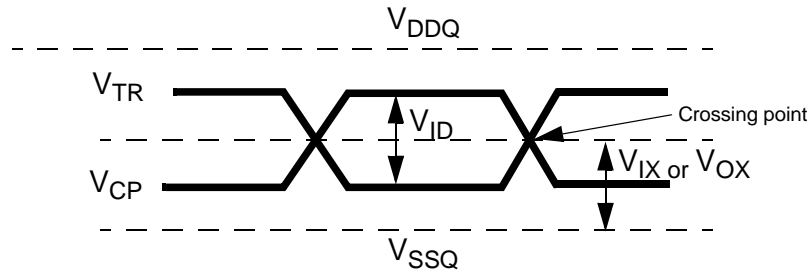

< Differential signal levels >

Note:

- $V_{ID}(AC)$ specifies the input differential voltage $|V_{TR} - V_{CP}|$ required for switching, where V_{TR} is the true input signal (such as \overline{CK} , \overline{DQS} , \overline{LDQS} or \overline{UDQS}) and V_{CP} is the complementary input signal (such as \overline{CK} , \overline{DQS} , \overline{LDQS} or \overline{UDQS}). The minimum value is equal to $V_{IH}(AC) - V_{IL}(AC)$.
- The typical value of $V_{IX}(AC)$ is expected to be about $0.5 * V_{DDQ}$ of the transmitting device and $V_{IX}(AC)$ is expected to track variations in V_{DDQ} . $V_{IX}(AC)$ indicates the voltage at which differential input signals must cross.

3.2.5 Differential AC output parameters

Symbol	Parameter	Min.	Max.	Units	Notes
$V_{OX}(ac)$	ac differential cross point voltage	$0.5 * V_{DDQ} - 0.125$	$0.5 * V_{DDQ} + 0.125$	V	1

Note:

- The typical value of $V_{OX}(AC)$ is expected to be about $0.5 * V_{DDQ}$ of the transmitting device and $V_{OX}(AC)$ is expected to track variations in V_{DDQ} . $V_{OX}(AC)$ indicates the voltage at which differential output signals must cross.

3.3 Output Buffer Characteristics

3.3.1 Output AC Test Conditions

Symbol	Parameter	SSTL_18 Class II	Units	Notes
V_{OTR}	Output Timing Measurement Reference Level	$0.5 * V_{DDQ}$	V	1

Note:

1. The VDDQ of the device under test is referenced.

3.3.2 Output DC Current Drive

Symbol	Parameter	SSTI_18	Units	Notes
$I_{OH(dc)}$	Output Minimum Source DC Current	- 13.4	mA	1, 3, 4
$I_{OL(dc)}$	Output Minimum Sink DC Current	13.4	mA	2, 3, 4

Note:

1. $V_{DDQ} = 1.7\text{ V}$; $V_{OUT} = 1420\text{ mV}$. $(V_{OUT} - V_{DDQ})/I_{OH}$ must be less than 21 ohm for values of V_{OUT} between V_{DDQ} and $V_{DDQ} - 280\text{ mV}$.
2. $V_{DDQ} = 1.7\text{ V}$; $V_{OUT} = 280\text{ mV}$. V_{OUT}/I_{OL} must be less than 21 ohm for values of V_{OUT} between 0 V and 280 mV.
3. The dc value of V_{REF} applied to the receiving device is set to V_{TT}
4. The values of $I_{OH(dc)}$ and $I_{OL(dc)}$ are based on the conditions given in Notes 1 and 2. They are used to test device drive current capability to ensure V_{IH} min plus a noise margin and V_{IL} max minus a noise margin are delivered to an SSTL_18 receiver. The actual current values are derived by shifting the desired driver operating point (see Section 3.3) along a 21 ohm load line to define a convenient driver current for measurement.

3.3.3 OCD default characteristics

Description	Parameter	Min	Nom	Max	Unit	Notes
Output impedance		-	-	-	ohms	1
Output impedance step size for OCD calibration		0		1.5	ohms	6
Pull-up and pull-down mismatch		0		4	ohms	1,2,3
Output slew rate	Sout	1.5	-	5	V/ns	1,4,5,6,7,8

Note :

1. Absolute Specifications (Toper; VDD = +1.8V ±0.1V, VDDQ = +1.8V ±0.1V)
2. Impedance measurement condition for output source dc current: VDDQ=1.7V; VOUT=1420mV; (VOUT-VDDQ)/Ioh must be less than 23.4 ohms for values of VOUT between VDDQ and VDDQ-280mV.
Impedance measurement condition for output sink dc current: VDDQ = 1.7V; VOUT = 280mV; VOUT/Iol must be less than 23.4 ohms for values of VOUT between 0V and 280mV.
3. Mismatch is absolute value between pull-up and pull-dn, both are measured at same temperature and voltage.
4. Slew rate measured from vil(ac) to vih(ac).
5. The absolute value of the slew rate as measured from DC to DC is equal to or greater than the slew rate as measured from AC to AC. This is guaranteed by design and characterization.
6. This represents the step size when the OCD is near 18 ohms at nominal conditions across all process corners/variations and represents only the DRAM uncertainty. A 0 ohm value(no calibration) can only be achieved if the OCD impedance is 18 ohms +/- 0.75 ohms under nominal conditions.

Output Slew rate load:

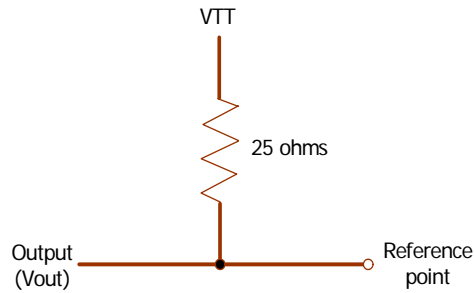

7. DRAM output slew rate specification applies to 400, 533 and 667 MT/s speed bins.
8. Timing skew due to DRAM output slew rate mis-match between DQS / DQS and associated DQs is included in tDQSQ and tQHS specification.

3.4 IDD Specifications & Test Conditions

IDD Specifications(max)

Symbol		DDR2 667		DDR2 800		Units
		x4/x8	x16	x4/x8	x16	
IDD0		80	-	80	-	mA
IDD1		100	-	100	-	mA
IDD2P		8	-	8	-	mA
IDD2Q		45	-	45	-	mA
IDD2N		50	-	50	-	mA
IDD3P	F	35	-	35	-	mA
	S	18	-	18	-	mA
IDD3N		55	-	55	-	mA
IDD4W		150	-	150	-	mA
IDD4R		170	-	170	-	mA
IDD5		230	-	230	-	mA
IDD6	Normal	8	-	8	-	mA
	Low power	7	-	7	-	mA
IDD7		295	-	295	-	mA

IDD Test Conditions

(IDD values are for full operating range of Voltage and Temperature, Notes 1-5)

Symbol	Conditions	Units	
IDD0	Operating one bank active-precharge current ; $t_{CK} = t_{CK}(IDD)$, $t_{RC} = t_{RC}(IDD)$, $t_{RAS} = t_{RASmin}(IDD)$; CKE is HIGH, \overline{CS} is HIGH between valid commands; Address bus inputs are SWITCHING; Data bus inputs are SWITCHING	mA	
IDD1	Operating one bank active-read-precharge current ; $I_{OUT} = 0mA$; $BL = 4$, $CL = CL(IDD)$, $AL = 0$; $t_{CK} = t_{CK}(IDD)$, $t_{RC} = t_{RC}(IDD)$, $t_{RAS} = t_{RASmin}(IDD)$, $t_{RCD} = t_{RCD}(IDD)$; CKE is HIGH, \overline{CS} is HIGH between valid commands; Address bus inputs are SWITCHING; Data pattern is same as IDD4W	mA	
IDD2P	Precharge power-down current ; All banks idle; $t_{CK} = t_{CK}(IDD)$; CKE is LOW; Other control and address bus inputs are STABLE; Data bus inputs are FLOATING	mA	
IDD2Q	Precharge quiet standby current ; All banks idle; $t_{CK} = t_{CK}(IDD)$; CKE is HIGH, \overline{CS} is HIGH; Other control and address bus inputs are STABLE; Data bus inputs are FLOATING	mA	
IDD2N	Precharge standby current ; All banks idle; $t_{CK} = t_{CK}(IDD)$; CKE is HIGH, \overline{CS} is HIGH; Other control and address bus inputs are SWITCHING; Data bus inputs are SWITCHING	mA	
IDD3P	Active power-down current ; All banks open; $t_{CK} = t_{CK}(IDD)$; CKE is LOW; Other control and address bus inputs are STABLE; Data bus inputs are FLOATING	Fast PDN Exit MR(12) = 0	mA
		Slow PDN Exit MR(12) = 1	mA
IDD3N	Active standby current ; All banks open; $t_{CK} = t_{CK}(IDD)$, $t_{RAS} = t_{RASmax}(IDD)$, $t_{RP} = t_{RP}(IDD)$; CKE is HIGH, \overline{CS} is HIGH between valid commands; Other control and address bus inputs are SWITCHING; Data bus inputs are SWITCHING	mA	
IDD4W	Operating burst write current ; All banks open, Continuous burst writes; $BL = 4$, $CL = CL(IDD)$, $AL = 0$; $t_{CK} = t_{CK}(IDD)$, $t_{RAS} = t_{RASmax}(IDD)$, $t_{RP} = t_{RP}(IDD)$; CKE is HIGH, \overline{CS} is HIGH between valid commands; Address bus inputs are SWITCHING; Data bus inputs are SWITCHING	mA	
IDD4R	Operating burst read current ; All banks open, Continuous burst reads, $I_{OUT} = 0mA$; $BL = 4$, $CL = CL(IDD)$, $AL = 0$; $t_{CK} = t_{CK}(IDD)$, $t_{RAS} = t_{RASmax}(IDD)$, $t_{RP} = t_{RP}(IDD)$; CKE is HIGH, \overline{CS} is HIGH between valid commands; Address bus inputs are SWITCHING; Data pattern is same as IDD4W	mA	
IDD5B	Burst refresh current ; $t_{CK} = t_{CK}(IDD)$; Refresh command at every $t_{RFC}(IDD)$ interval; CKE is HIGH, \overline{CS} is HIGH between valid commands; Other control and address bus inputs are SWITCHING; Data bus inputs are SWITCHING	mA	
IDD6	Self refresh current ; CK and \overline{CK} at 0V; $CKE \leq 0.2V$; Other control and address bus inputs are FLOATING; Data bus inputs are FLOATING	mA	
IDD7	Operating bank interleave read current ; All bank interleaving reads, $I_{OUT} = 0mA$; $BL = 4$, $CL = CL(IDD)$, $AL = t_{RCD}(IDD) - 1 * t_{CK}(IDD)$; $t_{CK} = t_{CK}(IDD)$, $t_{RC} = t_{RC}(IDD)$, $t_{RRD} = t_{RRD}(IDD)$, $t_{RCD} = 1 * t_{CK}(IDD)$; CKE is HIGH, \overline{CS} is HIGH between valid commands; Address bus inputs are STABLE during DESELECTs; Data pattern is same as IDD4R; - Refer to the following page for detailed timing conditions	mA	

Note :

1. VDDQ = 1.8 +/- 0.1V ; VDD = 1.8 +/- 0.1V (exclusively VDDQ = 1.9 +/- 0.1V ; VDD = 1.9 +/- 0.1V for C3 speed grade)
2. IDD specifications are tested after the device is properly initialized
3. Input slew rate is specified by AC Parametric Test Condition
4. IDD parameters are specified with ODT disabled.
5. Data bus consists of DQ, DM, DQS, $\overline{\text{DQS}}$, RDQS, $\overline{\text{RDQS}}$, LDQS, $\overline{\text{LDQS}}$, UDQS, and $\overline{\text{UDQS}}$. IDD values must be met with all combinations of EMR bits 10 and 11.
6. For DDR2-667/800 testing, tCK in the COnditions should be interpreted as tCK(avg).
7. Definitions for IDD
 - LOW is defined as $V_{in} \leq V_{ILAC}(\text{max})$
 - HIGH is defined as $V_{in} \geq V_{IHAC}(\text{min})$
 - STABLE is defined as inputs stable at a HIGH or LOW level
 - FLOATING is defined as inputs at $V_{REF} = V_{DDQ}/2$
 - SWITCHING is defined as: inputs changing between HIGH and LOW every other clock cycle (once per two clocks) for address and control signals, and inputs changing between HIGH and LOW every other data transfer (once per clock) for DQ signals not including masks or strobes.

IDD Testing Parameters

For purposes of IDD testing, the following parameters are to be utilized.

Parameter	DDR2-800		DDR2-667	DDR2-533	DDR2-400	Units
	5-5-5	6-6-6	5-5-5	4-4-4	3-3-3	
CL(IDD)	5	6	5	4	3	tCK
t _{RCD} (IDD)	12.5	15	15	15	15	ns
t _{RC} (IDD)	57.5	60	60	60	55	ns
t _{RRD} (IDD)-x4/x8	7.5	7.5	7.5	7.5	7.5	ns
t _{RRD} (IDD)-x16	10	10	10	10	10	ns
t _{CK} (IDD)	2.5	2.5	3	3.75	5	ns
t _{RASmin} (IDD)	45	45	45	45	40	ns
t _{RASmax} (IDD)	70000	70000	70000	70000	70000	ns
t _{RP} (IDD)	12.5	15	15	15	15	ns
t _{RFC} (IDD)-256Mb	75	75	75	75	75	ns
t _{RFC} (IDD)-512Mb	105	105	105	105	105	ns
t _{RFC} (IDD)-1Gb	127.5	127.5	127.5	127.5	127.5	ns
t _{RFC} (IDD)-2Gb	197.5	197.5	197.5	197.5	197.5	ns
t _{RFC} (IDD)-4Gb	327.5	327.5	327.5	327.5	327.5	327.5

Detailed IDD7

The detailed timings are shown below for IDD7. Changes will be required if timing parameter changes are made to the specification.

Legend: A = Active; RA = Read with Autoprecharge; D = Deselect

IDD7: Operating Current: All Bank Interleave Read operation

All banks are being interleaved at minimum t_{RC}(IDD) without violating t_{RRD}(IDD) and t_{FAW}(IDD) using a burst length of 4. Control and address bus inputs are STABLE during DESELECTs. IOUT = 0mA

Timing Patterns for 4 bank devices x4/ x8/ x16

-DDR2-400 4/4/4: A0 RA0 A1 RA1 A2 RA2 A3 RA3 D D D D
 -DDR2-400 3/3/3: A0 RA0 A1 RA1 A2 RA2 A3 RA3 D D D D
 -DDR2-533 4/4/4: A0 RA0 D A1 RA1 D A2 RA2 D A3 RA3 D D D D
 -DDR2-533 3/3/3: A0 RA0 D A1 RA1 D A2 RA2 D A3 RA3 D D D D
 -DDR2-667 5/5/5: A0 RA0 D D A1 RA1 D D A2 RA2 D D A3 RA3 D D D D D D
 -DDR2-667 4/4/4: A0 RA0 D D A1 RA1 D D A2 RA2 D D A3 RA3 D D D D D D
 -DDR2-800 6/6/6: A0 RA0 D D A1 RA1 D D A2 RA2 D D A3 RA3 D D D D D D D D D D
 -DDR2-800 5/5/5: A0 RA0 D D A1 RA1 D D A2 RA2 D D A3 RA3 D D D D D D D D D D
 -DDR2-800 4/4/4: A0 RA0 D D A1 RA1 D D A2 RA2 D D A3 RA3 D D D D D D D D D D

Timing Patterns for 8 bank devices x4/8

-DDR2-400 all bins: A0 RA0 A1 RA1 A2 RA2 A3 RA3 A4 RA4 A5 RA5 A6 RA6 A7 RA7
 -DDR2-533 all bins: A0 RA0 A1 RA1 A2 RA2 A3 RA3 D D A4 RA4 A5 RA5 A6 RA6 A7 RA7 D D
 -DDR2-667 all bins: A0 RA0 D A1 RA1 D A2 RA2 D A3 RA3 D D A4 RA4 D A5 RA5 D A6 RA6 D A7 RA7 D D

-DDR2-800 all bins: A0 RA0 D A1 RA1 D A2 RA2 D A3 RA3 D D D A4 RA4 D A5 RA5 D A6 RA6 D A7 RA7 D D D

Timing Patterns for 8 bank devices x16

-DDR2-400 all bins: A0 RA0 A1 RA1 A2 RA2 A3 RA3 D D A4 RA4 A5 RA5 A6 RA6 A7 RA7 D D

-DDR2-533 all bins: A0 RA0 D A1 RA1 D A2 RA2 D A3 RA3 D D D A4 RA4 D A5 D A6 RA6 D A7 RA7 D D D

-DDR2-667 all bins: A0 RA0 D D A1 RA1 D D A2 RA2 D D A3 RA3 D D D A4 RA4 D D A5 RA5 D D A6 RA6 D D A7 RA7 D D D

-DDR2-800 all bins: A0 RA0 D D A1 RA1 D D A2 RA2 D D A3 RA3 D D D D A4 RA4 D D A5 RA5 D D A6 RA6 D D A7 RA7 D D D D

3.5. Input/Output Capacitance

Parameter	Symbol	DDR2 400 DDR2 533		DDR2 667		DDR2 800		Units
		Min	Max	Min	Max	Min	Max	
Input capacitance, CK and \overline{CK}	CCK	1.0	2.0	1.0	2.0	1.0	2.0	pF
Input capacitance delta, CK and \overline{CK}	CDCK	x	0.25	x	0.25	x	0.25	pF
Input capacitance, all other input-only pins	CI	1.0	2.0	1.0	2.0	1.0	1.75	pF
Input capacitance delta, all other input-only pins	CDI	x	0.25	x	0.25	x	0.25	pF
Input/output capacitance, DQ, DM, DQS, \overline{DQS}	CIO	2.5	4.0	2.5	3.5	2.5	3.5	pF
Input/output capacitance delta, DQ, DM, DQS, \overline{DQS}	CDIO	x	0.5	x	0.5	x	0.5	pF

4. Electrical Characteristics & AC Timing Specification

(T_{OPER} ; $V_{DDQ} = 1.8 \pm 0.1V$; $V_{DD} = 1.8 \pm 0.1V$)

Refresh Parameters by Device Density

Parameter	Symbol	256Mb	512Mb	1Gb	2Gb	4Gb	Units	Notes	
Refresh to Active/Refresh command time	tRFC	75	105	127.5	195	327.5	ns	1	
Average periodic refresh interval	tREFI	$0\text{ }^{\circ}\text{C} \leq T_{CASE} \leq 85\text{ }^{\circ}\text{C}$	7.8	7.8	7.8	7.8	7.8	us	1
		$85\text{ }^{\circ}\text{C} < T_{CASE} \leq 95\text{ }^{\circ}\text{C}$	3.9	3.9	3.9	3.9	3.9	us	1,2

Note :

1: If refresh timing is violated, data corruption may occur and the data must be re-written with valid data before a valid READ can be executed.

2. This is an optional feature. For detailed information, please refer to "operating temperature condition" in this data sheet.

DDR2 SDRAM speed bins and tRCD, tRP and tRC for corresponding bin

Speed	DDR2-800		DDR2-667		DDR2-533	DDR2-400	Units	Notes
Parameter	min	min	min	min	min	min		
Bin(CL-tRCD-tRP)	5-5-5	6-6-6	4-4-4	5-5-5	4-4-4	3-3-3		
CAS Latency	5	6	4	5	4	3	tCK	
tRCD	12.5	15	12	15	15	15	ns	2
tRP*1	12.5	15	12	15	15	15	ns	2
tRAS	45	45	45	45	45	40	ns	2,3
tRC	57.5	60	57	60	60	55	ns	2

Note :

1. 8 bank device Precharge All Allowance : tRP for a Precharge All command for an 8 Bank device will equal to $tRP + 1 * tCK$, where tRP are the values for a single bank Precharge, which are shown in the table above.

2. Refer to Specific Notes 32.

3. Refer to Specific Notes 3.

Timing Parameters by Speed Grade (DDR2-400 and DDR2-533)

Parameter	Symbol	DDR2-400		DDR2-533		Unit	Note
		min	max	min	max		
DQ output access time from CK/ $\overline{\text{CK}}$	tAC	-600	+600	-500	+500	ps	
DQS output access time from CK/ $\overline{\text{CK}}$	tDQSCK	-500	+500	-450	+450	ps	
CK HIGH pulse width	tCH	0.45	0.55	0.45	0.55	tCK	
CK LOW pulse width	tCL	0.45	0.55	0.45	0.55	tCK	
CK half period	tHP	min(tCL, tCH)	-	min(tCL, tCH)	-	ps	11,12
Clock cycle time, CL=x	tCK	5000	8000	3750	8000	ps	15
DQ and DM input setup time(differential strobe)	tDS(base)	150	-	100	-	ps	6,7,8,20 ,28
DQ and DM input hold time(differential strobe)	tDH(base)	275	-	225	-	ps	6,7,8,21 ,28
DQ and DM input setup time(single ended strobe)	tDS(base)	25	-	-25	-	ps	6,7,8,25
DQ and DM input hold time(single ended strobe)	tDH(base)	25	-	-25	-	ps	6,7,8,26
Control & Address input pulse width for each input	tIPW	0.6	-	0.6	-	tCK	
DQ and DM input pulse width for each input	tDIPW	0.35	-	0.35	-	tCK	
Data-out high-impedance time from CK/ $\overline{\text{CK}}$	tHZ	-	tAC max	-	tAC max	ps	18
DQS low-impedance time from CK/ $\overline{\text{CK}}$	tLZ (DQS)	tAC min	tAC max	tAC min	tAC max	ps	18
DQ low-impedance time from CK/ $\overline{\text{CK}}$	tLZ (DQ)	2*tAC min	tAC max	2*tAC min	tAC max	ps	18
DQS-DQ skew for DQS and associated DQ signals	tDQSQ	-	350	-	300	ps	13
DQ hold skew factor	tQHS	-	450	-	400	ps	12
DQ/DQS output hold time from DQS	tQH	tHP - tQHS	-	tHP - tQHS	-	ps	
Write command to first DQS latching transition	tDQSS	WL - 0.25	WL + 0.25	WL - 0.25	WL + 0.25	tCK	
DQS input HIGH pulse width	tDQSH	0.35	-	0.35	-	tCK	
DQS input LOW pulse width	tDQSL	0.35	-	0.35	-	tCK	
DQS falling edge to CK setup time	tDSS	0.2	-	0.2	-	tCK	
DQS falling edge hold time from CK	tDSH	0.2	-	0.2	-	tCK	
Mode register set command cycle time	tMRD	2	-	2	-	tCK	
Write preamble	tWPRE	0.35	-	0.35	-	tCK	
Write postamble	tWPST	0.4	0.6	0.4	0.6	tCK	10
Address and control input setup time	tIS	350	-	250	-	ps	5,7,9,23
Address and control input hold time	tIH	475	-	375	-	ps	5,7,9,23
Read preamble	tRPRE	0.9	1.1	0.9	1.1	tCK	19
Read postamble	tRPST	0.4	0.6	0.4	0.6	tCK	19
Active to active command period for 1KB page size products (x4, x8)	tRRD	7.5	-	7.5	-	ns	4
Active to active command period for 2KB page size products (x16)	tRRD	10	-	10	-	ns	4

-Continued-

Parameter	Symbol	DDR2-400		DDR2-533		Units	Notes
		min	max	min	max		
Four Active Window for 1KB page size products	tFAW	37.5	-	37.5	-	ns	
Four Active Window for 2KB page size products	tFAW	50	-	50	-	ns	
CAS to CAS command delay	tCCD	2		2		tCK	
Write recovery time	tWR	15	-	15	-	ns	
Auto precharge write recovery + precharge time	tDAL	WR+tRP*	-	WR+tRP*	-	tCK	14
Internal write to read command delay	tWTR	10	-	7.5	-	ns	24
Internal read to precharge command delay	tRTP	7.5		7.5		ns	3
Exit self refresh to a non-read command	tXSNR	tRFC + 10		tRFC + 10		ns	
Exit self refresh to a read command	tXSRD	200	-	200	-	tCK	
Exit precharge power down to any non-read command	tXP	2	-	2	-	tCK	
Exit active power down to read command	tXARD	2		2		tCK	1
Exit active power down to read command (Slow exit, Lower power)	tXARDS	6 - AL		6 - AL		tCK	1, 2
CKE minimum pulse width (HIGH and LOW pulse width)	tCKE	3		3		tCK	27
ODT turn-on delay	tAOND	2	2	2	2	tCK	16
ODT turn-on	tAON	tAC(min)	tAC(max)+1	tAC(min)	tAC(max)+1	ns	16
ODT turn-on(Power-Down mode)	tAONPD	tAC(min)+2	2tCK+tAC(max)+1	tAC(min)+2	2tCK+tAC(max)+1	ns	
ODT turn-off delay	tAOFD	2.5	2.5	2.5	2.5	tCK	17,44
ODT turn-off	tAOF	tAC(min)	tAC(max)+0.6	tAC(min)	tAC(max)+0.6	ns	17,44
ODT turn-off (Power-Down mode)	tAOFPD	tAC(min)+2	2.5tCK+tAC(max)+1	tAC(min)+2	2.5tCK+tAC(max)+1	ns	
ODT to power down entry latency	tANPD	3		3		tCK	
ODT power down exit latency	tAXPD	8		8		tCK	
OCD drive mode output delay	tOIT	0	12	0	12	ns	
Minimum time clocks remains ON after CKE asynchronously drops LOW	tDelay	tIS+tCK+tIH		tIS+tCK+tIH		ns	15

(DDR2-667 and DDR2-800)

Parameter	Symbol	DDR2-667		DDR2-800		Unit	Note
		min	max	min	max		
DQ output access time from CK/CK	tAC	-450	+450	-400	+400	ps	40
DQS output access time from CK/CK	tDQSK	-400	+400	-350	+350	ps	40
CK HIGH pulse width	tCH(avg)	0.48	0.52	0.48	0.52	tCK(av g)	35,36
CK LOW pulse width	tCL(avg)	0.48	0.52	0.48	0.52	tCK(av g)	35,36
CK half period	tHP	min(tCL(abs), tCH(abs))	-	min(tCL(abs), tCH(abs))	-	ps	37
Clock cycle time, CL=x	tCK(avg)	3000	8000	2500	8000	ps	35,36
DQ and DM input setup time	tDS(base)	100	-	50	-	ps	6,7,8,20,28, 31
DQ and DM input hold time	tDH(base)	175	-	125	-	ps	6,7,8,21,28, 31
Control & Address input pulse width for each input	tIPW	0.6	-	0.6	-	tCK(av g)	
DQ and DM input pulse width for each input	tDIPW	0.35	-	0.35	-	tCK(av g)	
Data-out high-impedance time from CK/CK	tHZ	-	tAC max	-	tAC max	ps	18,40
DQS low-impedance time from CK/CK	tLZ(DQS)	tAC min	tAC max	tAC min	tAC max	ps	18,40
DQ low-impedance time from CK/CK	tLZ(DQ)	2*tAC min	tAC max	2*tAC min	tAC max	ps	18,40
DQS-DQ skew for DQS and associated DQ signals	tDQSQ	-	240	-	200	ps	13
DQ hold skew factor	tQHS	-	340	-	300	ps	38
DQ/DQS output hold time from DQS	tQH	tHP - tQHS	-	tHP - tQHS	-	ps	39
First DQS latching transition to associated clock edge	tDQSS	- 0.25	+ 0.25	- 0.25	+ 0.25	tCK(av g)	30
DQS input HIGH pulse width	tDQSH	0.35	-	0.35	-	tCK(av g)	
DQS input LOW pulse width	tDQSL	0.35	-	0.35	-	tCK(av g)	
DQS falling edge to CK setup time	tDSS	0.2	-	0.2	-	tCK(av g)	30
DQS falling edge hold time from CK	tDSH	0.2	-	0.2	-	tCK(av g)	30
Mode register set command cycle time	tMRD	2	-	2	-	tCK(av g)	
Write preamble	tWPRE	0.35	-	0.35	-	tCK(av g)	
Write postamble	tWPST	0.4	0.6	0.4	0.6	tCK(av g)	10
Address and control input setup time	tIS(base)	200	-	175	-	ps	5,7,9,22,29
Address and control input hold time	tIH(base)	275	-	250	-	ps	5,7,9,23,29
Read preamble	tRPRE	0.9	1.1	0.9	1.1	tCK(av g)	19,41

-Continued-

Parameter	Symbol	DDR2-667		DDR2-800		Unit	Notes
		min	max	min	max		
Internal write to read command delay	tWTR	7.5	-	7.5	-	ns	24,32
Internal read to precharge command delay	tRTP	7.5		7.5		ns	3,32
Exit self refresh to a non-read command	tXSNR	tRFC + 10		tRFC + 10		ns	32
Exit self refresh to a read command	tXSRD	200	-	200	-	nCK	
Exit precharge power down to any non-read command	tXP	2	-	2	-	nCK	
Exit active power down to read command	tXARD	2		2		nCK	1
Exit active power down to read command (Slow exit, Lower power)	tXARDS	7 - AL		8 - AL		nCK	1, 2
CKE minimum pulse width (HIGH and LOW pulse width)	tCKE	3		3		nCK	27
ODT turn-on delay	tAOND	2	2	2	2	nCK	16
ODT turn-on	tAON	tAC(min)	tAC(max)+0.7	tAC(min)	tAC(max)+0.7	ns	6,16,40
ODT turn-on(Power-Down mode)	tAONPD	tAC(min)+2	2tCK(avg)+tAC(max)+1	tAC(min)+2	2tCK(avg)+tAC(max)+1	ns	
ODT turn-off delay	tAOFD	2.5	2.5	2.5	2.5	nCK	17,45
ODT turn-off	tAOF	tAC(min)	tAC(max)+0.6	tAC(min)	tAC(max)+0.6	ns	17,43,45
ODT turn-off (Power-Down mode)	tAOFPD	tAC(min)+2	2.5tCK(avg)+tAC(max)+1	tAC(min)+2	2.5tCK(avg)+tAC(max)+1	ns	
ODT to power down entry latency	tANPD	3		3		nCK	
ODT power down exit latency	tAXPD	8		8		nCK	
OCD drive mode output delay	tOIT	0	12	0	12	ns	32
Minimum time clocks remains ON after CKE asynchronously drops LOW	tDelay	tIS+tCK(avg)+tIH		tIS+tCK(av)+tIH		ns	15

General notes, which may apply for all AC parameters

1. DDR2 SDRAM AC timing reference load

The following figure represents the timing reference load used in defining the relevant timing parameters of the part. It is not intended to be either a precise representation of the typical system environment nor a depiction of the actual load presented by a production tester. System designers will use IBIS or other simulation tools to correlate the timing reference load to a system environment. Manufacturers will correlate to their production test conditions (generally a coaxial transmission line terminated at the tester electronics).

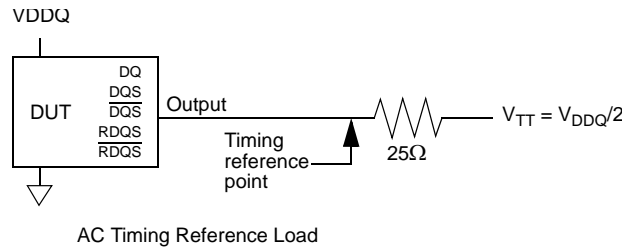

The output timing reference voltage level for single ended signals is the crosspoint with V_{TT} . The output timing reference voltage level for differential signals is the crosspoint of the true (e.g. \overline{DQS}) and the complement (e.g. \overline{DQS}) signal.

2. Slew Rate Measurement Levels

- a. Output slew rate for falling and rising edges is measured between $V_{TT} - 250$ mV and $V_{TT} + 250$ mV for single ended signals. For differential signals (e.g. $\overline{DQS} - \overline{DQS}$) output slew rate is measured between $\overline{DQS} - \overline{DQS} = -500$ mV and $\overline{DQS} - \overline{DQS} = +500$ mV. Output slew rate is guaranteed by design, but is not necessarily tested on each device.
- b. Input slew rate for single ended signals is measured from dc-level to ac-level: from $V_{REF} - 125$ mV to $V_{REF} + 250$ mV for rising edges and from $V_{REF} + 125$ mV and $V_{REF} - 250$ mV for falling edges. For differential signals (e.g. $\overline{CK} - \overline{CK}$) slew rate for rising edges is measured from $\overline{CK} - \overline{CK} = -250$ mV to $\overline{CK} - \overline{CK} = +500$ mV (+250mV to -500 mV for falling edges).
- c. VID is the magnitude of the difference between the input voltage on \overline{CK} and the input voltage on \overline{CK} , or between \overline{DQS} and \overline{DQS} for differential strobe.

3. DDR2 SDRAM output slew rate test load

Output slew rate is characterized under the test conditions as shown below.

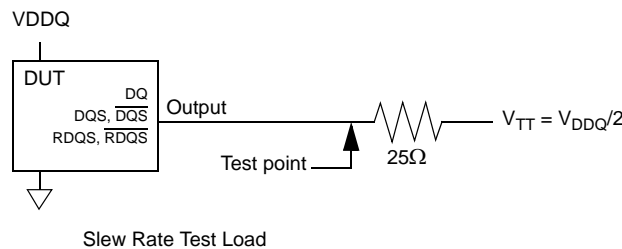

4. Differential data strobe

DDR2 SDRAM pin timings are specified for either single ended mode or differential mode depending on the setting of the EMR "Enable DQS" mode bit; timing advantages of differential mode are realized in system design. The method by which the DDR2 SDRAM pin timings are measured is mode dependent. In single ended mode, timing relationships are measured relative to the rising or falling edges of DQS crossing at VREF. In differential mode, these timing relationships are measured relative to the crosspoint of DQS and its complement, \overline{DQS} . This distinction in timing methods is guaranteed by design and characterization. Note that when differential data strobe mode is disabled via the EMR, the complementary pin, \overline{DQS} , must be tied externally to VSS through a 20 Ω to 10 K Ω resistor to insure proper operation.

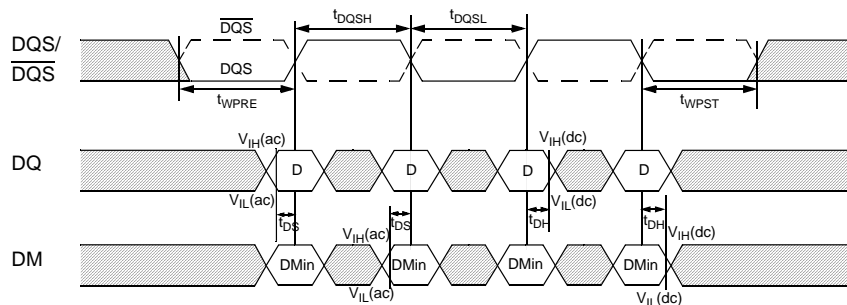

Figure -- Data input (write) timing

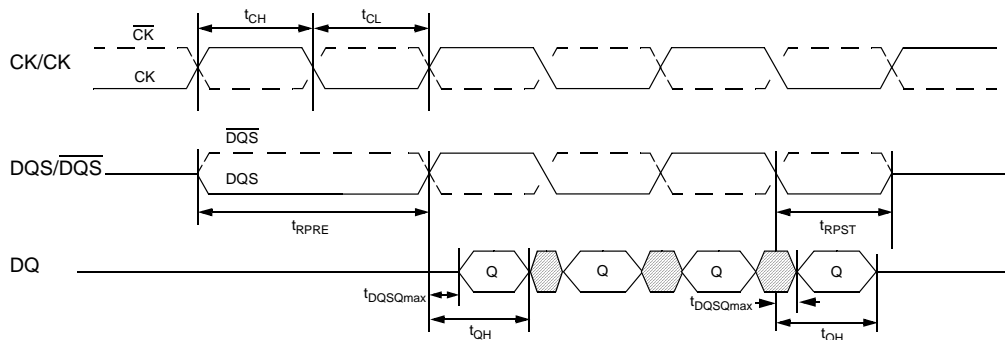

Figure -- Data output (read) timing

5. AC timings are for linear signal transitions. See System Derating for other signal transitions.
6. All voltages referenced to VSS.
7. These parameters guarantee device behavior, but they are not necessarily tested on each device. They may be guaranteed by device design or tester correlation.
8. Tests for AC timing, IDD, and electrical (AC and DC) characteristics, may be conducted at nominal reference/supply voltage levels, but the related specifications and device operation are guaranteed for the full voltage range specified.

Specific Notes for dedicated AC parameters

1. User can choose which active power down exit timing to use via MRS(bit 12). tXARD is expected to be used for fast active power down exit timing. tXARDS is expected to be used for slow active power down exit timing where a lower power value is defined by each vendor data sheet.
2. AL = Additive Latency
3. This is a minimum requirement. Minimum read to precharge timing is AL + BL/2 providing the tRTP and tRAS(min) have been satisfied.
4. A minimum of two clocks (2 * tCK or 2 * nCK) is required irrespective of operating frequency
5. Timings are specified with command/address input slew rate of 1.0 V/ns. See System Derating for other slew rate values.
6. Timings are guaranteed with DQs, DM, and DQS's(DQS/RDQS in singled ended mode) input slew rate of 1.0 V/ns. See System Derating for other slew rate values.
7. Timings are specified with CK/CK differential slew rate of 2.0 V/ns. Timings are guaranteed for DQS signals with a differential slew rate of 2.0 V/ns in differential strobe mode and a slew rate of 1V/ns in single ended mode. See System Derating for other slew rate values.
8. tDS and tDH derating

tDS, tDH Derating Values for DDR2-400, DDR2-533(ALL units in 'ps', Note 1 applies to entire Table)																			
		DQS, DQS Differential Slew Rate																	
		4.0 V/ns		3.0 V/ns		2.0 V/ns		1.8 V/ns		1.6 V/ns		1.4 V/ns		1.2 V/ns		1.0 V/ns		0.8 V/ns	
		Δ tDS	Δ tDH	Δ tDS	Δ tDH	Δ tDS	Δ tDH	Δ tDS	Δ tDH	Δ tDS	Δ tDH	Δ tDS	Δ tDH	Δ tDS	Δ tDH	Δ tDS	Δ tDH	Δ tDS	Δ tDH
DQ Slew rate V/ns	2.0	125	45	125	45	+125	+45	-	-	-	-	-	-	-	-	-	-	-	-
	1.5	83	21	83	21	+83	+21	95	33	-	-	-	-	-	-	-	-	-	-
	1.0	0	0	0	0	0	0	12	12	24	24	-	-	-	-	-	-	-	-
	0.9	-	-	-11	-14	-11	-14	1	-2	13	10	25	22	-	-	-	-	-	-
	0.8	-	-	-	-	-25	-31	-13	-19	-1	-7	11	5	23	17	-	-	-	-
	0.7	-	-	-	-	-	-	-31	-42	-42	-19	-7	-8	5	-6	17	6	-	-
	0.6	-	-	-	-	-	-	-	-	-43	-59	-31	-47	-19	-35	-7	-23	5	-11
	0.5	-	-	-	-	-	-	-	-	-	-	-74	-89	-62	-77	-50	-65	-38	-53
tDS, tDH Derating Values for DDR2-667, DDR2-800(ALL units in 'ps', Note 1 applies to entire Table)																			
		DQS, DQS Differential Slew Rate																	
		4.0 V/ns		3.0 V/ns		2.0 V/ns		1.8 V/ns		1.6 V/ns		1.4 V/ns		1.2 V/ns		1.0 V/ns		0.8 V/ns	
		Δ tDS	Δ tDH	Δ tDS	Δ tDH	Δ tDS	Δ tDH	Δ tDS	Δ tDH	Δ tDS	Δ tDH	Δ tDS	Δ tDH	Δ tDS	Δ tDH	Δ tDS	Δ tDH	Δ tDS	Δ tDH
DQ Slew rate V/ns	2.0	100	45	100	45	100	45	-	-	-	-	-	-	-	-	-	-	-	-
	1.5	67	21	67	21	67	21	79	33	-	-	-	-	-	-	-	-	-	-
	1.0	0	0	0	0	0	0	12	12	24	24	-	-	-	-	-	-	-	-
	0.9	-	-	-5	-14	-5	-14	7	-2	19	10	31	22	-	-	-	-	-	-
	0.8	-	-	-	-	-13	-31	-1	-19	11	-7	23	5	35	17	-	-	-	-
	0.7	-	-	-	-	-	-	-10	-42	2	-30	14	-18	26	-6	38	6	-	-
	0.6	-	-	-	-	-	-	-	-	-10	-59	2	-47	14	-35	26	-23	38	-11
	0.5	-	-	-	-	-	-	-	-	-	-	-24	-89	-12	-77	0	-65	12	-53
0.4	-	-	-	-	-	-	-	-	-	-	-	-	-52	-140	-40	-128	-28	-116	

1) For all input signals the total tDS(setup time) and tDH(hold time) required is calculated by adding the datasheet value to the derating
Rev. 0.3 / May 2008 28

tDS, tDH Derating Values for DDR2-400, DDR2-533(ALL units in 'ps', Note 1 applies to entire Table)																			
		DQS, \overline{DQS} Single-ended Slew Rate																	
		4.0 V/ns		3.0 V/ns		2.0 V/ns		1.8 V/ns		1.6 V/ns		1.4 V/ns		1.2 V/ns		1.0 V/ns		0.8 V/ns	
		Δ tDS	Δ tDH	Δ tDS	Δ tDH	Δ tDS	Δ tDH	Δ tDS	Δ tDH	Δ tDS	Δ tDH	Δ tDS	Δ tDH	Δ tDS	Δ tDH	Δ tDS	Δ tDH	Δ tDS	Δ tDH
DQ Slew rate V/ns	2.0	188	188	167	146	125	63	-	-	-	-	-	-	-	-	-	-	-	-
	1.5	146	167	125	125	83	42	81	43	-	-	-	-	-	-	-	-	-	-
	1.0	63	125	42	83	0	0	-2	1	-7	-13	-	-	-	-	-	-	-	-
	0.9	-	-	31	69	-11	-14	-13	-13	-18	-27	-29	-45	-	-	-	-	-	-
	0.8	-	-	-	-	-25	-31	-27	-30	-32	-44	-43	-62	-60	-86	-	-	-	-
	0.7	-	-	-	-	-	-	-45	-53	-50	-67	-61	-85	-78	-109	-108	-152	-	-
	0.6	-	-	-	-	-	-	-	-	-74	-96	-85	-114	-102	-138	-132	-181	-183	-248
	0.5	-	-	-	-	-	-	-	-	-	-	-128	-156	-145	-180	-175	-223	-226	-288
	0.4	-	-	-	-	-	-	-	-	-	-	-	-	-210	-243	-240	-286	-291	-351

value listed in Table x.

Setup(tDS) nominal slew rate for a rising signal is defined as the slew rate between the last crossing of VREF(dc) and the first crossing of Vih(ac)min. Setup(tDS) nominal slew rate for a falling signal is defined as the slew rate between the last crossing of VREF(dc) and the first crossing of Vil(ac)max. If the actual signal is always earlier than the nominal slew rate line between shaded 'VREF(dc) to ac region', use nominal slew rate for derating value(see Fig a.) If the actual signal is later than the nominal slew rate line anywhere between shaded 'VREF(dc) to ac region', the slew rate of a tangent line to the actual signal from the ac level to dc level is used for derating value(see Fig b.)

Hold(tDH) nominal slew rate for a rising signal is defined as the slew rate between the last crossing of Vil(dc) max and the first crossing of VREF(dc). Hold (tDH) nominal slew rate for a falling signal is defined as the slew rate between the last crossing of Vih(dc) min and the first crossing of VREF(dc). If the actual signal is always later than the nominal slew rate line anywhere between shaded 'dc to VREF(dc) region', the slew rate of a tangent line to the actual signal from the dc level to VREF(dc) level is used for derating value(see Fig c.) If the actual signal is earlier than the nominal slew rate line anywhere between shaded 'dc to VREF(dc) region', the slew rate of a tangent line to the actual signal from the dc level to VREF(dc) level is used for derating value(see Fig d.)

Although for slow slew rates the total setup time might be negative(i.e. a valid input signal will not have reached VIH/IL(ac) at the time of the rising clock transition) a valid input signal is still required to complete the transition and reach VIH/IL(ac). For slew rate in between the values listed in table x, the derating valued may obtained by linear interpolation. These values are typically not subject to production test. They are verified by design and characterization.

Fig. a. Illustration of nominal slew rate for t_{IS},t_{DS}

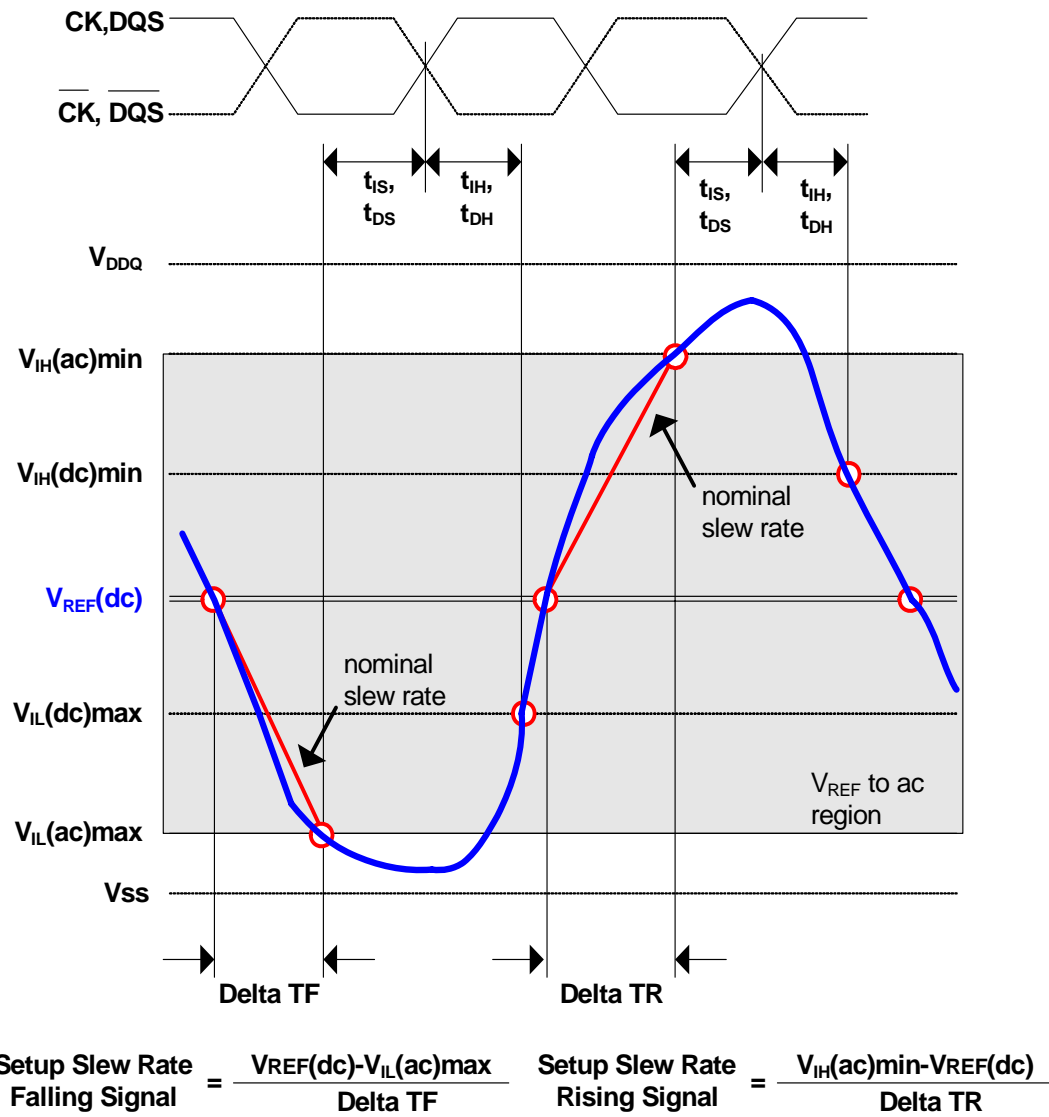
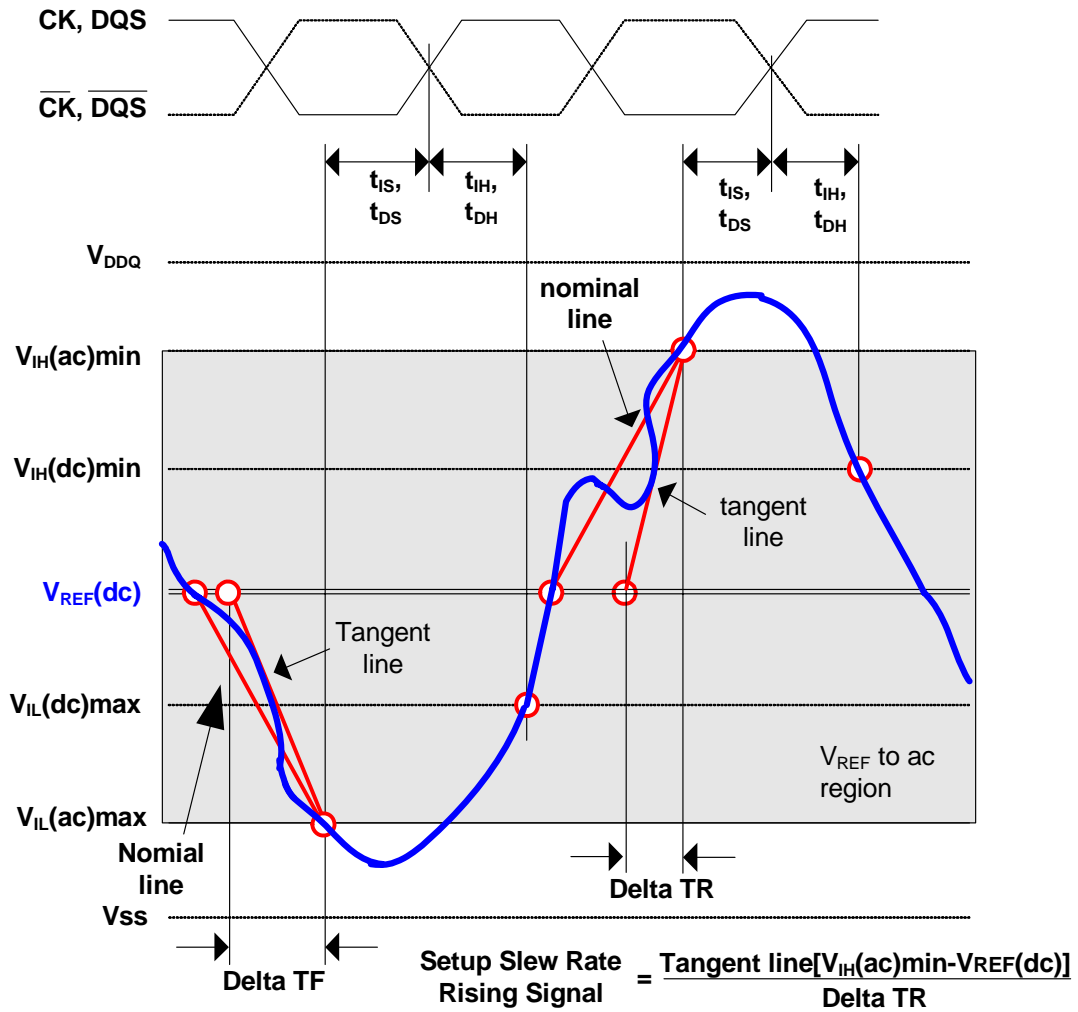

Fig. b. Illustration of tangent line for tIS,tDS



$$\text{Setup Slew Rate Falling Signal} = \frac{\text{Tangent line}[V_{REF(dc)}-V_{IL(ac)max}]}{\text{Delta TF}}$$

Fig. c. Illustration of nominal line for t_{IH} , t_{DH}

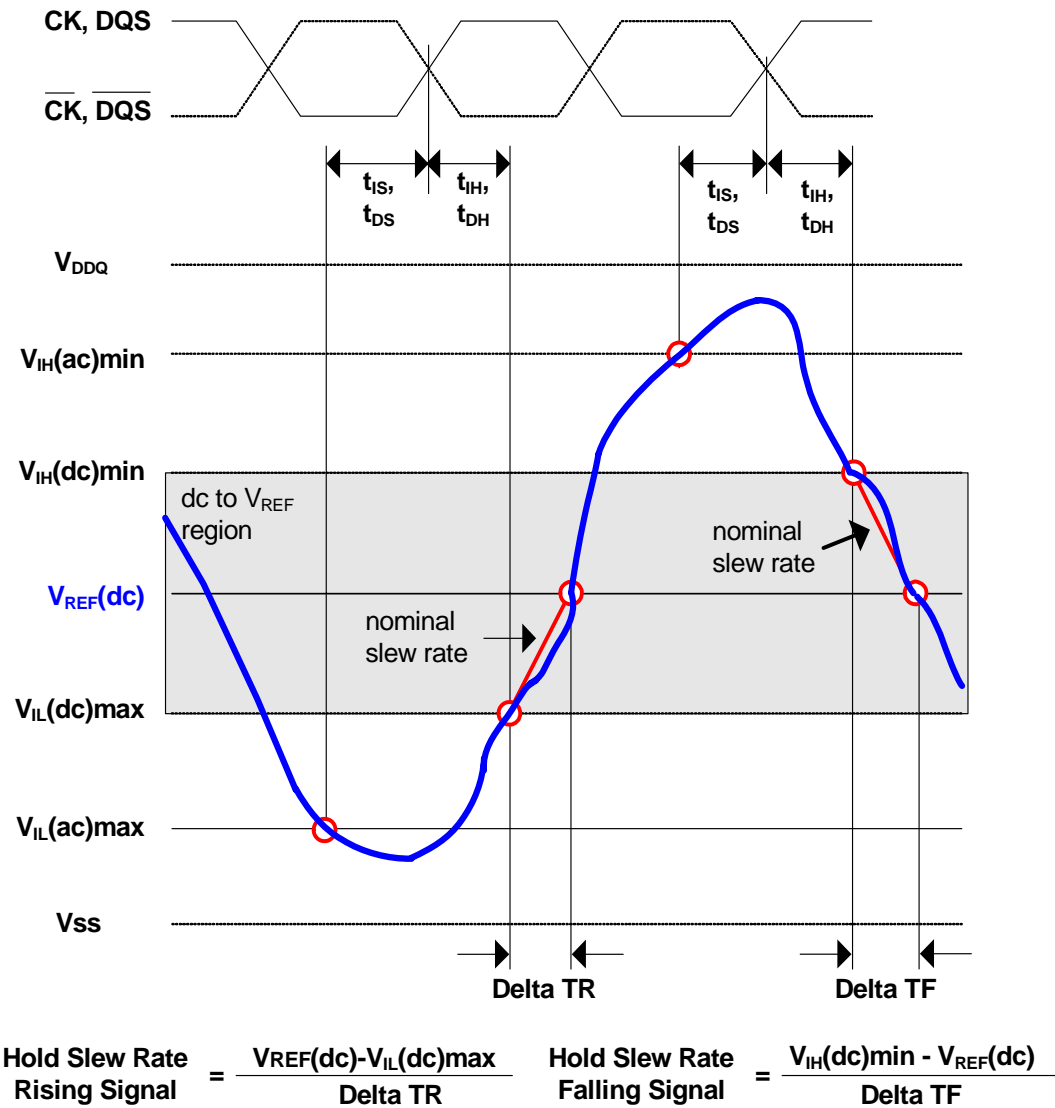
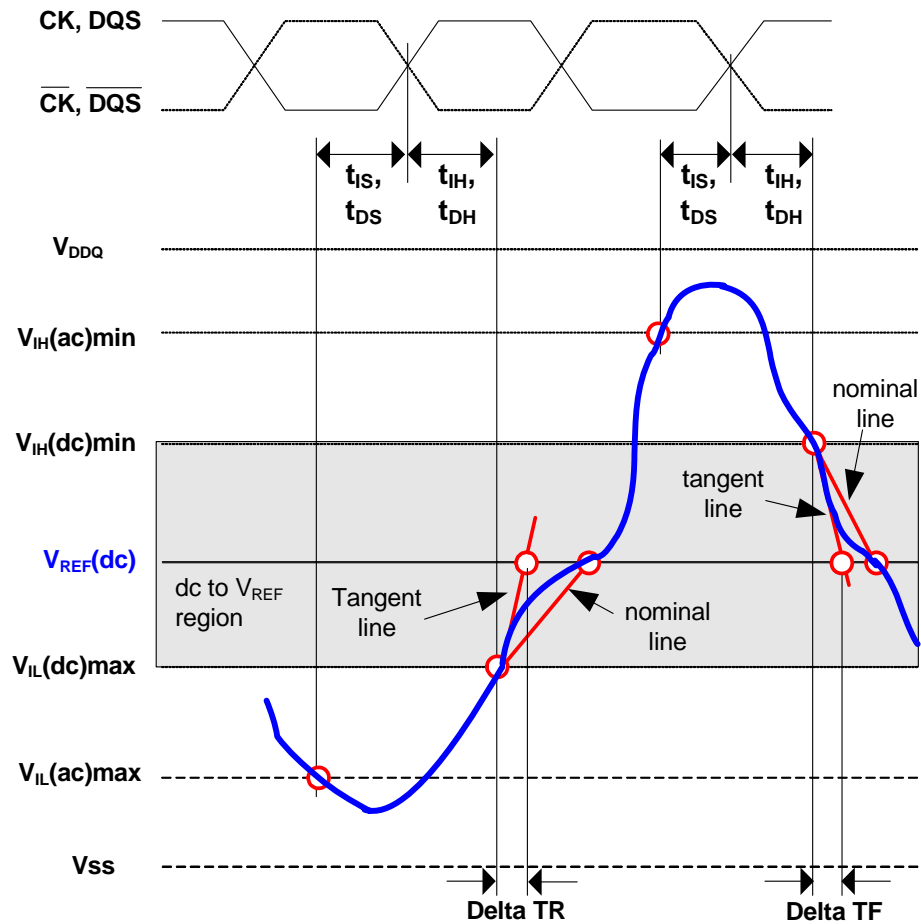

Fig. d. Illustration of tangent line for tIH , tDH



$$\text{Hold Slew Rate Rising Signal} = \frac{\text{Tangent line}[V_{REF}(dc) - V_{IL}(ac)max]}{\Delta TR}$$

$$\text{Hold Slew Rate Falling Signal} = \frac{\text{Tangent line}[V_{IH}(ac)min - V_{REF}(dc)]}{\Delta TF}$$

9. tIS and tIH (input setup and hold) derating

tIS, tIH Derating Values for DDR2-400, DDR2-533											
		CK, \overline{CK} Differential Slew Rate						Units		Notes	
		2.0 V/ns		1.5 V/ns		1.0 V/ns					
		Δ tIS	Δ tIH	Δ tIS	Δ tIH	Δ tIS	Δ tIH				
Command / Address Slew rate(V/ns)	4.0	+187	+94	+217	+124	+247	+154	ps	1		
	3.5	+179	+89	+209	+119	+239	+149	ps	1		
	3.0	+167	+83	+197	+113	+227	+143	ps	1		
	2.5	+150	+75	+180	+105	+210	+135	ps	1		
	2.0	+125	+45	+155	+75	+185	+105	ps	1		
	1.5	+83	+21	+113	+51	+143	+81	ps	1		
	1.0	+0	0	+30	+30	+60	+60	ps	1		
	0.9	-11	-14	+19	+16	+49	+46	ps	1		
	0.8	-25	-31	+5	-1	+35	+29	ps	1		
	0.7	-43	-54	-13	-24	+17	+6	ps	1		
	0.6	-67	-83	-37	-53	-7	-23	ps	1		
	0.5	-110	-125	-80	-95	-80	-65	ps	1		
	0.4	-175	-188	-145	-158	-115	-128	ps	1		
	0.3	-285	-292	-255	-262	-225	-232	ps	1		
	0.25	-350	-375	-320	-345	-290	-315	ps	1		
	0.2	-525	-500	-495	-470	-465	-440	ps	1		
0.15	-800	-708	-770	-678	-740	-648	ps	1			
0.1	-1450	-1125	-1420	-1095	-1390	-1065	ps	1			

tIS, tIH Derating Values for DDR2-667, DDR2-800											
		CK, \overline{CK} Differential Slew Rate						Units		Notes	
		2.0 V/ns		1.5 V/ns		1.0 V/ns					
		Δ tIS	Δ tIH	Δ tIS	Δ tIH	Δ tIS	Δ tIH				
Command / Address Slew rate(V/ns)	4.0	+15	+94	+180	+124	+210	+154	ps	1		
	3.5	+143	+89	+173	+119	+203	+149	ps	1		
	3.0	+133	+83	+163	+113	+193	+143	ps	1		
	2.5	+120	+75	+150	+105	+180	+135	ps	1		
	2.0	+100	+45	+130	+75	+150	+105	ps	1		
	1.5	+67	+21	+97	+51	+127	+81	ps	1		
	1.0	0	0	+30	+30	+60	+60	ps	1		
	0.9	-5	-14	+25	+16	+55	+46	ps	1		
	0.8	-13	-31	+17	-1	+47	+29	ps	1		
	0.7	-22	-54	+8	-24	+38	+6	ps	1		
	0.6	-34	-83	-4	-53	+26	-23	ps	1		
	0.5	-60	-125	-30	-95	0	-65	ps	1		
	0.4	-100	-188	-70	-158	-40	-128	ps	1		
	0.3	-168	-292	-138	-262	-108	-232	ps	1		
	0.25	-200	-375	-170	-345	-140	-315	ps	1		
	0.2	-325	-500	-395	-470	-265	-440	ps	1		
0.15	-517	-708	-487	-678	-457	-648	ps	1			
0.1	-1000	-1125	-970	-1095	-940	-1065	ps	1			

1) For all input signals the total tIS(setup time) and tIH(hold) time) required is calculated by adding the datasheet value to the derating value listed in above Table.

Setup(tIS) nominal slew rate for a rising signal is defined as the slew rate between the last crossing of $V_{REF}(dc)$ and the first crossing of $V_{IH}(ac)_{min}$. Setup(tIS) nominal slew rate for a falling signal is defined as the slew rate between the last crossing of $V_{REF}(dc)$ and the first crossing of $V_{IL}(ac)_{max}$. If the actual signal is always earlier than the nominal slew rate for line between shaded ' $V_{REF}(dc)$ to ac region', use nominal slew rate for derating value(see fig a.) If the actual signal is later than the nominal slew rate line anywhere between shaded ' $V_{REF}(dc)$ to ac region', the slew rate of a tangent line to the actual signal from the ac level to dc level is used for derating value(see Fig b.)

Hold(tIH) nominal slew rate for a rising signal is defined as the slew rate between the last crossing of $V_{IL}(dc)_{max}$ and the first crossing of $V_{REF}(dc)$. Hold(tIH) nominal slew rate for a falling signal is defined as the slew rate between the last crossing of $V_{REF}(dc)$. If the actual signal is always later than the nominal slew rate line between shaded ' dc to $V_{REF}(dc)$ region', use nominal slew rate for derating value(see Fig.c) If the actual signal is earlier than the nominal slew rate line anywhere between shaded ' dc to $V_{REF}(dc)$ region', the slew rate of a tangent line to the actual signal from the dc level to $V_{REF}(dc)$ level is used for derating value(see Fig d.)

Although for slow rates the total setup time might be negative(i.e. a valid input signal will not have reached $V_{IH/IL}(ac)$ at the time of the rising clock transition) a valid input signal is still required to complete the transition and reach $V_{IH/IL}(ac)$.

For slew rates in between the values listed in table, the derating values may obtained by linear interpolation.

These values are typically not subject to production test. They are verified by design and characterization.

10. The maximum limit for this parameter is not a device limit. The device will operate with a greater value for this parameter, but system performance (bus turnaround) will degrade accordingly.

11. MIN (t CL, t CH) refers to the smaller of the actual clock LOW time and the actual clock HIGH time as provided to the device (i.e. this value can be greater than the minimum specification limits for t CL and t CH). For example, t CL and t CH are = 50% of the period, less the half period jitter (t JIT(HP)) of the clock source, and less the half period jitter due to crosstalk (t JIT(crosstalk)) into the clock traces.

12. $t_{OH} = t_{HP} - t_{QHS}$, where:

tHP = minimum half clock period for any given cycle and is defined by clock HIGH or clock LOW (tCH,tCL).
tQHS accounts for:

- 1) The pulse duration distortion of on-chip clock circuits; and
- 2) The worst case push-out of DQS on one transition followed by the worst case pull-in of DQ on the next transition, both of which are, separately, due to data pin skew and output pattern effects, and p-channel to n-channel variation of the output drivers.

13. tDQSQ: Consists of data pin skew and output pattern effects, and p-channel to n-channel variation of the output drivers as well as output slew rate mismatch between DQS/ \overline{DQS} and associated DQ in any given cycle.

14. $t_{DAL} = (nWR) + (t_{RP}/t_{CK})$:

For each of the terms above, if not already an integer, round to the next highest integer. tCK refers to the application clock period. nWR refers to the t WR parameter stored in the MR.

Example: For DDR533 at t CK = 3.75 ns with t WR programmed to 4 clocks. $t_{DAL} = 4 + (15 \text{ ns} / 3.75 \text{ ns})$
clocks = 4 + (4)clocks=8clocks.

15. The clock frequency is allowed to change during self-refresh mode or precharge power-down mode.

In case of clock frequency change during precharge power-down, a specific procedure is required as described in section 2.9.

16. ODT turn on time min is when the device leaves high impedance and ODT resistance begins to turn on.

ODT turn on time max is when the ODT resistance is fully on. Both are measured from tAOND.

17. ODT turn off time min is when the device starts to turn off ODT resistance.

ODT turn off time max is when the bus is in high impedance. Both are measured from tAOFD.

18. tHZ and tLZ transitions occur in the same access time as valid data transitions. These parameters are referenced to a specific voltage level which specifies when the device output is no longer driving (tHZ), or begins driving (tLZ). Below figure shows a method to calculate the point when device is no longer driving (tHZ), or begins driving (tLZ) by measuring the signal at two different voltages. The actual voltage measurement points are not critical as long as the calculation is consistent.

19. tRPST end point and tRPRE begin point are not referenced to a specific voltage level but specify when the device output is no longer driving (tRPST), or begins driving (tRPRE). Below figure shows a method to calculate these points when the device is no longer driving (tRPST), or begins driving (tRPRE). Below Figure shows a method to calculate these points when the device is no longer driving (tRPST), or begins driving (tRPRE) by measuring the signal at two different voltages. The actual voltage measurement points are not critical as long as the calculation is consistent.

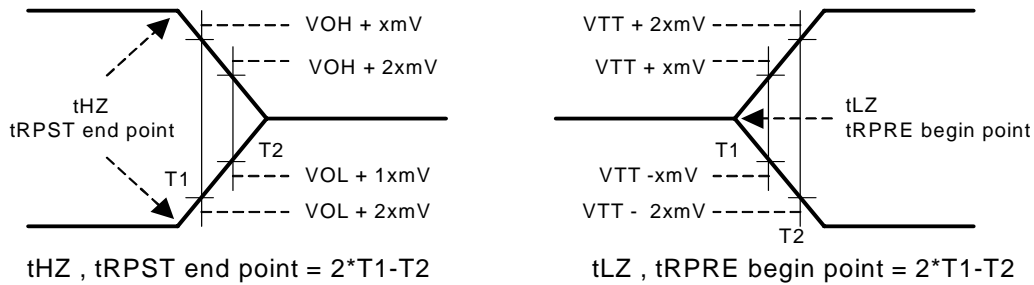

20. Input waveform timing with differential data strobe enabled MR[bit10] = 0, is referenced from the input signal crossing at the $V_{IH}(ac)$ level to the differential data strobe crosspoint for a rising signal, and from the input signal crossing at the $V_{IL}(ac)$ level to the differential data strobe crosspoint for a falling signal applied to the device under test.

21. Input waveform timing with differential data strobe enabled MR[bit10]=0, is referenced from the input signal crossing at the $V_{IH}(dc)$ level to the differential data strobe crosspoint for a rising signal and $V_{IL}(dc)$ to the differential data strobe crosspoint for a falling signal applied to the device under test.

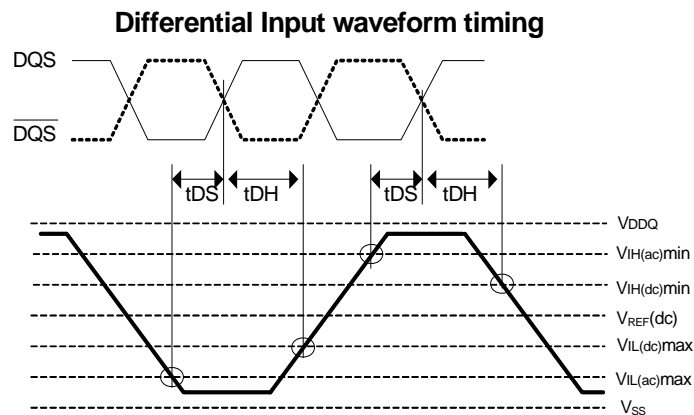

22. Input waveform timing is referenced from the input signal crossing at the $V_{IH}(ac)$ level for a rising signal and $V_{IL}(ac)$ for a falling signal applied to the device under test.
23. Input waveform timing is referenced from the input signal crossing at the $V_{IL}(dc)$ level for a rising signal and $V_{IH}(dc)$ for a falling signal applied to the device under test.
24. tWTR is at least two clocks ($2 \times tCK$ or $2 \times nCK$) independent of operation frequency.
25. Input waveform timing with single-ended data strobe enabled $MR[bit10] = 1$, is referenced from the input signal crossing at the $V_{IH}(ac)$ level to the single-ended data strobe crossing $V_{IH}/L(dc)$ at the start of its transition for a rising signal, and from the input signal crossing at the $V_{IL}(ac)$ level to the single-ended data strobe crossing $V_{IH}/L(dc)$ at the start of its transition for a falling signal applied to the device under test. The DQS signal must be monotonic between $V_{il}(dc)_{max}$ and $V_{ih}(dc)_{min}$.
26. Input waveform timing with single-ended data strobe enabled $MR[bit10] = 1$, is referenced from the input signal crossing at the $V_{IH}(dc)$ level to the single-ended data strobe crossing $V_{IH}/L(ac)$ at the end of its transition for a rising signal, and from the input signal crossing at the $V_{IL}(dc)$ level to the single-ended data strobe crossing $V_{IH}/L(ac)$ at the end of its transition for a falling signal applied to the device under test. The DQS signal must be monotonic between $V_{il}(dc)_{max}$ and $V_{ih}(dc)_{min}$.
27. tCKE_{min} of 3 clocks means CKE must be registered on three consecutive positive clock edges. CKE must remain at the valid input level the entire time it takes to achieve the 3 clocks of registration. Thus, after any CKE transition, CKE may not transition from its valid level during the time period of $tIS + 2 \times tCK + tIH$.
28. If tDS or tDH is violated, data corruption may occur and the data must be re-written with valid data before a valid READ can be executed.
29. These parameters are measured from a command/address signal (CKE, CS, RAS, CAS, WE, ODT, BA0, A0, A1, etc.) transition edge to its respective clock signal (CK/CK) crossing. The spec values are not affected by the amount of clock jitter applied (i.e. tJIT(per), tJIT(cc), etc.), as the setup and hold are relative to the clock signal crossing that latches the command/address. That is, these parameters should be met whether clock jitter is present or not.
30. These parameters are measured from a data strobe signal ((L/U/R)DQS/DQS) crossing to its respective clock signal (CK/CK) crossing. The spec values are not affected by the amount of clock jitter applied (i.e. tJIT(per), tJIT(cc), etc.), as these are relative to the clock signal crossing. That is, these parameters should be met whether clock jitter is present or not.
31. These parameters are measured from a data signal ((L/U) DM, (L/U) DQ0, (L/U) DQ1, etc.) transition edge to its respective data strobe signal ((L/U/R)DQS/DQS) crossing.
32. For these parameters, the DDR2 SDRAM device is characterized and verified to support $tnPARAM = RU\{tPARAM / tCK(avg)\}$, which is in clock cycles, assuming all input clock jitter specifications

are satisfied.

For example, the device will support $t_{nRP} = RU \{t_{RP} / t_{CK}(avg)\}$, which is in clock cycles, if all input clock jitter specifications are met. This means: For DDR2-667 5-5-5, of which $t_{RP} = 15ns$, the device will support $t_{nRP} = RU\{t_{RP} / t_{CK}(avg)\} = 5$, i.e. as long as the input clock jitter specifications are met, Precharge command at T_m and Active command at T_m+5 is valid even if $(T_m+5 - T_m)$ is less than 15ns due to input clock jitter.

33. $t_{DAL} [nCK] = WR [nCK] + t_{nRP} [nCK] = WR + RU \{t_{RP} [ps] / t_{CK}(avg) [ps] \}$, where WR is the value programmed in the mode register set.

34. New units, 'tCK(avg)' and 'nCK', are introduced in DDR2-667 and DDR2-800.

Unit 'tCK(avg)' represents the actual tCK(avg) of the input clock under operation.

Unit 'nCK', represents one clock cycle of the input clock, counting the actual clock edges.

Note that in DDR2-400 and DDR2-533, 'tCK', is used for both concepts.

ex) $t_{XP} = 2 [nCK]$ means; if Power Down exit is registered at T_m , an Active command may be registered at T_m+2 , even if $(T_m+2 - T_m)$ is $2 \times t_{CK}(avg) + t_{ERR}(2per),min$.

35. Input clock jitter spec parameter. These parameters and the ones in the table below are referred to as 'input clock jitter spec parameters' and these parameters apply to DDR2-667 and DDR2-800 only. The jitter specified is a random jitter meeting a Gaussian distribution.

Parameter	Symbol	DDR2-667		DDR2-800		Units	Notes
		min	max	min	max		
Clock period jitter	tJIT(per)	-125	125	-100	100	ps	35
Clock period jitter during DLL locking period	tJIT(per,lck)	-100	100	-80	80	ps	35
Cycle to cycle clock period jitter	tJIT(cc)	-250	250	-200	200	ps	35
Cycle to cycle clock period jitter during DLL locking period	tJIT(cc,lck)	-200	200	-160	160	ps	35
Cumulative error across 2 cycles	tERR(2per)	-175	175	-150	150	ps	35
Cumulative error across 3 cycles	tERR(3per)	-225	225	-175	175	ps	35
Cumulative error across 4 cycles	tERR(4per)	-250	250	-200	200	ps	35
Cumulative error across 5 cycles	tERR(5per)	-250	250	-200	200	ps	35
Cumulative error across n cycles, n=6...10, inclusive	tERR(6~10per)	-350	350	-300	300	ps	35
Cumulative error across n cycles, n=11...50, inclusive	tERR(11~50per)	-450	450	-450	450	ps	35
Duty cycle jitter	tJIT(duty)	-125	125	-100	100	ps	35

36. These parameters are specified per their average values, however it is understood that the following relationship between the average timing and the absolute instantaneous timing holds at all times. (Min and max of SPEC values are to be used for calculations in the table below.)

Parameter	Symbol	min	max	Units
Absolute clock period	tCK(abs)	tCK(avg),min+tJIT(per),min	tCK(avg),max+tJIT(per),max	ps
Absolute clock HIGH pulse width	tCH(abs)	tCH(avg),min*tCK(avg),min+tJIT(per),min	tCH(avg),max*tCK(avg),max+tJIT(per),max	ps
Absolute clock LOW pulse width	tCL(abs)	tCL(avg),min*tCK(avg),min+tJIT(per),min	tCL(avg),max*tCK(avg),max+tJIT(per),max	ps

Example: For DDR2-667, tCH(abs),min = (0.48 x 3000 ps) - 125 ps = 1315 ps

37. tHP is the minimum of the absolute half period of the actual input clock. tHP is an input parameter but not an input specification parameter. It is used in conjunction with tQHS to derive the DRAM output timing tQH.

The value to be used for tQH calculation is determined by the following equation;

$$tHP = \text{Min} (tCH(\text{abs}), tCL(\text{abs})),$$

where,

tCH(abs) is the minimum of the actual instantaneous clock HIGH time;

tCL(abs) is the minimum of the actual instantaneous clock LOW time;

38. tQHS accounts for:

- 1) The pulse duration distortion of on-chip clock circuits, which represents how well the actual tHP at the input is transferred to the output; and
- 2) The worst case push-out of DQS on one transition followed by the worst case pull-in of DQ on the next transition, both of which are independent of each other, due to data pin skew, output pattern effects, and p-channel to n-channel variation of the output drivers

39. tQH = tHP ? tQHS, where:

tHP is the minimum of the absolute half period of the actual input clock; and

tQHS is the specification value under the max column.

{The less half-pulse width distortion present, the larger the tQH value is; and the larger the valid data eye will be.}

Examples:

- 1) If the system provides tHP of 1315 ps into a DDR2-667 SDRAM, the DRAM provides tQH of 975 ps minimum.
- 2) If the system provides tHP of 1420 ps into a DDR2-667 SDRAM, the DRAM provides tQH of 1080 ps minimum.

40. When the device is operated with input clock jitter, this parameter needs to be derated by the actual tERR(6-10per) of the input clock. (output deratings are relative to the SDRAM input clock.)

For example, if the measured jitter into a DDR2-667 SDRAM has tERR(6-10per),min = - 272 ps and tERR(6-10per), max = + 293 ps, then tDQSK,min(derated) = tDQSK,min - tERR(6-10per),max = - 400 ps - 293 ps = - 693 ps and tDQSK,max(derated) = tDQSK,max - tERR(6-10per),min = 400 ps + 272 ps

= + 672 ps. Similarly, tLZ(DQ) for DDR2-667 derates to tLZ(DQ),min(derated) = - 900 ps - 293 ps = - 1193 ps and tLZ(DQ),max(derated) = 450 ps + 272 ps = + 722 ps. (Caution on the min/max usage!)

41. When the device is operated with input clock jitter, this parameter needs to be derated by the actual tJIT(per) of the input clock. (output deratings are relative to the SDRAM input clock.)

For example, if the measured jitter into a DDR2-667 SDRAM has tJIT(per),min = - 72 ps and tJIT(per),max = + 93 ps, then tRPRE,min(derated) = tRPRE,min + tJIT(per),min = 0.9 x tCK(avg) - 72 ps = + 2178 ps and tRPRE,max(derated) = tRPRE,max + tJIT(per),max = 1.1 x tCK(avg) + 93 ps = + 2843 ps. (Caution on the min/max usage!)

42. When the device is operated with input clock jitter, this parameter needs to be derated by the actual tJIT(duty) of the input clock. (output deratings are relative to the SDRAM input clock.)

For example, if the measured jitter into a DDR2-667 SDRAM has tJIT(duty),min = - 72 ps and tJIT(duty),max = + 93 ps, then tRPST,min(derated) = tRPST,min + tJIT(duty),min = 0.4 x tCK(avg) - 72 ps = + 928 ps and tRPST,max(derated) = tRPST,max + tJIT(duty),max = 0.6 x tCK(avg) + 93 ps = + 1592 ps. (Caution on the min/max usage!)

43. When the device is operated with input clock jitter, this parameter needs to be derated by { - tJIT(duty),max - tERR(6-10per),max } and { - tJIT(duty),min - tERR(6-10per),min } of the actual input clock. (output deratings are relative to the SDRAM input clock.)

For example, if the measured jitter into a DDR2-667 SDRAM has tERR(6-10per),min = - 272 ps, tERR(6-10per),max = + 293 ps, tJIT(duty),min = - 106 ps and tJIT(duty),max = + 94 ps, then tAOF,min(derated) = tAOF,min + { - tJIT(duty),max - tERR(6-10per),max } = - 450 ps + { - 94 ps - 293 ps } = - 837 ps and tAOF,max(derated) = tAOF,max + { - tJIT(duty),min - tERR(6-10per),min } = 1050 ps + { 106 ps + 272 ps } = + 1428 ps. (Caution on the min/max usage!)

44. For tAOFD of DDR2-400/533, the 1/2 clock of tCK in the 2.5 x tCK assumes a tCH, input clock HIGH pulse width of 0.5 relative to tCK. tAOF,min and tAOF,max should each be derated by the same amount as the actual amount of tCH offset present at the DRAM input with respect to 0.5. For example, if an input clock has a worst case tCH of 0.45, the tAOF,min should be derated by subtracting 0.05 x tCK from it, whereas if an input clock has a worst case tCH of 0.55, the tAOF,max should be derated by adding 0.05 x tCK to it. Therefore, we have;

$$tAOF,min(derated) = tAC,min - [0.5 - \text{Min}(0.5, tCH,min)] \times tCK$$

$$tAOF,max(derated) = tAC,max + 0.6 + [\text{Max}(0.5, tCH,max) - 0.5] \times tCK$$

or

$$tAOF,min(derated) = \text{Min}(tAC,min, tAC,min - [0.5 - tCH,min] \times tCK)$$

$$tAOF,max(derated) = 0.6 + \text{Max}(tAC,max, tAC,max + [tCH,max - 0.5] \times tCK)$$

where tCH,min and tCH,max are the minimum and maximum of tCH actually measured at the DRAM input balls.

45. For tAOFD of DDR2-667/800, the 1/2 clock of nCK in the 2.5 x nCK assumes a tCH(avg), average input clock HIGH pulse width of 0.5 relative to tCK(avg). tAOF,min and tAOF,max should each be derated by the same amount as the actual amount of tCH(avg) offset present at the DRAM input with respect to 0.5. For example, if an input clock has a worst case tCH(avg) of 0.48, the tAOF,min should be derated by subtracting 0.02 x tCK(avg) from it, whereas if an input clock has a worst case tCH(avg) of 0.52, the tAOF,max

should be derated by adding $0.02 \times tCK(\text{avg})$ to it. Therefore, we have;

$$tAOF, \text{min}(\text{derated}) = tAC, \text{min} - [0.5 - \text{Min}(0.5, tCH(\text{avg}), \text{min})] \times tCK(\text{avg})$$

$$tAOF, \text{max}(\text{derated}) = tAC, \text{max} + 0.6 + [\text{Max}(0.5, tCH(\text{avg}), \text{max}) - 0.5] \times tCK(\text{avg})$$

or

$$tAOF, \text{min}(\text{derated}) = \text{Min}(tAC, \text{min}, tAC, \text{min} - [0.5 - tCH(\text{avg}), \text{min}] \times tCK(\text{avg}))$$

$$tAOF, \text{max}(\text{derated}) = 0.6 + \text{Max}(tAC, \text{max}, tAC, \text{max} + [tCH(\text{avg}), \text{max} - 0.5] \times tCK(\text{avg}))$$

where $tCH(\text{avg}), \text{min}$ and $tCH(\text{avg}), \text{max}$ are the minimum and maximum of $tCH(\text{avg})$ actually measured at the DRAM input balls.

Note that these deratings are in addition to the tAOF derating per input clock jitter, i.e. $tJIT(\text{duty})$ and $tERR(6-10\text{per})$. However tAC values used in the equations shown above are from the timing parameter table and are not derated. Thus the final derated values for tAOF are;

$$tAOF, \text{min}(\text{derated_final}) = tAOF, \text{min}(\text{derated}) + \{ - tJIT(\text{duty}), \text{max} - tERR(6-10\text{per}), \text{max} \}$$

$$tAOF, \text{max}(\text{derated_final}) = tAOF, \text{max}(\text{derated}) + \{ - tJIT(\text{duty}), \text{min} - tERR(6-10\text{per}), \text{min} \}$$

5. Package Dimensions

Package Dimension(x4,x8)

60Ball Fine Pitch Ball Grid Array Outline

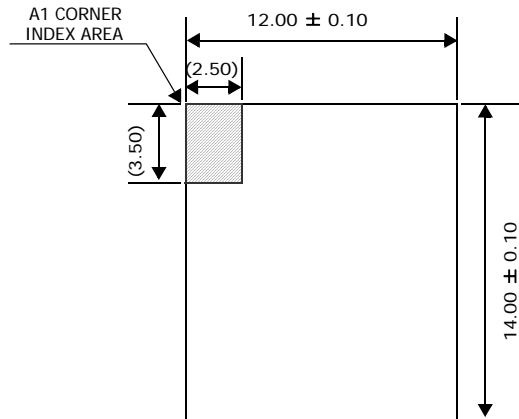

<Top View>

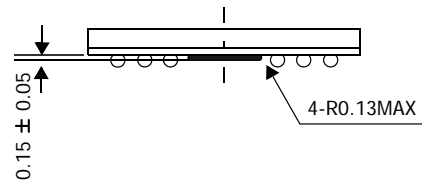

<SIDE View>

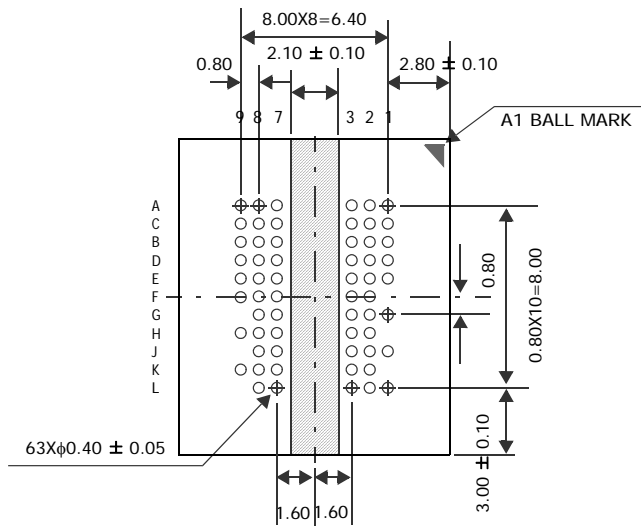

<BALL View>

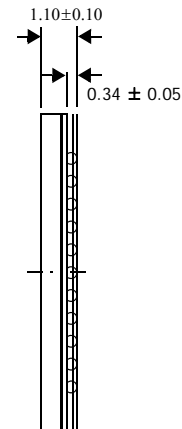

Note: All Dimensions are in millimeters.