

HSMS-285Y

Zero Bias Schottky Detector Diodes In Surface Mount SOD-523 Package



Data Sheet

Description/Applications

The HSMS-285Y of Avago Technologies is a zero bias Schottky detector diodes that designed and optimized for use in small signal ($P_{in} < -20$ dBm) applications at frequencies below 1.5 GHz. It is ideal for RF/ID and RF Tag applications where primary (DC bias) power is not available.

The device is housed in a miniature low cost surface mount SOD-523 package. This miniature package is particularly useful in the application where board space is the major concern.

Table 1. Absolute Maximum Ratings ^[1] at $T_c = +25^\circ\text{C}$

Symbol	Parameter	Unit	Max Rating
P_{IV}	Peak Inverse Voltage	V	2.0
T_J	Junction Temperature	$^\circ\text{C}$	150
T_{STG}	Storage Temperature	$^\circ\text{C}$	-65 to 150
T_{OP}	Operating Temperature	$^\circ\text{C}$	-65 to 150
θ_{jb}	Thermal Resistance ^[2]	$^\circ\text{C}/\text{W}$	175

Notes:

1. Operation in excess of any one of these conditions may result in permanent damage to the device.
2. Thermal Resistance is measured from junction to board using IR method.

Features

- Space saving SOD-523 package
- High Detection Sensitivity :
- Up to 50mV/uW at 915 MHz
- Low Flicker Noise :
-162 dBV/Hz at 100 Hz
- Tape and Reel Options Available
- MSL 1 & Lead Free

Package Marking and Pin Connections



Note: Package marking provides orientation and identification
"R" = Device Code
"?" = Month code indicates the month of manufacture



Attention: Observe precautions for handling electrostatic sensitive devices.

ESD Machine Model <30V

ESD Human Body Model =200 V

Refer to Avago Technologies Application Note A004R: *Electrostatic Discharge, Damage and Control.*

Table 2. Electrical Specifications at Tc = +25°C

	Maximum Forward Voltage VF (mV)		Maximum Reverse Leakage IR (uA)	Typical Capacitance CT (pF)
	150	250	175	0.30
Test Conditions	IF = 0.1 mA	IF = 1.0 mA	VR = 2V	VR = -0.5 V to -1.0 V f = 1MHz

Table 3. RF Electrical Specifications, Tc = +25°C

	Typical Tangential Sensitivity TSS (dBm) @ f = 915 MHz	Typical Voltage Sensitivity γ (mV/ μ W) @ f = 915 MHz	Typical Video Resistance RV (K Ω)
	-57	40	8.0
Test Conditions	Video Bandwidth = 2 MHz Zero Bias	Power in = -40 dBm RL = 100 K Ω , Zero Bias	Zero Bias

Typical Parameters

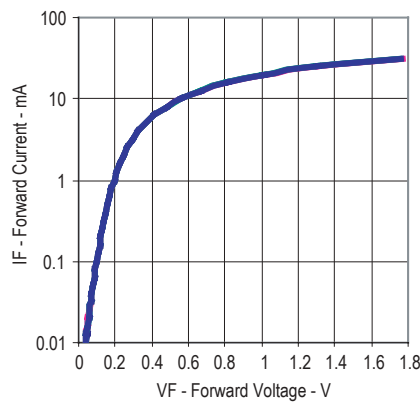

Figure 1. Typical Forward Current vs Forward Voltage.

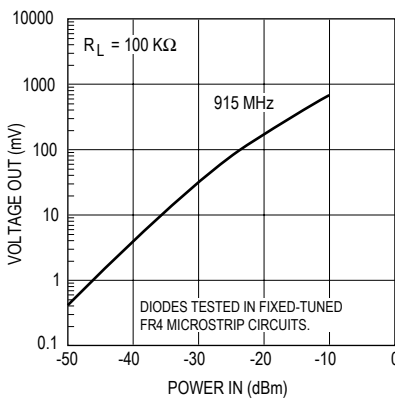

Figure 2. 25°C Output Voltage vs Input Power at Zero Bias.

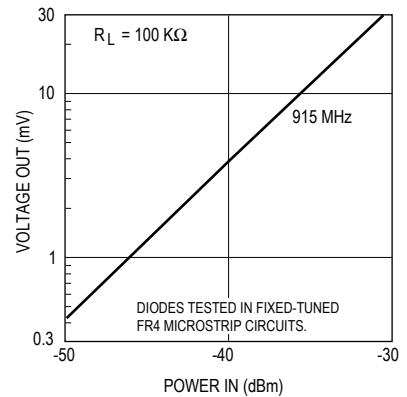

Figure 3. 25°C Expanded Output Voltage vs Input Power. See Figure 2.

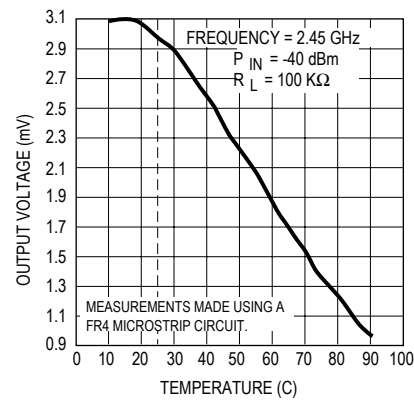
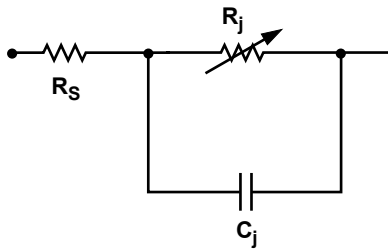

Figure 4. Output Voltage vs Temperature.

Equivalent Linear Circuit Model

HSMS-285x chip



R_S = series resistance (see Table of SPICE parameters)

C_j = junction capacitance (see Table of SPICE parameters)

$$R_j = \frac{8.33 \times 10^{-5} \text{ nT}}{I_b + I_s}$$

where

I_b = externally applied bias current in amps

I_s = saturation current (see table of SPICE parameters)

T = temperature, K

n = ideality factor (see table of SPICE parameters)

Note:

To effectively model the packaged HSMS-285x product, please refer to Application Note AN1124.

SPICE Parameters

Parameter	Units	HSMS-285x
B_V	V	3.8
C_{J0}	pF	0.18
E_G	eV	0.69
I_{BV}	A	3E -4
I_S	A	3E -6
N		1.06
R_S	Ω	25
$P_B (V_J)$	V	0.35
$P_T (XTI)$		2
M		0.5

Package Outline and Dimension

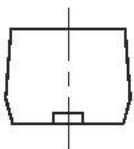
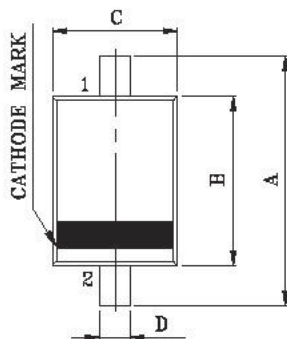

DIM	MILLIMETERS
A	1.60±0.10
B	1.20±0.10
C	0.80±0.10
D	0.30±0.05
E	0.60±0.10
F	0.13±0.05

PCB Footprint

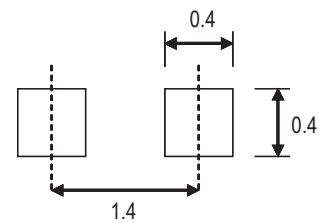

Unit : mm

Device Orientation

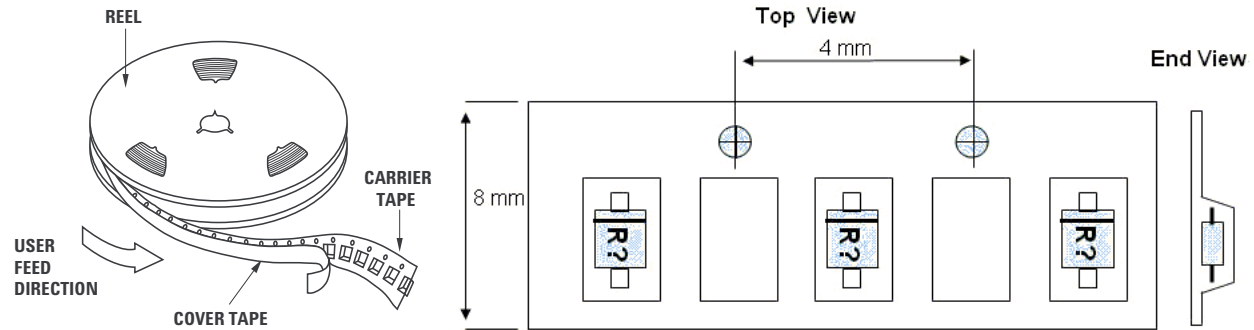

Tape Dimensions

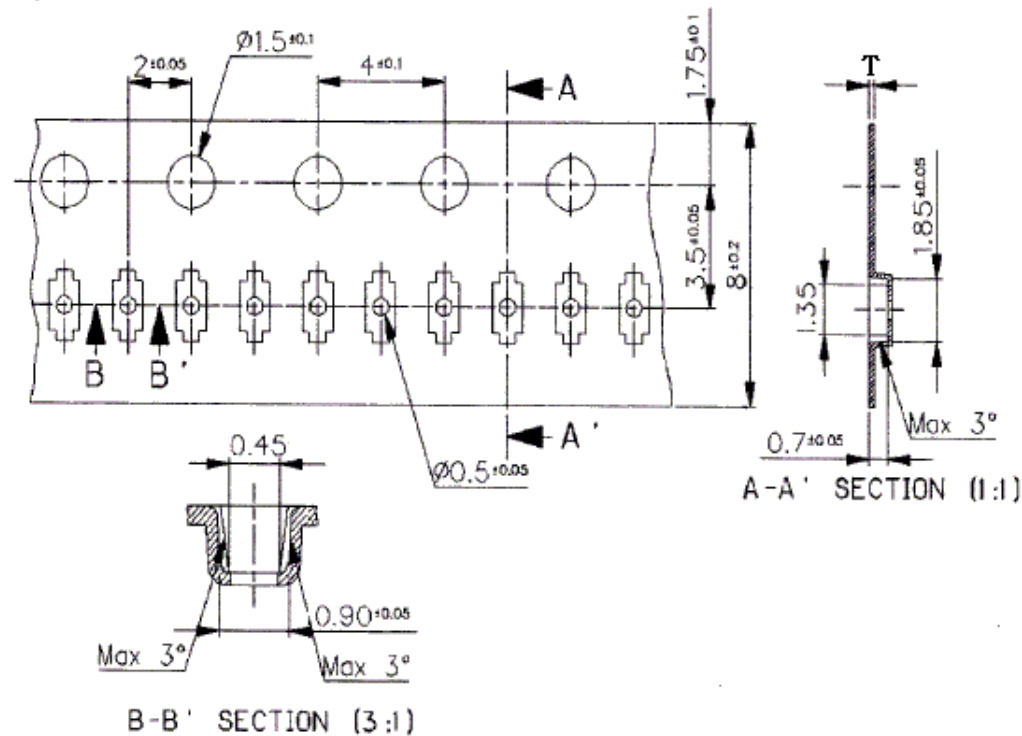

Specification < Unit : mm >

hole pitch : 50 Pitch Tolerance : 200 ± 0.3

General Tolerance : ± 0.1

Surface resistance : $104 \sim 108 \Omega$

Part Number Ordering Information

Part number	No. of Units	Container
HSMS-285Y-BLKG	100	Anti-static bag
HSMS-285Y-TR1G	3000	7" reel

For product information and a complete list of distributors, please go to our web site: www.avagotech.com

Avago, Avago Technologies, and the A logo are trademarks of Avago Technologies, Limited in the United States and other countries. Data subject to change. Copyright © 2006 Avago Technologies Limited. All rights reserved. Obsoletes AV01-0117EN AV01-0690EN - December 21, 2006

AVAGO
TECHNOLOGIES