

Multilayer Chip Baluns For DCS/Tx & Rx

Conformity to RoHS Directive

HHM Series HHM1748G1

SHAPES AND DIMENSIONS

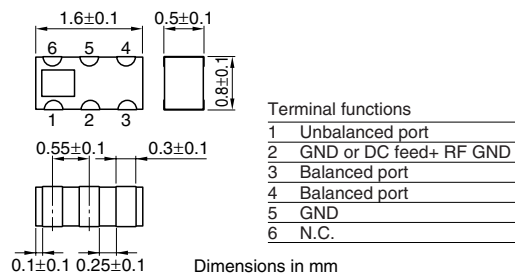

CIRCUIT DIAGRAM

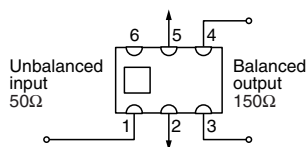

RECOMMENDED PC BOARD PATTERNS

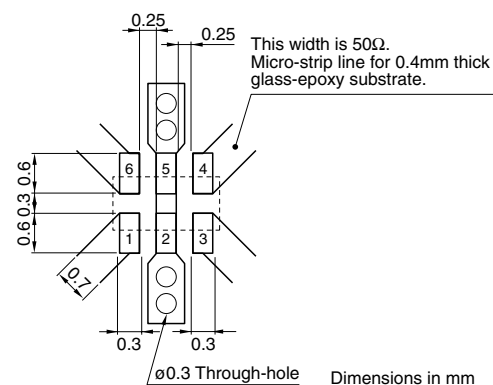

ELECTRICAL CHARACTERISTICS

Unbalanced impedance	50Ω	
Balanced impedance	150Ω	
Frequency range	1710 to 1880MHz	
Unbalanced port return loss	10dB min.	
Phase imbalance at balanced port	180±10deg.	
Amplitude imbalance at balanced port	0±1.5dB	
Insertion loss	1.0dB max.	
Temperature range	Operating	-40 to +85°C
	Storage	-40 to +85°C
Packaging style and quantities	4000pieces/reel	

- Conformity to RoHS Directive: This means that, in conformity with EU Directive 2002/95/EC, lead, cadmium, mercury, hexavalent chromium, and specific bromine-based flame retardants, PBB and PBDE, have not been used, except for exempted applications.

- All specifications are subject to change without notice.

FREQUENCY CHARACTERISTICS

Unbalance 50Ω/Balance 150Ω

RETURN LOSS

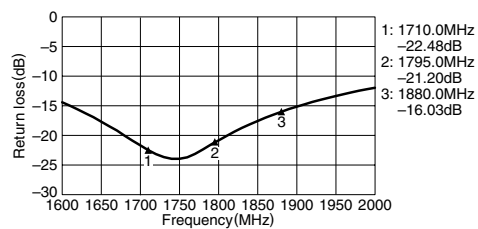

AMPLITUDE BALANCE

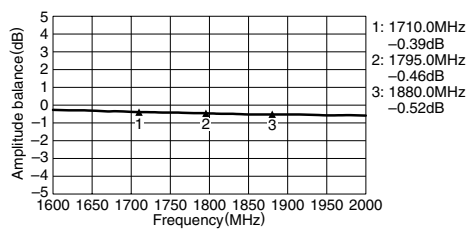

INSERTION LOSS

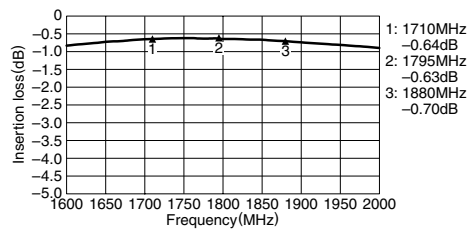

PHASE BALANCE

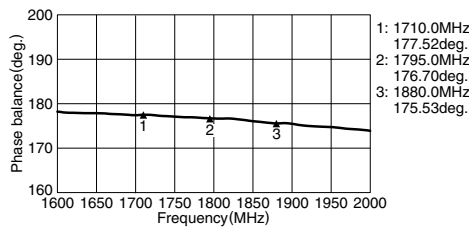

• All specifications are subject to change without notice.