

# Multilayer Chip Baluns For Bluetooth & 2.4GHz W-LAN

Conformity to RoHS Directive

HHM Series HHM1712D1

## SHAPES AND DIMENSIONS

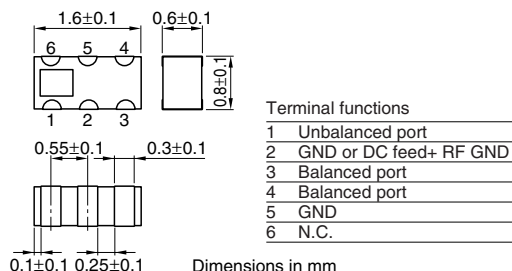

## CIRCUIT DIAGRAM

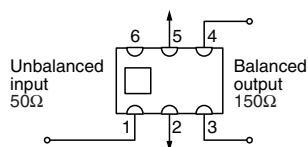

## RECOMMENDED PC BOARD PATTERNS

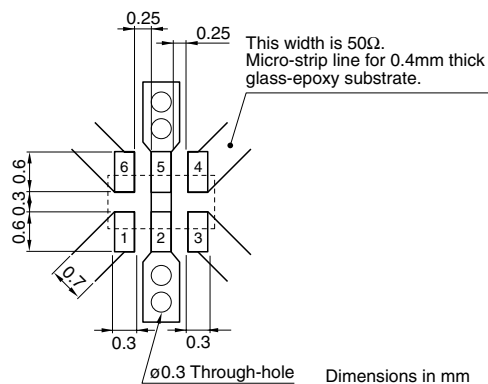

## ELECTRICAL CHARACTERISTICS

Unbalanced impedance	50Ω	
Balanced impedance	150Ω	
Frequency range	2400 to 2500MHz	
Unbalanced port return loss	10dB min.	
Phase imbalance at balanced port	180±10deg	
Amplitude imbalance at balanced port	0±2.0dB	
Insertion loss	1.2dB max.	
Temperature range	Operating	-40 to +85°C
	Storage	-40 to +85°C
Packaging style and quantities	4000pieces/reel	

- Conformity to RoHS Directive: This means that, in conformity with EU Directive 2002/95/EC, lead, cadmium, mercury, hexavalent chromium, and specific bromine-based flame retardants, PBB and PBDE, have not been used, except for exempted applications.

- All specifications are subject to change without notice.

### FREQUENCY CHARACTERISTICS

Unbalance 50Ω/Balance 150Ω

#### RETURN LOSS

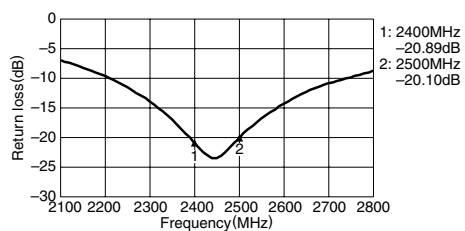

#### AMPLITUDE BALANCE

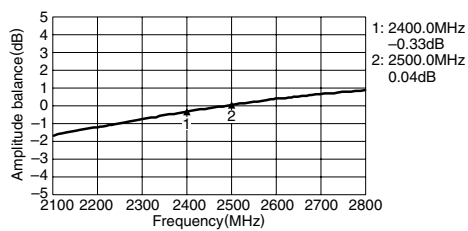

#### INSERTION LOSS

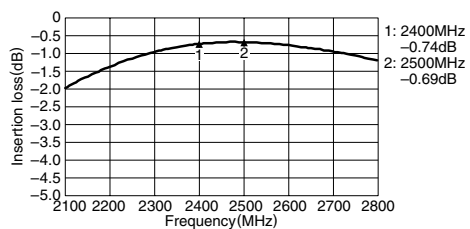

#### PHASE BALANCE

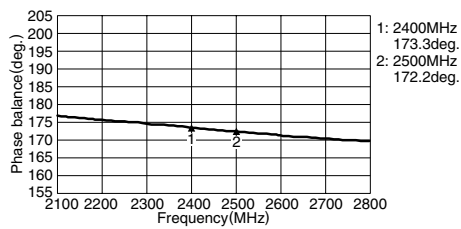

• All specifications are subject to change without notice.