

# HMC511LP5 / 511LP5E

## MMIC VCO w/ HALF FREQUENCY OUTPUT 9.05 - 10.15 GHz

### Typical Applications

Low noise MMIC VCO w/Half Frequency, for:

- VSAT Radio
- Point to Point/Multi-Point Radio
- Test Equipment & Industrial Controls
- Military End-Use

### Features

Dual Output:  $F_o = 9.05 - 10.15$  GHz

$F_o/2 = 4.525 - 5.075$  GHz

Pout: +13 dBm

Phase Noise: -115 dBc/Hz @100 kHz Typ.

No External Resonator Needed

QFN Leadless SMT Package, 25 mm<sup>2</sup>

### Functional Diagram

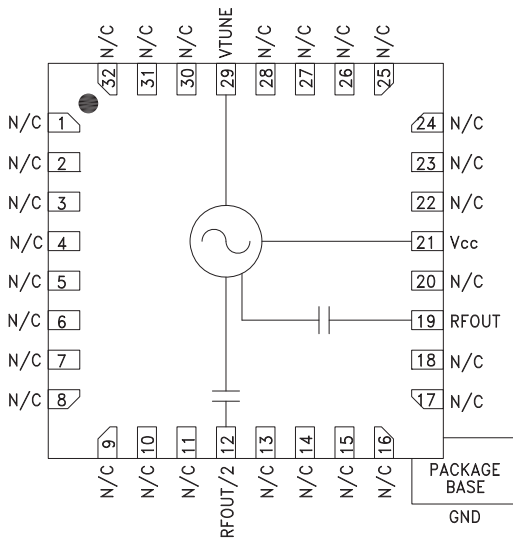

### General Description

The HMC511LP5 & HMC511LP5E are GaAs InGaP Heterojunction Bipolar Transistor (HBT) MMIC VCOs. The HMC511LP5 & HMC511LP5E integrate resonators, negative resistance devices, varactor diodes and feature a half frequency output. The VCO's phase noise performance is excellent over temperature, shock, and process due to the oscillator's monolithic structure. Power output is +13 dBm typical from a +5V supply. The voltage controlled oscillator is packaged in a leadless QFN 5x5 mm surface mount package, and requires no external matching components.

### Electrical Specifications, $T_A = +25^\circ\text{C}$ , $V_{cc} = +5V$

| Parameter  | Min. | Typ.          | Max. | Units  |
|--|------|---------------|------|--------|
| Frequency Range  |      | 9.05 - 10.15  |      | GHz    |
|  |      | 4.525 - 5.075 |      | GHz    |
| Power Output   | +9   |               | +16  | dBm    |
|  | +5   |               | +11  | dBm    |
| SSB Phase Noise @ 100 kHz Offset, $V_{tune} = +5V$ @ RFOUT |      | -115          |      | dBc/Hz |
| Tune Voltage   | 2    |               | 13   | V      |
| Supply Current (I <sub>cc</sub> ) ( $V_{cc} = +5.0V$ )     | 200  | 265           | 300  | mA     |
| Tune Port Leakage Current ( $V_{tune} = 13V$ )             |      |               | 10   | μA     |
| Output Return Loss   |      | 2             |      | dB     |
| Harmonics/Subharmonics                                     |      |               |      |        |
|  | 1/2  | 38            |      | dBc    |
|  | 2nd  | 15            |      | dBc    |
|  | 3rd  | 30            |      | dBc    |
| Pulling (into a 2.0:1 VSWR)                                |      | 8             |      | MHz pp |
| Pushing @ $V_{tune} = 5V$                                  |      | 15            |      | MHz/V  |
| Frequency Drift Rate                                       |      | 0.9           |      | MHz/°C |

For price, delivery, and to place orders, please contact Hittite Microwave Corporation:  
20 Alpha Road, Chelmsford, MA 01824 Phone: 978-250-3343 Fax: 978-250-3373  
Order On-line at [www.hittite.com](http://www.hittite.com)



# HMC511LP5 / 511LP5E

## MMIC VCO w/ HALF FREQUENCY OUTPUT 9.05 - 10.15 GHz

**Frequency vs. Tuning Voltage, T= 25°C**

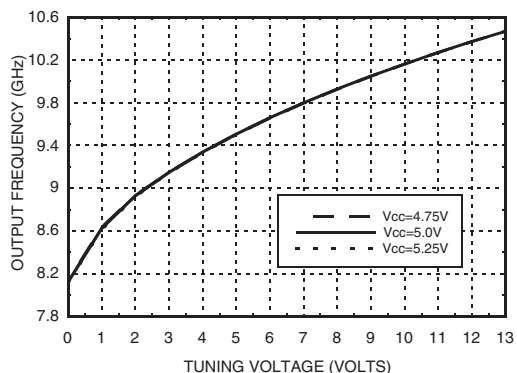

**Frequency vs. Tuning Voltage, Vcc= +5V**

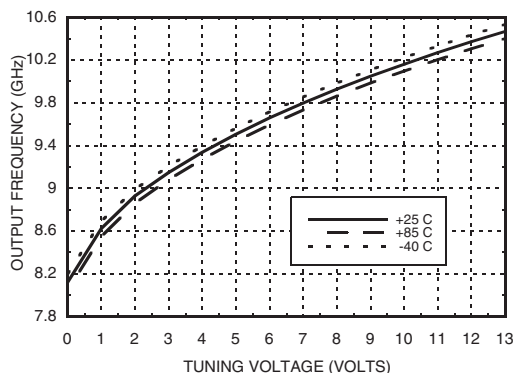

**Sensitivity vs. Tuning Voltage, Vcc= +5V**

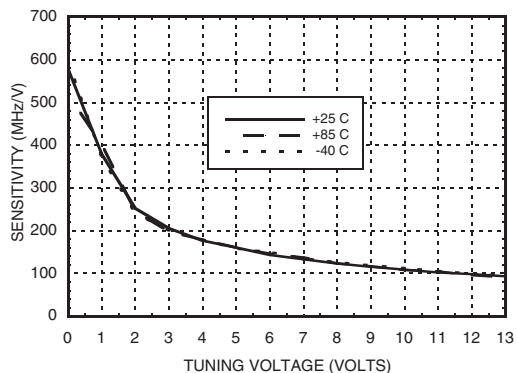

**Output Power vs. Tuning Voltage, Vcc= +5V**

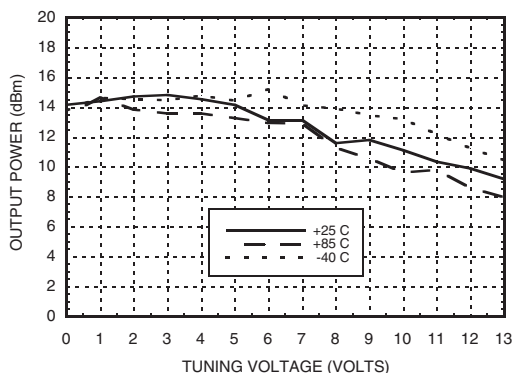

**SSB Phase Noise vs. Tuning Voltage**

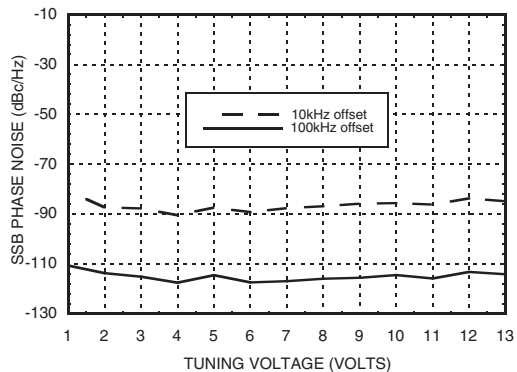

**SSB Phase Noise @ Vtune = +5V**

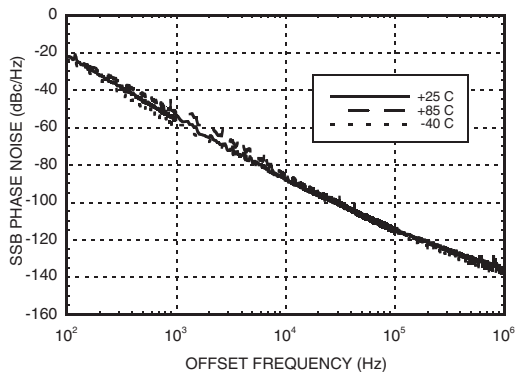

For price, delivery, and to place orders, please contact Hittite Microwave Corporation:  
20 Alpha Road, Chelmsford, MA 01824 Phone: 978-250-3343 Fax: 978-250-3373  
Order On-line at [www.hittite.com](http://www.hittite.com)

# HMC511LP5 / 511LP5E

## MMIC VCO w/ HALF FREQUENCY OUTPUT 9.05 - 10.15 GHz

**RFOUT/2 Frequency  
vs. Tuning Voltage, Vcc= +5V**

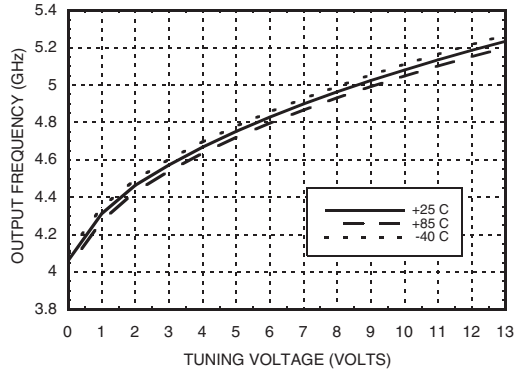

**RFOUT/2 Output Power  
vs. Tuning Voltage, Vcc= +5V**

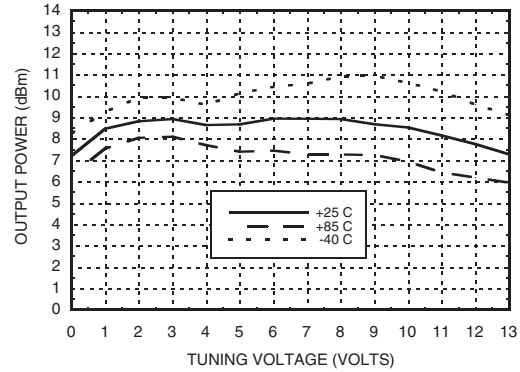

### Absolute Maximum Ratings

|  |                |
|--|----------------|
| Vcc  | +5.5 Vdc       |
| Vtune  | 0 to +15V      |
| Junction Temperature   | 135 °C         |
| Continuous P <sub>diss</sub> (T=85 °C)<br>(derate 31.5 mW/C above 85 °C) | 1.58 W         |
| Thermal Resistance<br>(junction to ground paddle)                        | 31.6 °C/W      |
| Storage Temperature  | -65 to +150 °C |
| Operating Temperature  | -40 to +85 °C  |
| ESD Sensitivity (HBM)  | Class 1A       |

### Typical Supply Current vs. Vcc

| Vcc (V) | I <sub>cc</sub> (mA) |
|---------|----------------------|
| 4.75    | 245                  |
| 5.0     | 265                  |
| 5.25    | 285                  |

Note: VCO will operate over full voltage range shown above.



**ELECTROSTATIC SENSITIVE DEVICE  
OBSERVE HANDLING PRECAUTIONS**

### Outline Drawing

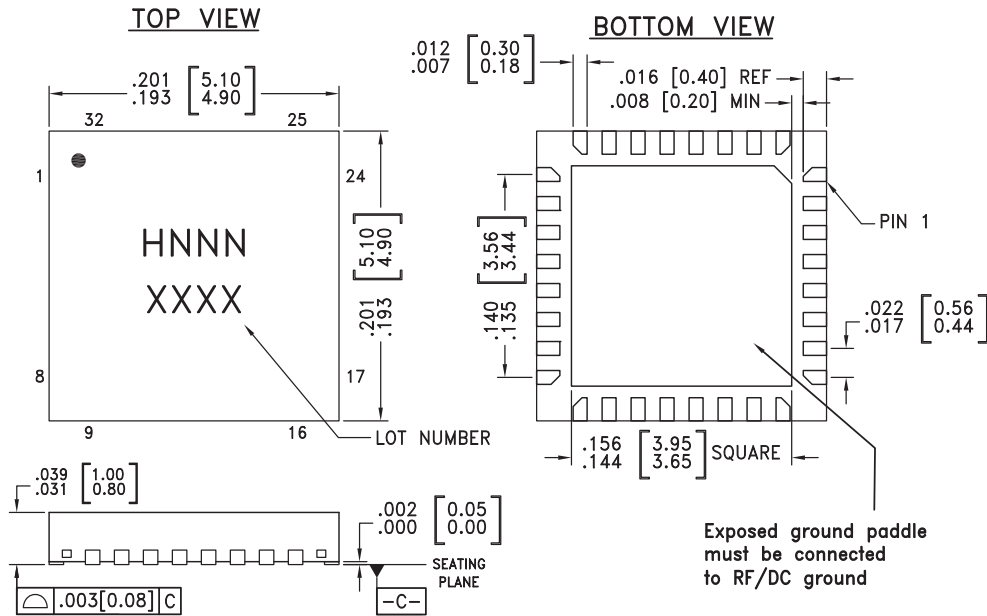

**NOTES:**

1. LEADFRAME MATERIAL: COPPER ALLOY
2. DIMENSIONS ARE IN INCHES [MILLIMETERS]
3. LEAD SPACING TOLERANCE IS NON-CUMULATIVE.
4. PAD BURR LENGTH SHALL BE 0.15mm MAXIMUM.  
PAD BURR HEIGHT SHALL BE 0.05mm MAXIMUM.
5. PACKAGE WARP SHALL NOT EXCEED 0.05mm.
6. ALL GROUND LEADS AND GROUND PADDLE MUST BE SOLDERED TO PCB RF GROUND.
7. REFER TO HITTITE APPLICATION NOTE FOR SUGGESTED LAND PATTERN.

### Package Information

| Part Number | Package Body Material                               | Lead Finish   | MSL Rating          | Package Marking <sup>[3]</sup> |
|-------------|---|---------------|---------------------|--------------------------------|
| HMC511LP5   | Low Stress Injection Molding Plastic                | Sn/Pb Solder  | MSL1 <sup>[1]</sup> | H511<br>XXXX                   |
| HMC511LP5E  | RoHS-compliant Low Stress Injection Molding Plastic | 100% matte Sn | MSL1 <sup>[2]</sup> | H511<br>XXXX                   |



[1] Max peak reflow temperature of 235 °C

[2] Max peak reflow temperature of 260 °C

[3] 4-Digit lot number XXXX

For price, delivery, and to place orders, please contact Hittite Microwave Corporation:  
20 Alpha Road, Chelmsford, MA 01824 Phone: 978-250-3343 Fax: 978-250-3373  
Order On-line at [www.hittite.com](http://www.hittite.com)

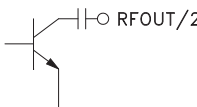
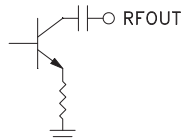
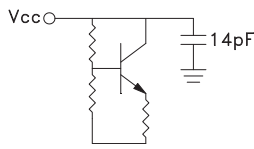
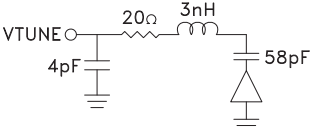
### Pin Descriptions

| Pin Number                    | Function | Description   | Interface Schematic   |
|-------------------------------|----------|---|---|
| 1-11, 13-18, 20, 22-28, 30-32 | N/C      | No Connection. These pins may be connected to RF/DC ground. Performance will not be affected. |   |
| 12                            | RFOUT/2  | Half frequency output (AC coupled).   |    |
| 19                            | RFOUT    | RF output (AC coupled).   |    |
| 21                            | Vcc      | Supply Voltage, +5V   |   |
| 29                            | VTUNE    | Control Voltage Input. Modulation port bandwidth dependent on drive source impedance.         |  |
|                               | GND      | Package bottom has an exposed metal paddle that must be connected to RF/DC ground.            |  |

**Evaluation PCB**

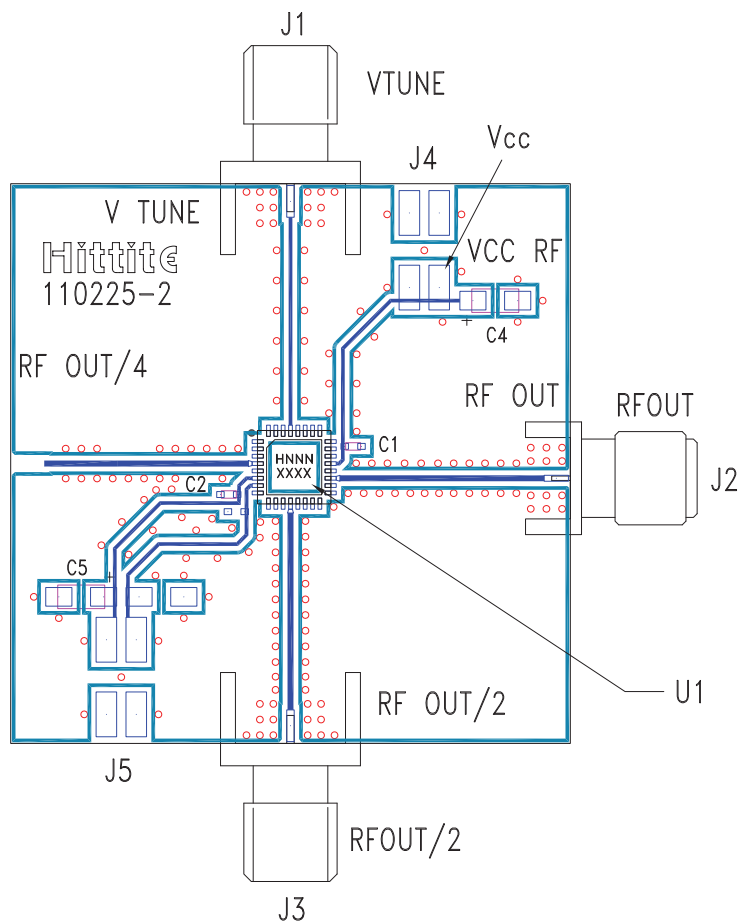

**List of Materials for Evaluation PCB 110227 [1]**

| Item    | Description                    |
|---------|--------------------------------|
| J1 - J3 | PCB Mount SMA RF Connector     |
| J4, J5  | 2 mm DC Header                 |
| C1 - C2 | 100 pF Capacitor, 0402 Pkg.    |
| C4 - C5 | 2.2 $\mu$ F Tantalum Capacitor |
| U1      | HMC511LP5 / HMC511LP5E VCO     |
| PCB [2] | 110225 Eval Board              |

[1] Reference this number when ordering complete evaluation PCB

[2] Circuit Board Material: Rogers 4350

The circuit board used in the final application should use RF circuit design techniques. Signal lines should have 50 ohm impedance while the package ground leads and backside ground paddle should be connected directly to the ground plane similar to that shown. A sufficient number of via holes should be used to connect the top and bottom ground planes. The evaluation circuit board shown is available from Hittite upon request.