

Typical Applications

The HMC599ST89(E) is ideal for:

- CATV, Cable Modem & DBS
- Cellular / PCS / 3G
- Fixed Wireless & WLAN
- Microwave Radio & Test Equipment
- IF & RF Applications

Functional Diagram

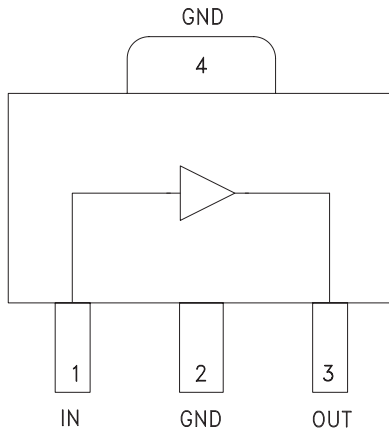

Features

- High P1dB Output Power: +19 dBm
- High Output IP3: +39 dBm
- Low Noise Figure: 2.2 dB
- Cascadable 75 Ohm I/Os
- Single Bias Supply: +3V or +5V
- Industry Standard SOT89 Package

General Description

The HMC599ST89(E) is a GaAs PHEMT High Linearity, Low Noise Gain Block MMIC SMT amplifier covering 50 to 960 MHz. Packaged in an industry standard SOT89, the amplifier can be used as a cascadable 75 Ohm RF or IF gain stage as well as a PA or LO driver with up to +19 dBm output power. The HMC599ST89(E) offers 14 dB of gain with a +39 dBm output IP3 at 250 MHz, and can operate directly from a +3V or +5V supply. The HMC599ST89(E) exhibits excellent gain and output power stability over temperature, while requiring a minimal number of external bias components.

Electrical Specifications, $V_{dd} = 5V$, $T_A = +25^\circ C$

Parameter		Min.	Typ.	Max.	Units
Gain	50 - 500 MHz	13	14.5		dB
	500 - 960 MHz	12	14		dB
Gain Variation Over Temperature	50 - 960 MHz		0.005		dB/ °C
Input Return Loss	50 - 500 MHz		15		dB
	500 - 960 MHz		12		dB
Output Return Loss	50 - 500 MHz		25		dB
	500 - 960 MHz		15		dB
Reverse Isolation	50 - 960 MHz		20		dB
Output Power for 1 dB Compression (P1dB)	50 - 500 MHz	16	19		dBm
Output Third Order Intercept (IP3) (Pout= -10 dBm per tone, 1 MHz spacing)	50 - 500 MHz		39		dBm
	500 - 960 MHz		36		dBm
Noise Figure	50 - 960 MHz		2.2		dB
Supply Current (I _{dd})		100	120	140	mA



Broadband Gain & Return Loss @ 3V

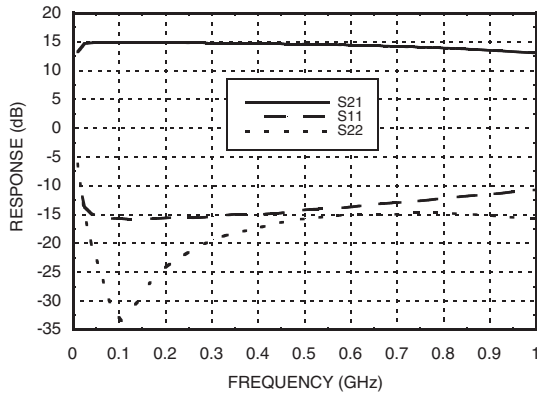

Broadband Gain & Return Loss @ 5V

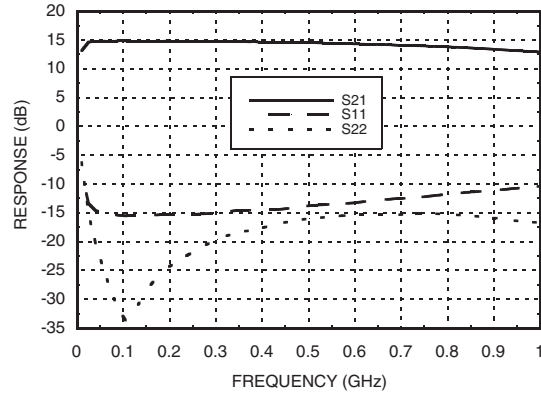

Gain vs. Temperature @ 3V

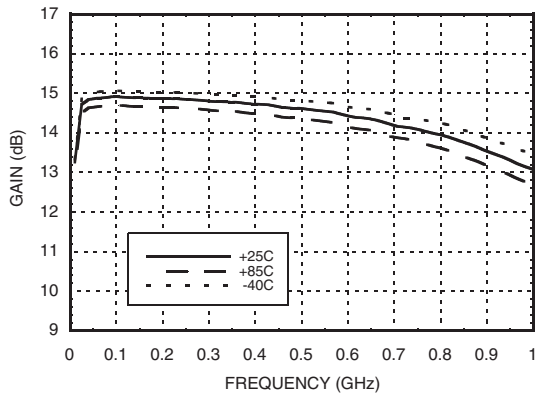

Gain vs. Temperature @ 5V

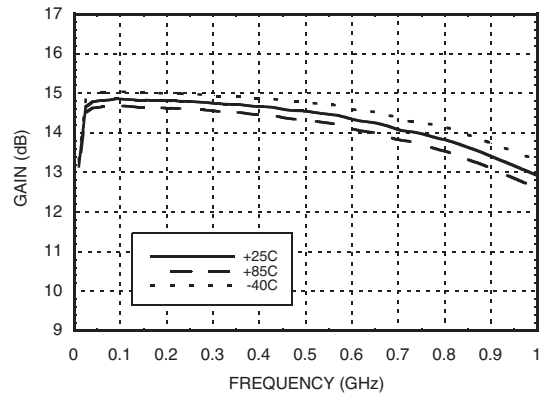

Input Return Loss vs. Temperature @ 3V

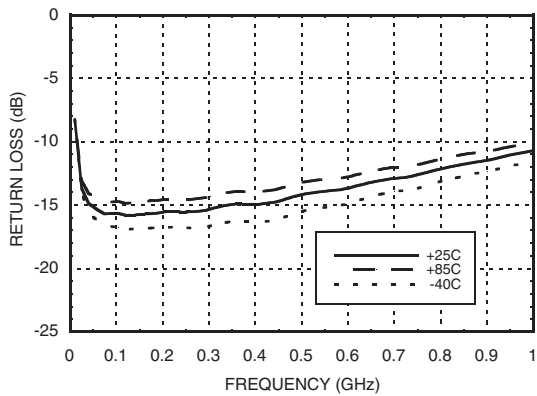

Input Return Loss vs. Temperature @ 5V

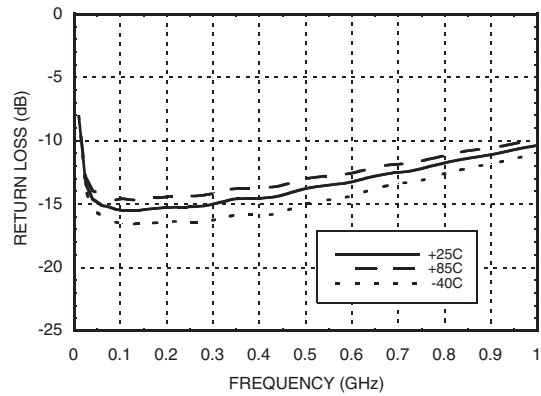

For price, delivery, and to place orders, please contact Hittite Microwave Corporation:
20 Alpha Road, Chelmsford, MA 01824 Phone: 978-250-3343 Fax: 978-250-3373
Order On-line at www.hittite.com

Output Return Loss vs. Temperature @ 3V

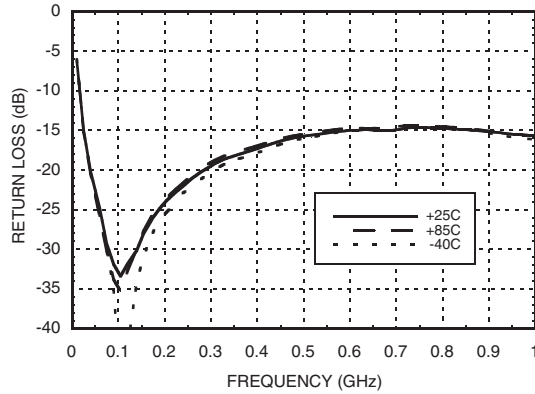

Output Return Loss vs. Temperature @ 5V

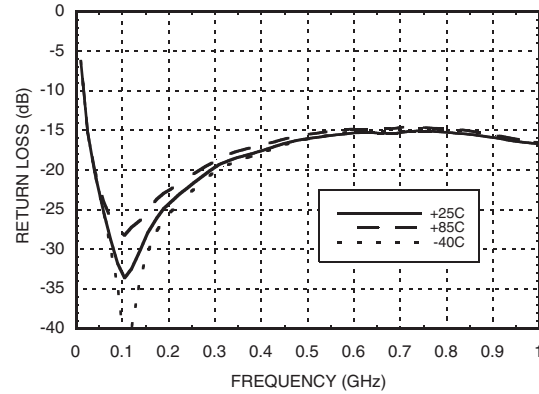

Reverse Isolation vs. Temperature @ 3V

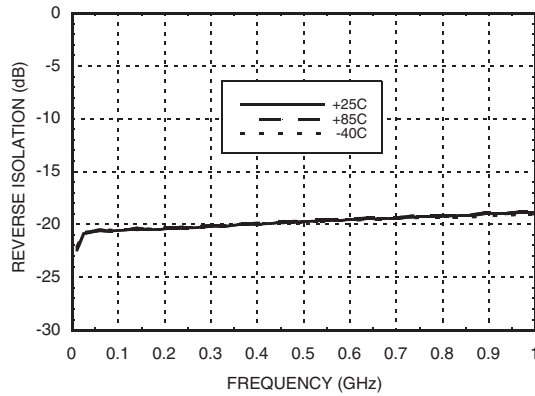

Reverse Isolation vs. Temperature @ 5V

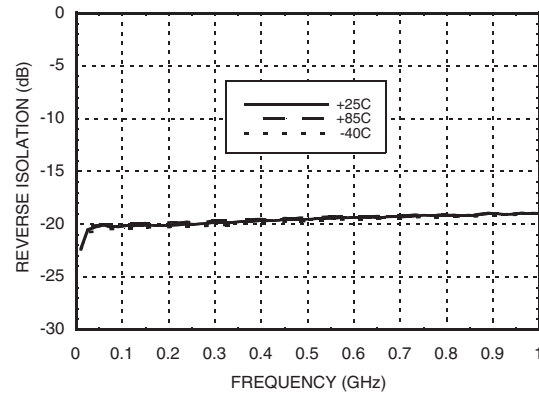

Noise Figure vs. Temperature @ 3V

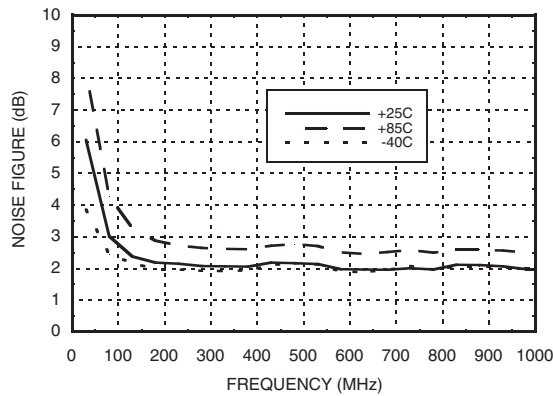

Noise Figure vs. Temperature @ 5V

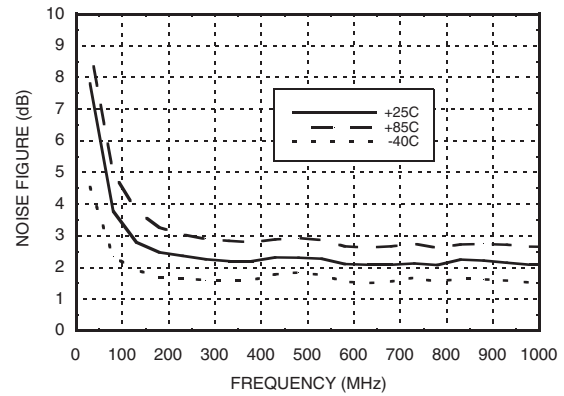



IP3 vs. Temperature @ 3V

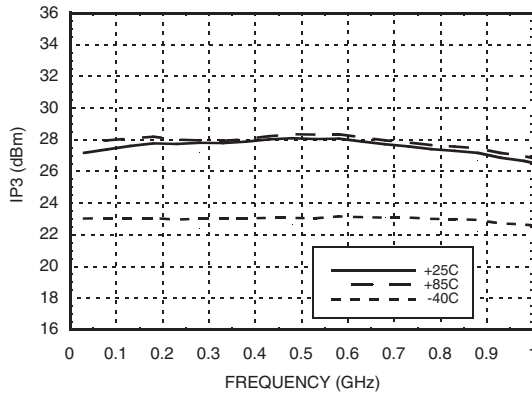

IP3 vs. Temperature @ 5V

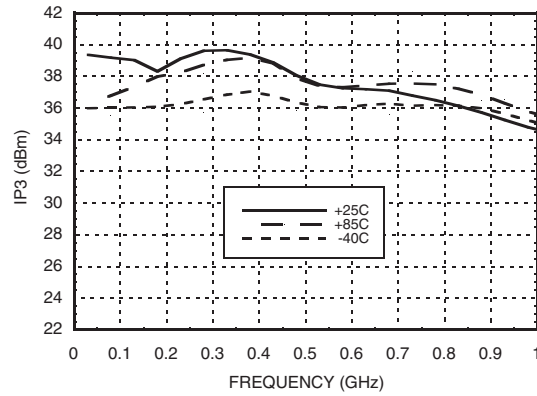

P1dB vs. Temperature @ 3V

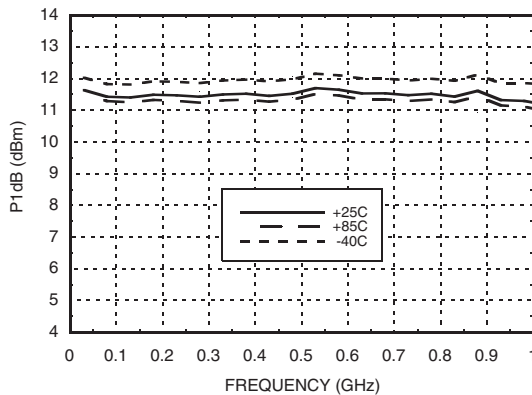

P1dB vs. Temperature @ 5V

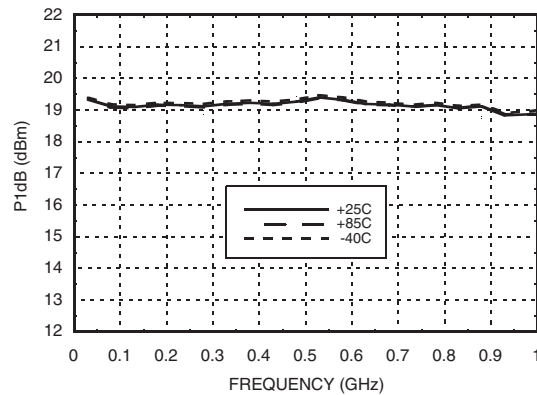

Psat vs. Temperature @ 3V

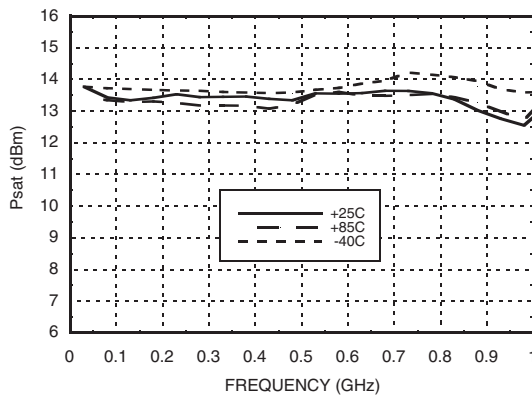

Psat vs. Temperature @ 5V

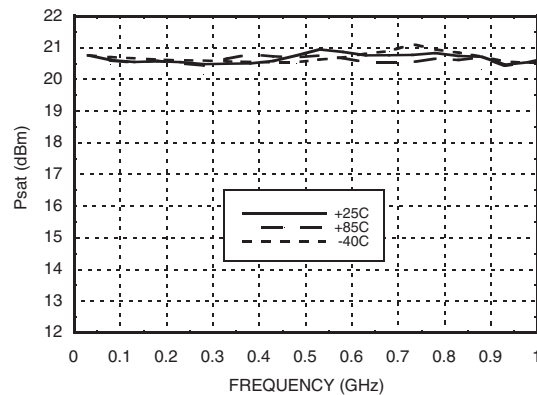

For price, delivery, and to place orders, please contact Hittite Microwave Corporation:
20 Alpha Road, Chelmsford, MA 01824 Phone: 978-250-3343 Fax: 978-250-3373
Order On-line at www.hittite.com



Gain vs. Supply Voltage

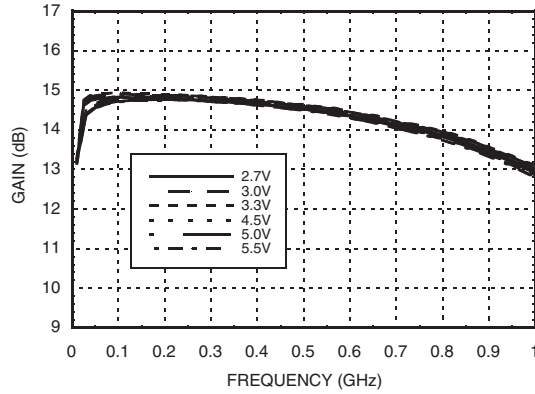

Noise Figure vs. Supply Voltage

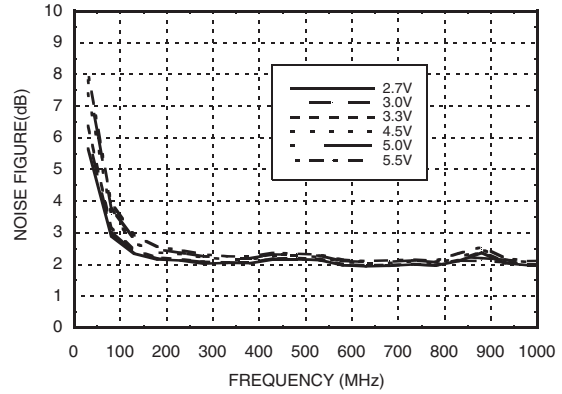

IP3 vs. Supply Voltage

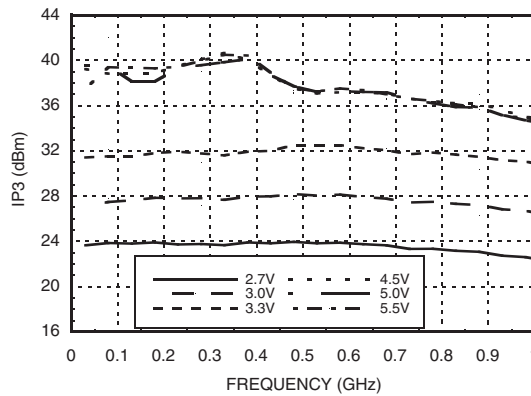

P1dB vs. Supply Voltage

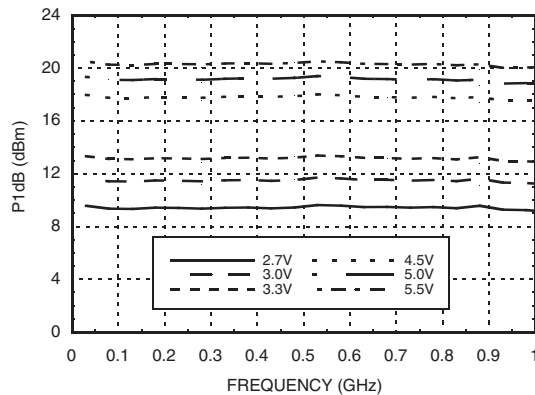

Psat vs. Supply Voltage

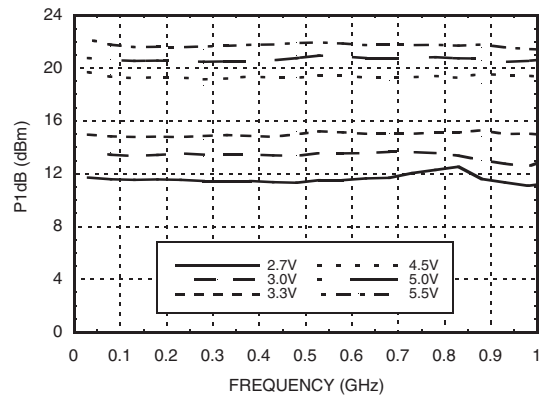

For price, delivery, and to place orders, please contact Hittite Microwave Corporation:
 20 Alpha Road, Chelmsford, MA 01824 Phone: 978-250-3343 Fax: 978-250-3373
 Order On-line at www.hittite.com

Absolute Maximum Ratings

Drain Bias Voltage (Vdd)	+6 Vdc
RF Input Power (RFIN)	+10 dBm
Channel Temperature	175 °C
Continuous Pdiss (T = 85 °C) (derate 9.84 mW/°C above 85 °C)	0.89 W
Thermal Resistance (junction to ground paddle)	101.67 °C/W
Storage Temperature	-65 to +150 °C
Operating Temperature	-40 to +85 °C

Typical Supply Current vs. Vdd

Vdd (Vdc)	Idd (mA)
+5	120
+3	120



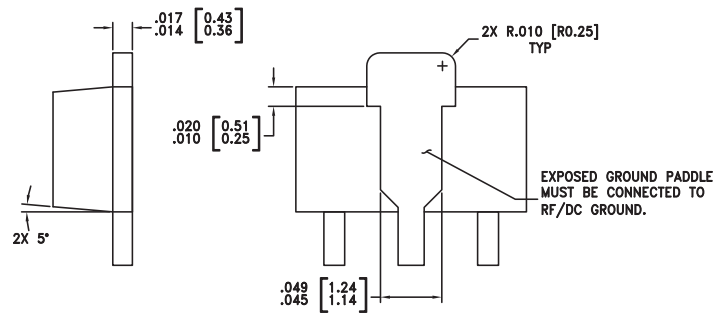
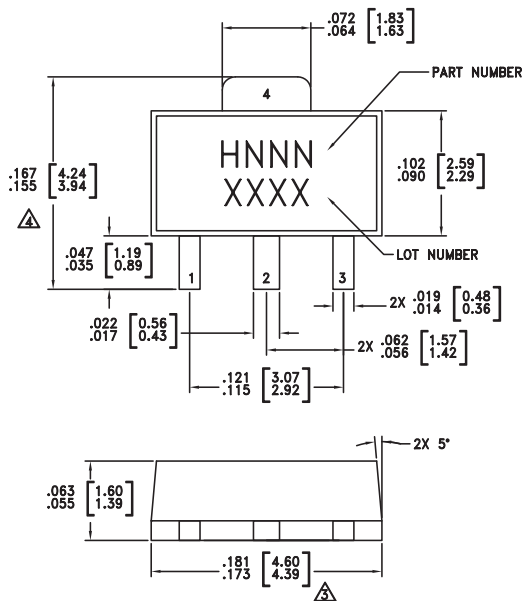

ELECTROSTATIC SENSITIVE DEVICE
OBSERVE HANDLING PRECAUTIONS

Outline Drawing



NOTES:

- LEADFRAME MATERIAL: COPPER ALLOY
- DIMENSIONS ARE IN INCHES [MILLIMETERS].
-  DIMENSION DOES NOT INCLUDE MOLDFLASH OF 0.15mm PER SIDE.
-  DIMENSION DOES NOT INCLUDE MOLDFLASH OF 0.25mm PER SIDE.
- ALL GROUND LEADS MUST BE SOLDERED TO PCB RF GROUND.

Package Information

Part Number	Package Body Material	Lead Finish	MSL Rating	Package Marking ^[3]
HMC599ST89	Low Stress Injection Molded Plastic	Sn/Pb Solder	MSL1 ^[1]	H599 XXXX
HMC599ST89E	RoHS-compliant Low Stress Injection Molded Plastic	100% matte Sn	MSL1 ^[2]	<u>H599</u> XXXX



[1] Max peak reflow temperature of 235 °C

[2] Max peak reflow temperature of 260 °C

[3] 4-Digit lot number XXXX

For price, delivery, and to place orders, please contact Hittite Microwave Corporation:
20 Alpha Road, Chelmsford, MA 01824 Phone: 978-250-3343 Fax: 978-250-3373
Order On-line at www.hittite.com

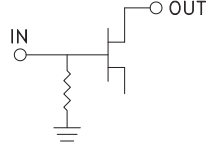
Pin Descriptions

Pin Number	Function	Description	Interface Schematic
1	IN	This pin is DC coupled. See the application circuit for off-chip components	
3	OUT	RF output and DC Bias (Vdd) for the output stage.	
2, 4	GND	These pins and package bottom must be connected to RF/DC ground.	

Application Circuit

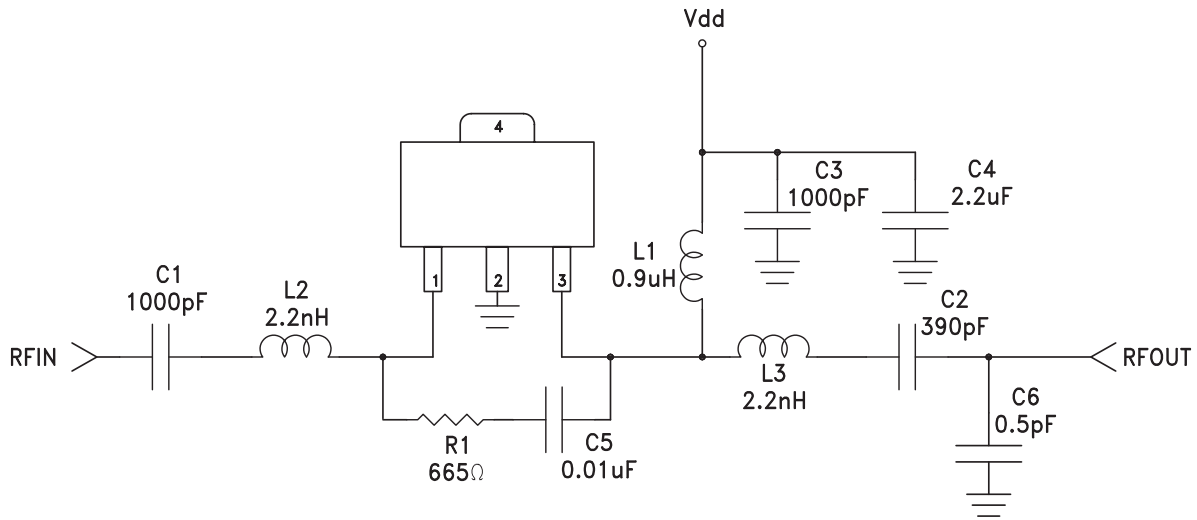

Evaluation PCB

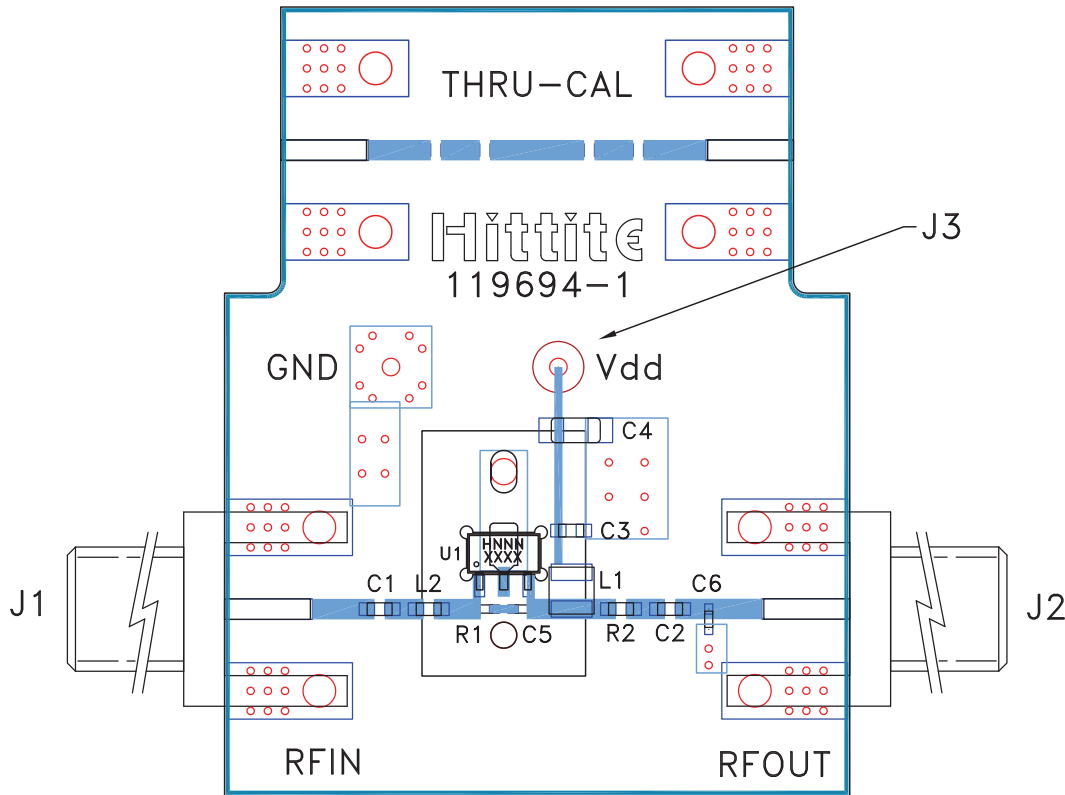

List of Materials for Evaluation PCB 119696 [1]

Item	Description
J1 - J2	PCB Mount 75 Ohm Connector
J3	DC Pin
C1, C3	1000 pF Capacitor, 0603 Pkg.
C2	390 pF Capacitor, 0603 Pkg.
C4	2.2 μF Capacitor, Tantalum
C5	10 KpF Capacitor, 0402 Pkg.
C6	0.5 pF Capacitor, 0402 Pkg.
L1	0.9 uH Inductor, 1008 Pkg.
L2, L3	2.2 nH Inductor, 0603 Pkg.
R1	665 Ohm Resistor, 0402 Pkg.
U1	HMC599ST89 / HMC599ST89E
PCB [2]	119694 Evaluation PCB

[1] Reference this number when ordering complete evaluation PCB

[2] Circuit Board Material: Rogers 4350

[3] Evaluation board tuned for 900 MHz operation

The circuit board used in the final application should use RF circuit design techniques. Signal lines should have 50 ohm impedance while the package ground leads and package bottom should be connected directly to the ground plane similar to that shown. A sufficient number of via holes should be used to connect the top and bottom ground planes. The evaluation board should be mounted to an appropriate heat sink. The evaluation circuit board shown is available from Hittite upon request.

For price, delivery, and to place orders, please contact Hittite Microwave Corporation:
20 Alpha Road, Chelmsford, MA 01824 Phone: 978-250-3343 Fax: 978-250-3373
Order On-line at www.hittite.com