

# MOS FIELD EFFECT TRANSISTOR

# $\mu$ PA2725UT1A

## SWITCHING

## N-CHANNEL POWER MOSFET

### DESCRIPTION

The  $\mu$ PA2725UT1A is N-channel MOSFET designed for DC/DC converter applications.

### FEATURES

- Low on-state resistance  
 $R_{DS(on)1} = 5.0 \text{ m}\Omega \text{ MAX. (} V_{GS} = 10 \text{ V, } I_D = 13 \text{ A)}$   
 $R_{DS(on)2} = 7.5 \text{ m}\Omega \text{ MAX. (} V_{GS} = 4.5 \text{ V, } I_D = 13 \text{ A)}$
- Low input capacitance  
 $C_{iss} = 2580 \text{ pF TYP. (} V_{DS} = 15 \text{ V, } V_{GS} = 0 \text{ V)}$
- Thin type surface mount package with heat spreader (8-pin HVSON)
- RoHS Compliant

### ABSOLUTE MAXIMUM RATINGS ( $T_A = 25^\circ\text{C}$ , All terminals are connected.)

Drain to Source Voltage ( $V_{GS} = 0 \text{ V}$ )	$V_{DSS}$	30	V
Gate to Source Voltage ( $V_{DS} = 0 \text{ V}$ )	$V_{GSS}$	$\pm 20$	V
Drain Current (DC)	$I_{D(DC)}$	$\pm 25$	A
Drain Current (pulse) <sup>Note1</sup>	$I_{D(pulse)}$	$\pm 150$	A
Total Power Dissipation <sup>Note2</sup>	$P_{T1}$	1.5	W
Total Power Dissipation ( $PW = 10 \text{ sec}$ ) <sup>Note2</sup>	$P_{T2}$	4.6	W
Channel Temperature	$T_{ch}$	150	$^\circ\text{C}$
Storage Temperature	$T_{stg}$	$-55 \text{ to } +150$	$^\circ\text{C}$
Single Avalanche Current <sup>Note3</sup>	$I_{AS}$	25	A
Single Avalanche Energy <sup>Note3</sup>	$E_{AS}$	62	mJ

### THERMAL RESISTANCE

Channel to Ambient Thermal Resistance <sup>Note2</sup>	$R_{th(ch-A)}$	83.3	$^\circ\text{C/W}$
Channel to Case (Drain) Thermal Resistance	$R_{th(ch-C)}$	1.5	$^\circ\text{C/W}$

**Notes 1.**  $PW \leq 10 \mu\text{s}$ , Duty Cycle  $\leq 1\%$

**2.** Mounted on a glass epoxy board of  $25.4 \text{ mm} \times 25.4 \text{ mm} \times 0.8 \text{ mm}$

**3.** Starting  $T_{ch} = 25^\circ\text{C}$ ,  $V_{DD} = 15 \text{ V}$ ,  $R_G = 25 \Omega$ ,  $V_{GS} = 20 \rightarrow 0 \text{ V}$ ,  $L = 100 \mu\text{H}$

**Remark** Strong electric field, when exposed to this device, can cause destruction of the gate oxide and ultimately degrade the device operation. Steps must be taken to stop generation of static electricity as much as possible, and quickly dissipate it once, when it has occurred.

The information in this document is subject to change without notice. Before using this document, please confirm that this is the latest version.  
 Not all products and/or types are available in every country. Please check with an NEC Electronics sales representative for availability and additional information.

### PACKAGE DRAWING (Unit: mm)

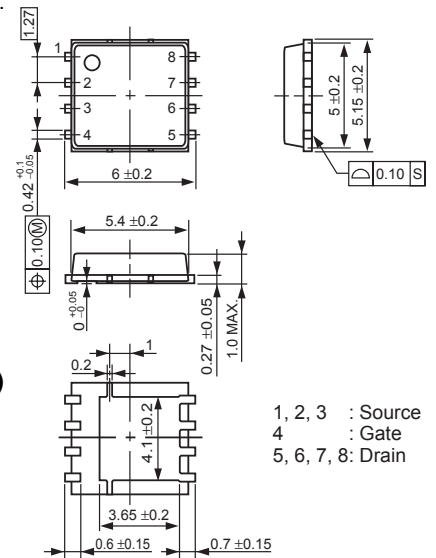

### EQUIVALENT CIRCUIT

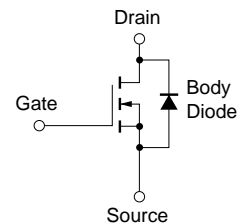

**ELECTRICAL CHARACTERISTICS (TA = 25°C, All terminals are connected.)**

CHARACTERISTICS	SYMBOL	TEST CONDITIONS	MIN.	TYP.	MAX.	UNIT
Zero Gate Voltage Drain Current	$I_{DSS}$	$V_{DS} = 30\text{ V}, V_{GS} = 0\text{ V}$			10	μA
Gate Leakage Current	$I_{GSS}$	$V_{GS} = \pm 20\text{ V}, V_{DS} = 0\text{ V}$			±100	nA
Gate to Source Cut-off Voltage	$V_{GS(off)}$	$V_{DS} = 10\text{ V}, I_D = 1\text{ mA}$	1.5		2.5	V
Forward Transfer Admittance <sup>Note</sup>	$ y_{fs} $	$V_{DS} = 10\text{ V}, I_D = 13\text{ A}$	9			S
Drain to Source On-state Resistance <sup>Note</sup>	$R_{DS(on)1}$	$V_{GS} = 10\text{ V}, I_D = 13\text{ A}$		3.8	5.0	mΩ
	$R_{DS(on)2}$	$V_{GS} = 4.5\text{ V}, I_D = 13\text{ A}$		5.5	7.5	mΩ
Input Capacitance	$C_{iss}$	$V_{DS} = 15\text{ V},$		2580		pF
Output Capacitance	$C_{oss}$	$V_{GS} = 0\text{ V},$		510		pF
Reverse Transfer Capacitance	$C_{rss}$	$f = 1\text{ MHz}$		200		pF
Turn-on Delay Time	$t_{d(on)}$	$V_{DD} = 15\text{ V}, I_D = 13\text{ A},$		17		ns
Rise Time	$t_r$	$V_{GS} = 10\text{ V},$		13		ns
Turn-off Delay Time	$t_{d(off)}$	$R_G = 10\ \Omega$		74		ns
Fall Time	$t_f$			17		ns
Total Gate Charge	$Q_G$	$V_{DD} = 15\text{ V},$		22		nC
Gate to Source Charge	$Q_{GS}$	$V_{GS} = 5\text{ V},$		7.3		nC
Gate to Drain Charge	$Q_{GD}$	$I_D = 25\text{ A}$		7.1		nC
Body Diode Forward Voltage <sup>Note</sup>	$V_{F(S-D)}$	$I_F = 25\text{ A}, V_{GS} = 0\text{ V}$		0.81		V
Reverse Recovery Time	$t_{rr}$	$I_F = 25\text{ A}, V_{GS} = 0\text{ V},$		35		ns
Reverse Recovery Charge	$Q_{rr}$	$di/dt = 100\text{ A}/\mu\text{s}$		35		nC
Gate Resistance	$R_G$	$f = 1\text{ MHz}$		2.2		Ω

**Note** Pulsed

**TEST CIRCUIT 1 AVALANCHE CAPABILITY**

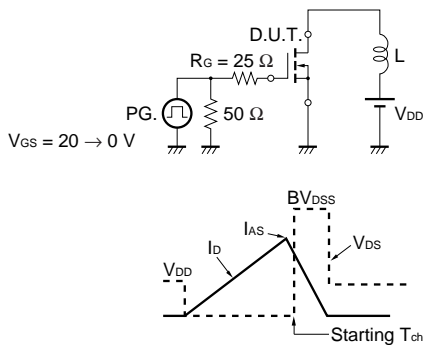

**TEST CIRCUIT 2 SWITCHING TIME**

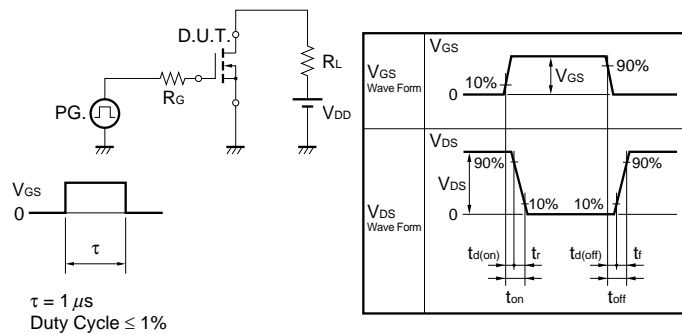

**TEST CIRCUIT 3 GATE CHARGE**

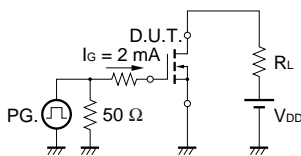

TYPICAL CHARACTERISTICS ( $T_A = 25^\circ\text{C}$ )

DERATING FACTOR OF FORWARD BIAS SAFE OPERATING AREA

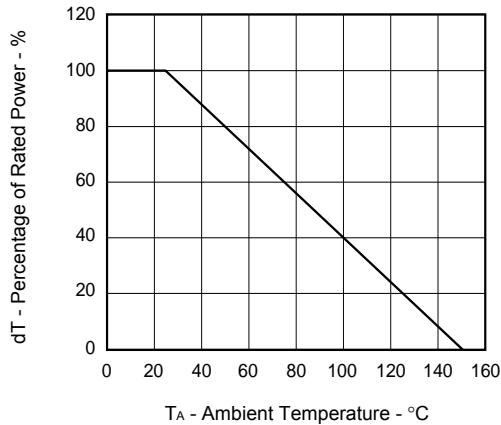

FORWARD BIAS SAFE OPERATING AREA

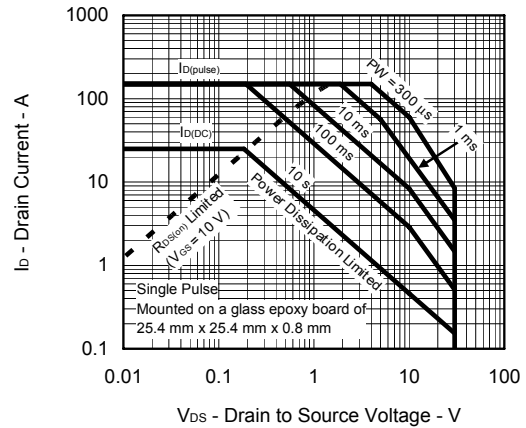

TRANSIENT THERMAL RESISTANCE vs. PULSE WIDTH

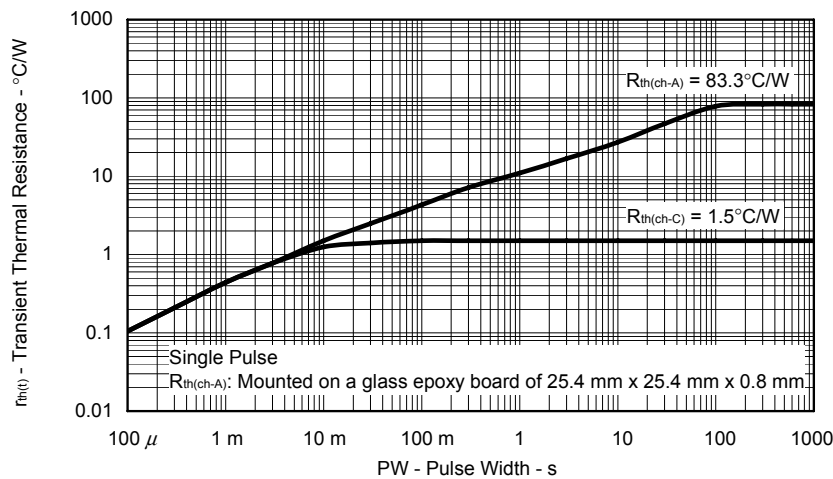

DRAIN CURRENT vs. DRAIN TO SOURCE VOLTAGE

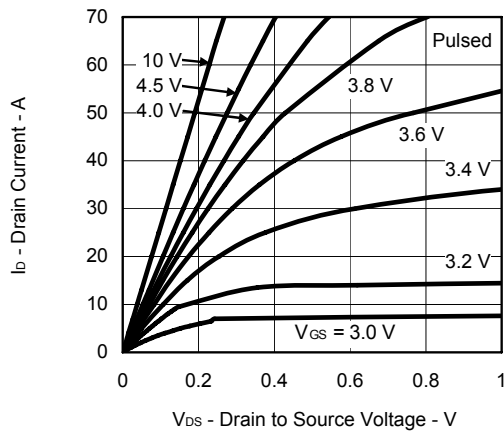

FORWARD TRANSFER CHARACTERISTICS

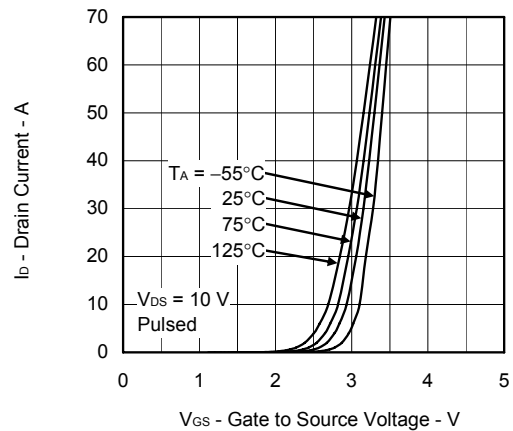

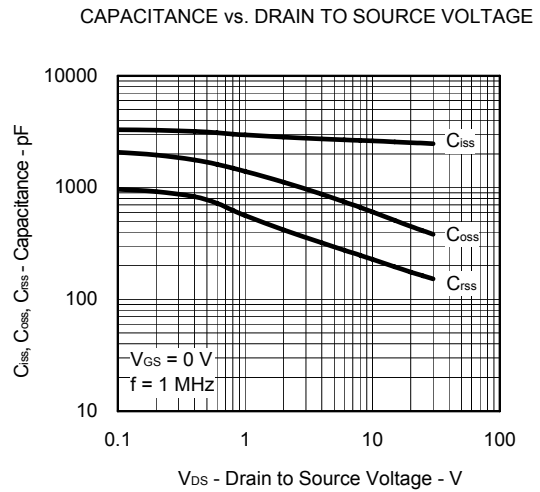
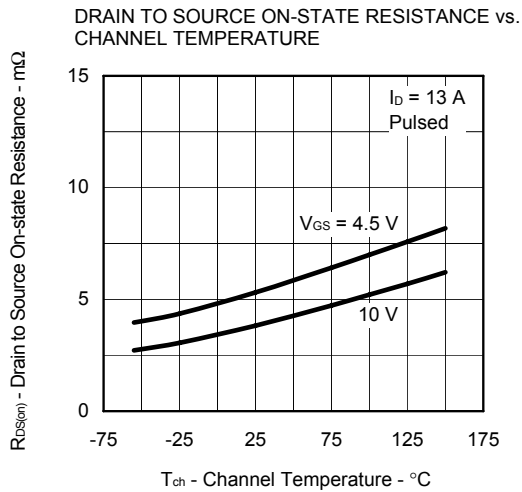
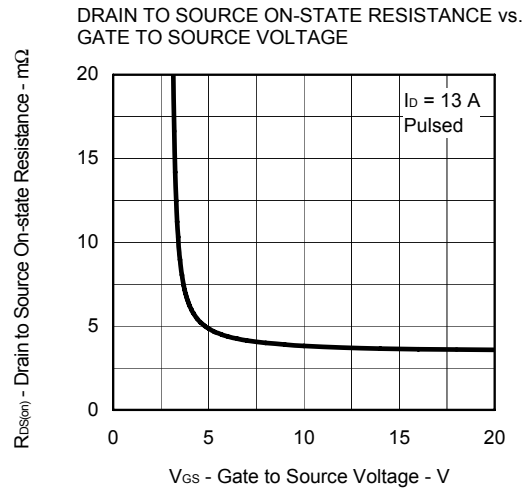
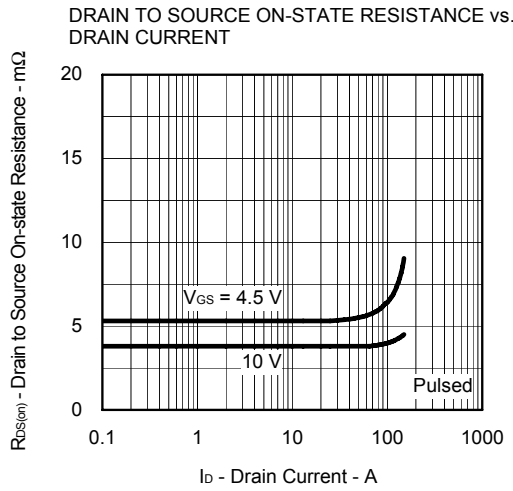
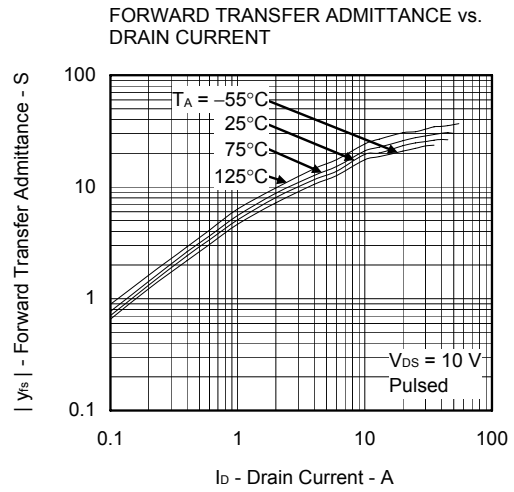
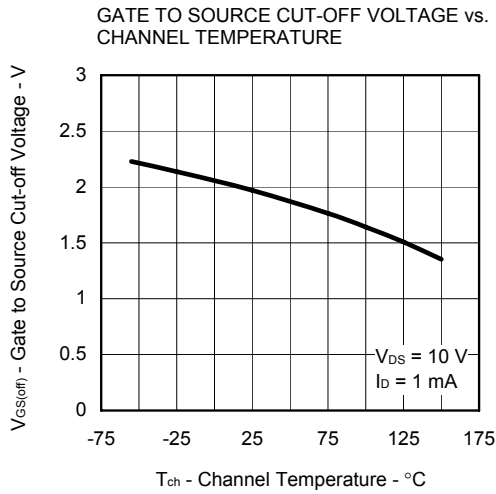

DYNAMIC INPUT/OUTPUT CHARACTERISTICS

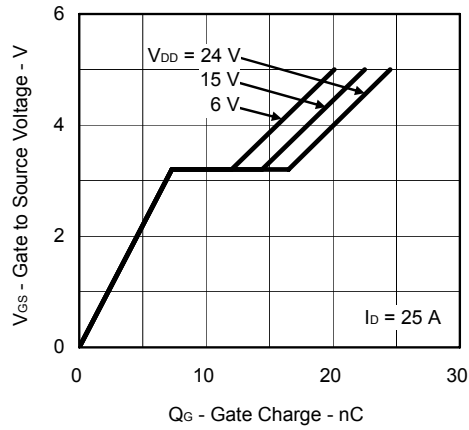

SOURCE TO DRAIN DIODE FORWARD VOLTAGE

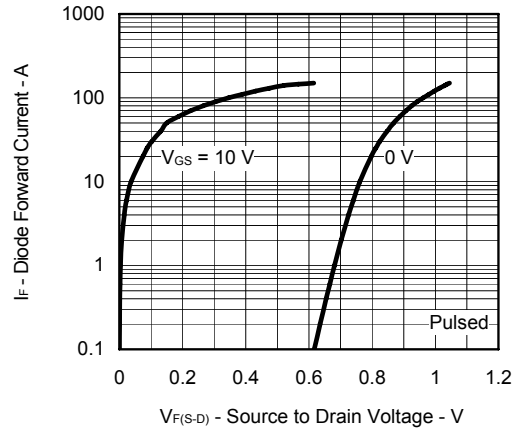

**ORDERING INFORMATION**

PART NUMBER	LEAD PLATING	PACKING	PACKAGE
$\mu$ PA2725UT1A-E1-AZ <sup>Note</sup>	Sn-Bi	Tape 3000 p/reel	8-pin HVSON 0.10 g TYP.
$\mu$ PA2725UT1A-E2-AZ <sup>Note</sup>			
$\mu$ PA2725UT1A-E1-AY <sup>Note</sup>	Pure Sn		
$\mu$ PA2725UT1A-E2-AY <sup>Note</sup>			

**Note** Pb-free (This product does not contain Pb in the external electrode.)

- **The information in this document is current as of April, 2007. The information is subject to change without notice. For actual design-in, refer to the latest publications of NEC Electronics data sheets or data books, etc., for the most up-to-date specifications of NEC Electronics products. Not all products and/or types are available in every country. Please check with an NEC Electronics sales representative for availability and additional information.**
- No part of this document may be copied or reproduced in any form or by any means without the prior written consent of NEC Electronics. NEC Electronics assumes no responsibility for any errors that may appear in this document.
- NEC Electronics does not assume any liability for infringement of patents, copyrights or other intellectual property rights of third parties by or arising from the use of NEC Electronics products listed in this document or any other liability arising from the use of such products. No license, express, implied or otherwise, is granted under any patents, copyrights or other intellectual property rights of NEC Electronics or others.
- Descriptions of circuits, software and other related information in this document are provided for illustrative purposes in semiconductor product operation and application examples. The incorporation of these circuits, software and information in the design of a customer's equipment shall be done under the full responsibility of the customer. NEC Electronics assumes no responsibility for any losses incurred by customers or third parties arising from the use of these circuits, software and information.
- While NEC Electronics endeavors to enhance the quality, reliability and safety of NEC Electronics products, customers agree and acknowledge that the possibility of defects thereof cannot be eliminated entirely. To minimize risks of damage to property or injury (including death) to persons arising from defects in NEC Electronics products, customers must incorporate sufficient safety measures in their design, such as redundancy, fire-containment and anti-failure features.
- NEC Electronics products are classified into the following three quality grades: "Standard", "Special" and "Specific".

The "Specific" quality grade applies only to NEC Electronics products developed based on a customer-designated "quality assurance program" for a specific application. The recommended applications of an NEC Electronics product depend on its quality grade, as indicated below. Customers must check the quality grade of each NEC Electronics product before using it in a particular application.

"Standard": Computers, office equipment, communications equipment, test and measurement equipment, audio and visual equipment, home electronic appliances, machine tools, personal electronic equipment and industrial robots.

"Special": Transportation equipment (automobiles, trains, ships, etc.), traffic control systems, anti-disaster systems, anti-crime systems, safety equipment and medical equipment (not specifically designed for life support).

"Specific": Aircraft, aerospace equipment, submersible repeaters, nuclear reactor control systems, life support systems and medical equipment for life support, etc.

The quality grade of NEC Electronics products is "Standard" unless otherwise expressly specified in NEC Electronics data sheets or data books, etc. If customers wish to use NEC Electronics products in applications not intended by NEC Electronics, they must contact an NEC Electronics sales representative in advance to determine NEC Electronics' willingness to support a given application.

(Note)

- (1) "NEC Electronics" as used in this statement means NEC Electronics Corporation and also includes its majority-owned subsidiaries.
- (2) "NEC Electronics products" means any product developed or manufactured by or for NEC Electronics (as defined above).