

PRELIMINARY
 Notice: This is not a final specification.
 Some parametric limits are subject to change.

MITSUBISHI Nch POWER MOSFET

FL10KM-12A

HIGH-SPEED SWITCHING USE

FL10KM-12A

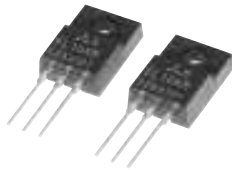

- 10V DRIVE
- V_{DSS} 600V
- r_{DS (ON)} (MAX) 1.1Ω
- I_D 10A

OUTLINE DRAWING

Dimensions in mm

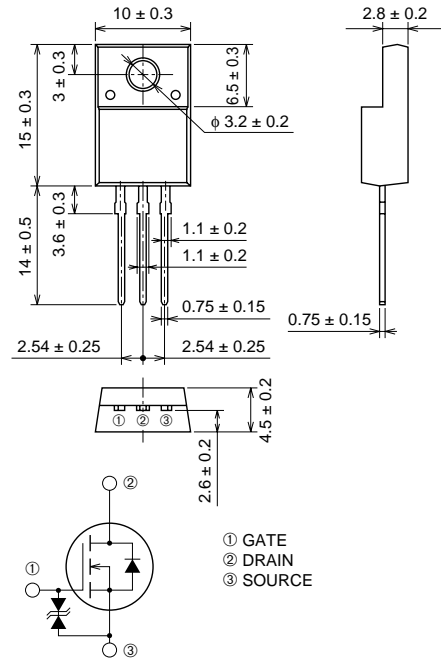

TO-220FN

APPLICATION

Switch mode power supply, Inverter fluorescent lamp, etc.

MAXIMUM RATINGS (T_c = 25°C)

Symbol	Parameter	Conditions	Ratings	Unit
V _{DSS}	Drain-source voltage	V _{GS} = 0V	600	V
V _{GSS}	Gate-source voltage	V _{DS} = 0V	±30	V
I _D	Drain current		10	A
I _{DM}	Drain current (Pulsed)		30	A
I _{DA}	Avalanche drain current (Pulsed)	L = 200μH	10	A
P _D	Maximum power dissipation		40	W
T _{ch}	Channel temperature		-55 ~ +150	°C
T _{stg}	Storage temperature		-55 ~ +150	°C
V _{iso}	Isolation voltage	AC for 1minute, Terminal to case	2000	V
—	Weight	Typical value	2.0	g

Sep.1998



PRELIMINARY
 Notice: This is not a final specification.
 Some parametric limits are subject to change.

ELECTRICAL CHARACTERISTICS (T_{ch} = 25°C)

Symbol	Parameter	Test conditions	Limits			Unit
			Min.	Typ.	Max.	
V (BR) DSS	Drain-source breakdown voltage	I _D = 1mA, V _{GS} = 0V	600	—	—	V
V (BR) GSS	Gate-source breakdown voltage	I _{GS} = ±100μA, V _{DS} = 0V	±30	—	—	V
I _{GSS}	Gate-source leakage current	V _{GS} = ±25V, V _{DS} = 0V	—	—	±10	μA
I _{DSS}	Drain-source leakage current	V _{DS} = 600V, V _{GS} = 0V	—	—	1	mA
V _{GS} (th)	Gate-source threshold voltage	I _D = 1mA, V _{DS} = 10V	2.0	3.0	4.0	V
r _{DS} (ON)	Drain-source on-state resistance	I _D = 5A, V _{GS} = 10V	—	0.92	1.10	Ω
V _{DS} (ON)	Drain-source on-state voltage	I _D = 5A, V _{GS} = 10V	—	4.60	5.50	V
y _{fs}	Forward transfer admittance	I _D = 5A, V _{DS} = 10V	—	7.0	—	S
C _{iss}	Input capacitance	V _{DS} = 25V, V _{GS} = 0V, f = 1MHz	—	1150	—	pF
C _{oss}	Output capacitance		—	135	—	pF
C _{rss}	Reverse transfer capacitance		—	45	—	pF
t _d (on)	Turn-on delay time	V _{DD} = 200V, I _D = 5A, V _{GS} = 10V, R _{GEN} = R _{GS} = 50Ω	—	24	—	ns
t _r	Rise time		—	40	—	ns
t _d (off)	Turn-off delay time		—	220	—	ns
t _f	Fall time		—	85	—	ns
V _{SD}	Source-drain voltage	I _S = 5A, V _{GS} = 0V	—	1.5	2.0	V
R _{th} (ch-c)	Thermal resistance	Channel to case	—	—	3.13	°C/W

PERFORMANCE CURVES

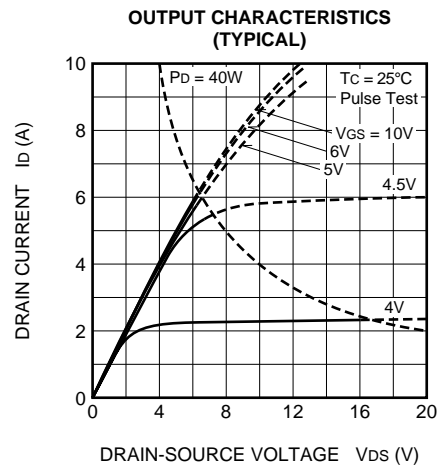
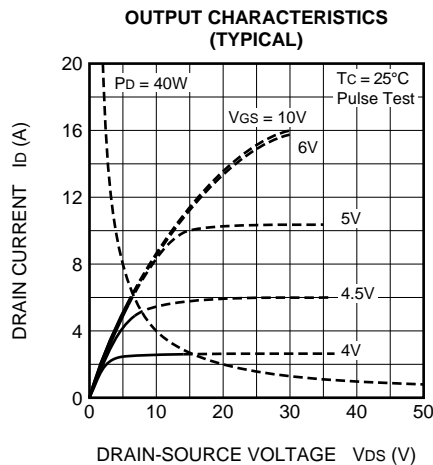
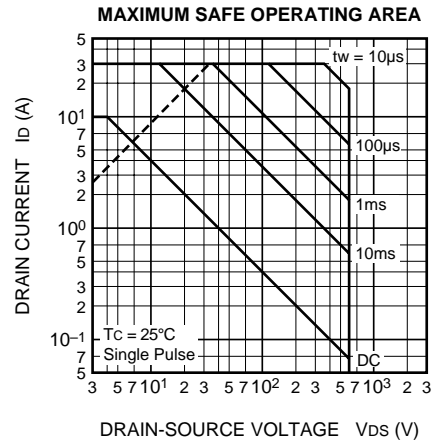
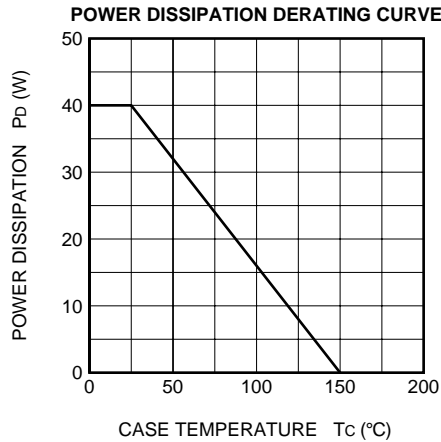

PRELIMINARY
 Notice: This is not a final specification.
 Some parametric limits are subject to change.

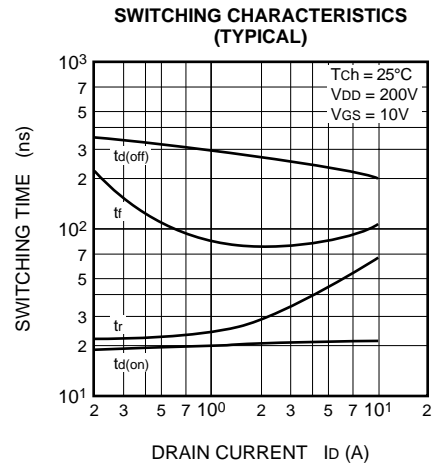
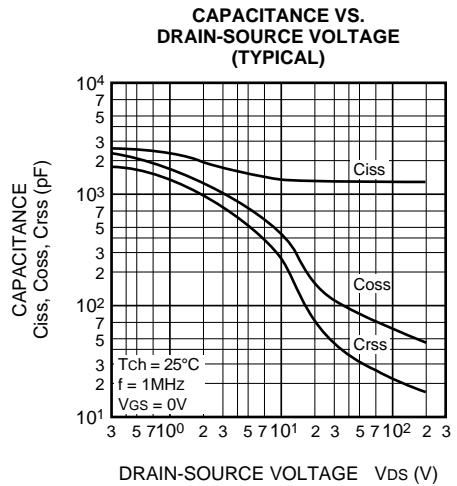
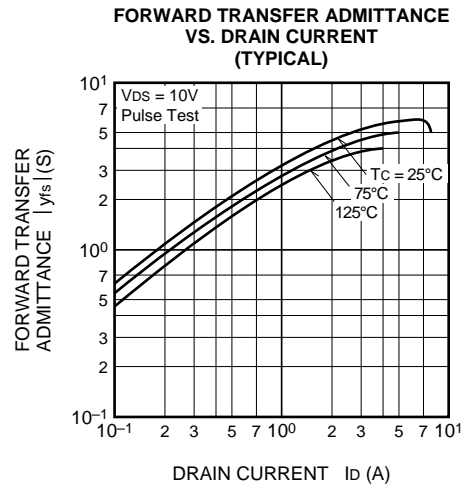
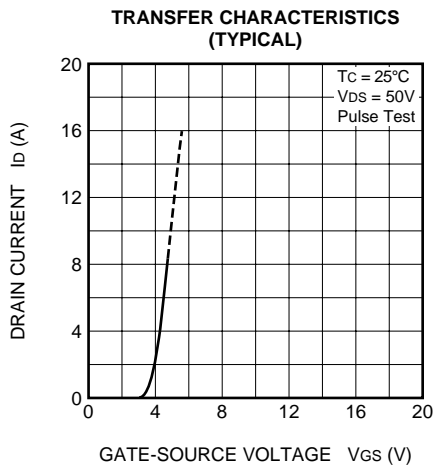
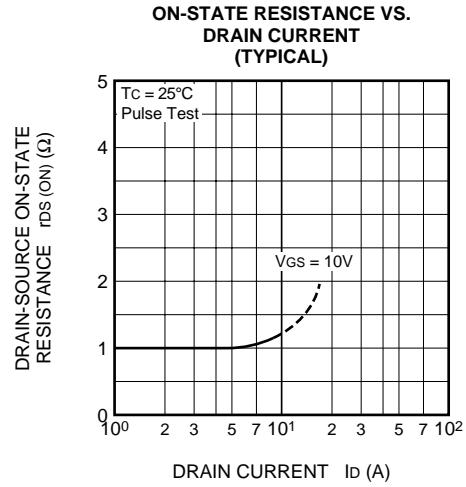
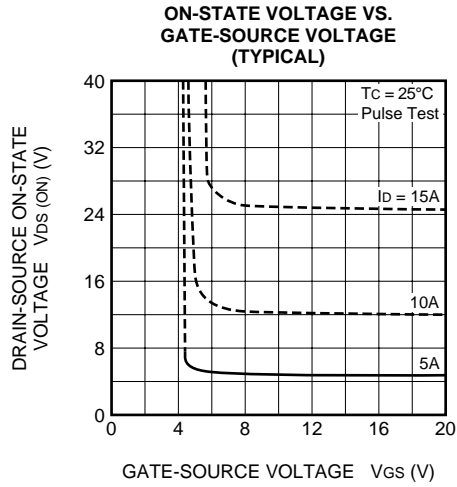

PRELIMINARY
 Notice: This is not a final specification.
 Some parametric limits are subject to change.

