



SANYO Semiconductors

DATA SHEET

LV4991TH — Bi-CMOS IC For Portable Audio Equipment Monaural BTL Power Amplifier

Overview

LV4991TH incorporates the power amplifier circuit operable at low voltage (2.7V or more) and has additionally the standby function to reduce the current drain. This is the best LSI for speaker drive for the battery-driven portable equipment, such as portable DVD player, Notebook PC, etc. The LV4991TH is a HMSOP8 (150mil) package, and The LV4991TT of MSOP8 (150mil) package is available.

Function and Feature

- Monaural BTL power amplifier incorporated
 - Standard output power 1 = 450mW ($V_{CC} = 3.6V$, $R_L = 8\Omega$, THD = 10%)
 - Standard output power 2 = 1000mW ($V_{CC} = 5V$, $R_L = 8\Omega$, THD = 10%)
 - Output coupling capacitor not necessary because of differential output type
- Operation at low voltage possible
 - $V_{CC} = 2.7V$ or more
- Standby function incorporated
 - Standard current drain at standby = 0.1 μ A ($V_{CC} = 3.6V$)
- Second amplifier stop control function incorporated : Reducing the pop sound at startup, simple MUTE
- Overheat protection circuit incorporated
- Gain setting possible
 - BTL voltage gain = 0 to 26dB
- Output phase compensation capacitor not necessary

- Any and all SANYO Semiconductor Co.,Ltd. products described or contained herein are, with regard to "standard application", intended for the use as general electronics equipment (home appliances, AV equipment, communication device, office equipment, industrial equipment etc.). The products mentioned herein shall not be intended for use for any "special application" (medical equipment whose purpose is to sustain life, aerospace instrument, nuclear control device, burning appliances, transportation machine, traffic signal system, safety equipment etc.) that shall require extremely high level of reliability and can directly threaten human lives in case of failure or malfunction of the product or may cause harm to human bodies, nor shall they grant any guarantee thereof. If you should intend to use our products for applications outside the standard applications of our customer who is considering such use and/or outside the scope of our intended standard applications, please consult with us prior to the intended use. If there is no consultation or inquiry before the intended use, our customer shall be solely responsible for the use.
 - Specifications of any and all SANYO Semiconductor Co.,Ltd. products described or contained herein stipulate the performance, characteristics, and functions of the described products in the independent state, and are not guarantees of the performance, characteristics, and functions of the described products as mounted in the customer's products or equipment. To verify symptoms and states that cannot be evaluated in an independent device, the customer should always evaluate and test devices mounted in the customer's products or equipment.

SANYO Semiconductor Co., Ltd.

TOKYO OFFICE Tokyo Bldg., 1-10, 1 Chome, Ueno, Taito-ku, TOKYO, 110-8534 JAPAN

80807 MS / 62707 MS PC / 41807 MS PC 20070313-S00013 No.A0743-1/11

LV4991TH

Specifications

Maximum Ratings at $T_a = 25^\circ\text{C}$

Parameter	Symbol	Conditions	Ratings	Unit
Maximum supply voltage	V_{CC} max		6	V
Allowable power dissipation	P_d max	Substrate mounted*	1.1	V
Operating temperature	T_{opr}		-40 to +85	$^\circ\text{C}$
Storage temperature	T_{stg}		-40 to +150	$^\circ\text{C}$

* Substrate mounted : with 60mm × 60mm × 1.6mm, glass epoxy substrate

Operating Conditions at $T_a = 25^\circ\text{C}$

Parameter	Symbol	Conditions	Ratings	Unit
Recommended supply voltage	V_{CC}		3.6	V
Recommended load resistance	R_L		8 to 32	Ω
Allowable operating supply voltage range	V_{CC} op		2.7 to 5.5	V

* Determine the supply voltage to be used with due consideration of allowable power dissipation.

Electrical Characteristics $T_a = 25^\circ\text{C}$, $V_{CC} = 3.6\text{V}$, $f_{in} = 1\text{kHz}$, $R_L = 8\Omega$

Parameter	Symbol	Conditions	Ratings			Unit
			min	typ	max	
Quiescent current drain	I_{CCOP}	No signal, $R_L = \infty$		3.6	6	mA
Stand-by current drain	I_{STBY}	No signal, $R_L = \infty$, $V_3 = \text{LOW}$		0.1	10	μA
Maximum output power 1	P_{OMX1}	THD = 10%	300	450		mW
Maximum output power 2	P_{OMX2}	THD = 10%, $V_{CC} = 5\text{V}$	665	1000		mW
Voltage gain	VG	$V_{IN} = -30\text{dBV}$	4.5	6	7.5	dB
Voltage gain use range	VGR		0		26	dB
Total harmonic distortion ratio	THD	$V_{IN} = -30\text{dBV}$		0.3	1	%
Output noise voltage	V_{NOUT}	$R_g = 620\Omega$, 20 to 20kHz		120	280	μVrms
Ripple removal ratio	SVRR	$R_g = 620\Omega$, $f_r = 100\text{Hz}$, $V_r = -20\text{dBV}$		48		dB
Output offset voltage	V_{OS}	$R_g = 620\Omega$	-50		50	mV
Reference (pin 1) voltage	VREF			1.81		V
Pin 3 control HIGH voltage	VSTBH	Power amplifier operation mode	1.9		V_{CC}	V
Pin 3 control LOW voltage	VSTBL	Power amplifier standby mode	0		0.3	V
Pin 2 control HIGH voltage	VCNTH	Second power amplifier operation mode	1.6		V_{CC}	V
Pin 2 control LOW voltage	VCNTL	Second power amplifier standby mode	0		0.3	V

LV4991TH

Package Dimensions

unit : mm (typ)

3339

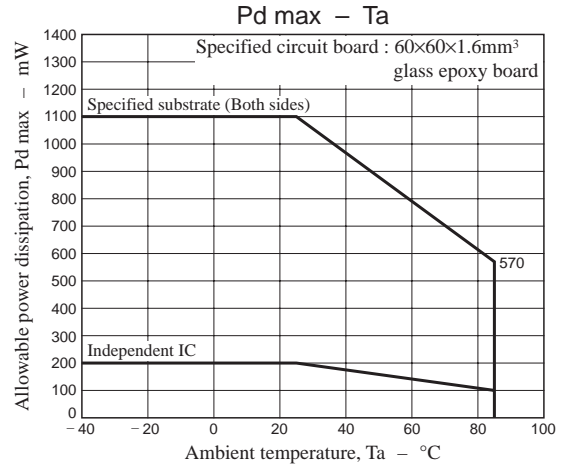
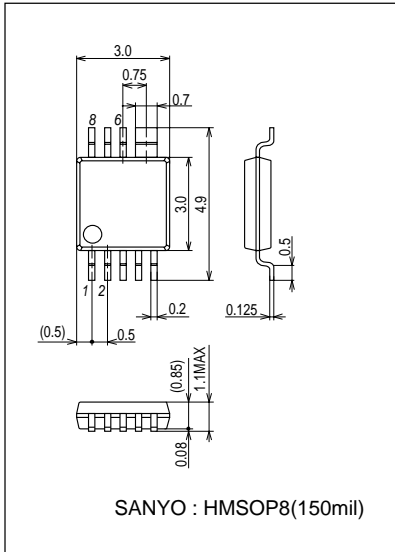

Recommended substrate

Size : 60mm×60mm×1.6mm

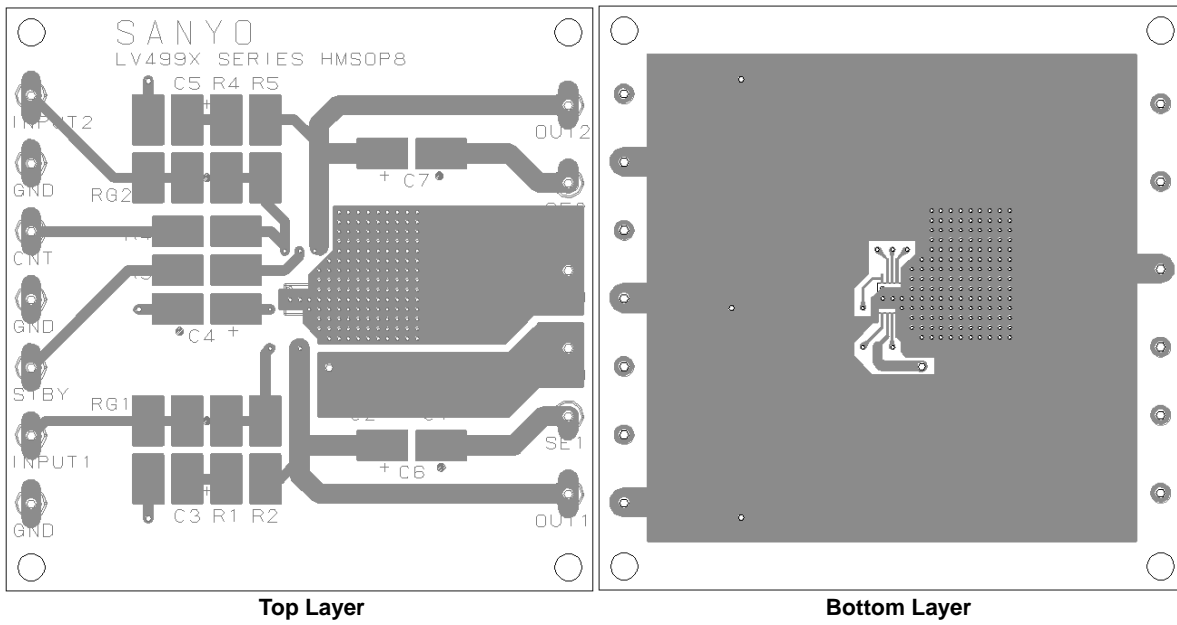

LV4991TH

Block Diagram and Sample Application Circuit

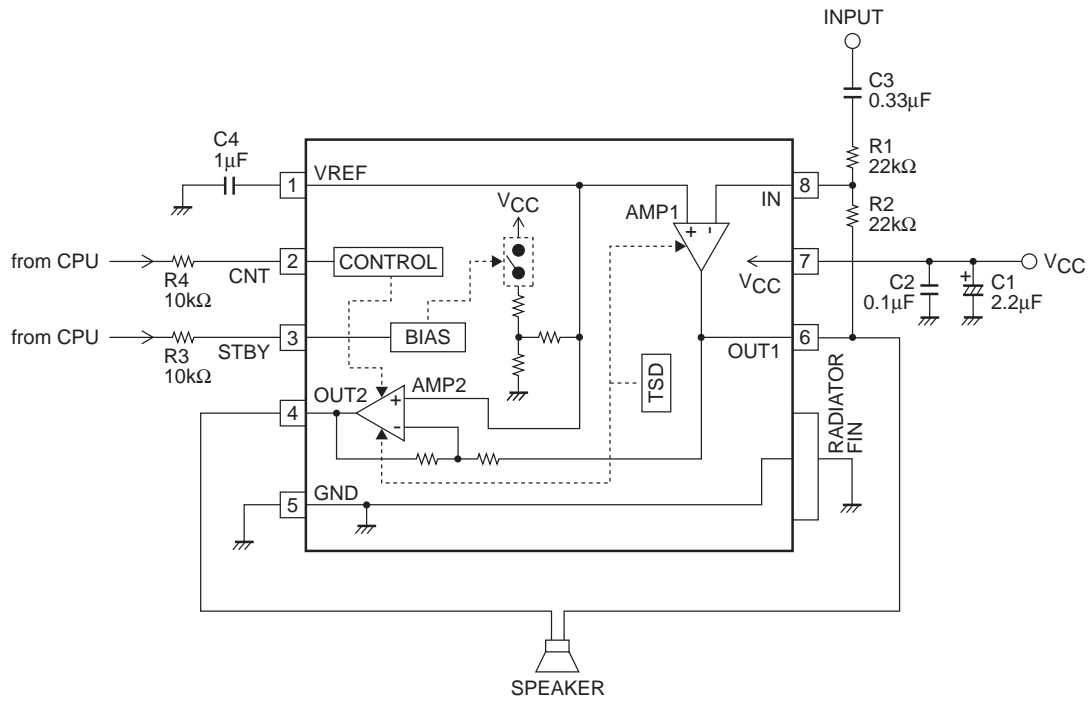

Test Circuit

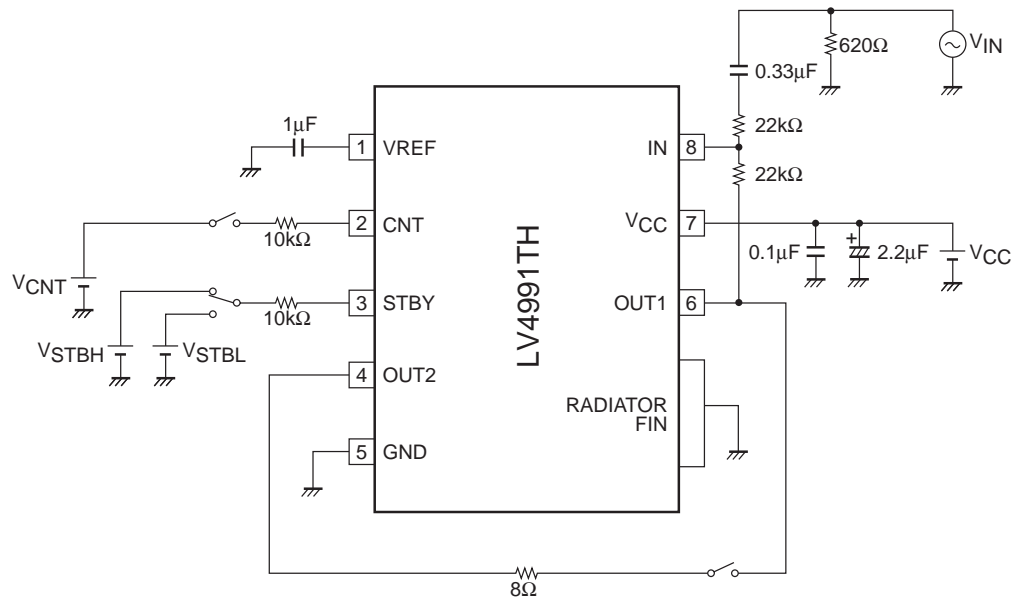

LV4991TH

Pin Description

Pin No.	Symbol	Pin voltage	Description	Equivalent circuit
		$V_{CC} = 3.6V$		
8	IN	1.81	Input pin	
3	STBY	Voltage impression	Standby pin <ul style="list-style-type: none"> •Standby mode at 0 to 0.3V •Operation mode at 1.9 to V_{CC} 	
1	VREF	1.81	Ripple filter pin (For connection of capacitor for filter)	
2	CNT	Voltage impression	Second amplifier stop control pin <ul style="list-style-type: none"> •Second amplifier stopped at 0 to 0.3V 	
4 6	OUT2 OUT1	1.81	Power amplifier output pin	
5	GND	0	Ground pin	
7	V_{CC}	Voltage impression (3.6)	Power pin	

Cautions for use

1. Input coupling capacitor (C3)

The input coupling capacitor C3 and input resistor R1 make up the high-pass filter, attenuating the bass frequency. Therefore, the capacitance value must be selected with due consideration of the pass band. Note with care that this capacitance value affects the pop sound at startup. Namely, the increased capacitance value will make the pop sound louder.

2. Pin 1 capacitor (C4)

This capacitor C4 is designed to reduce the power ripple. The ripple removal ratio increases when the capacitance is larger. Note however that this capacitor affects the pop sound at startup. Design must therefore be made by taking into both features as above described.

3. Pin 2 control (second amplifier stop control function)

Pin 2 is a pin to turn ON/OFF the operation of second amplifier. By using this function, the pop sound at startup can be reduced. Note that pin 2 can be controlled by applying the voltage described below :

- Second amplifier ON ⇒ V2 = 1.6 to V_{CC}V or OPEN
- Second amplifier OFF ⇒ V2 = 0 to 0.3V

When the pin-1 capacitor C4 is downsized, the pop sound becomes louder. The pop sound can be reduced by providing the time T_{mu} to stop the second amplifier (see Fig. 1) while utilizing this function of the microcomputer. The recommended mute time T_{mu} is as follows.

C4 [μF]	0.1	0.22	0.33
T _{mu} [ms]	≥ 170	≥ 270	≥ 280

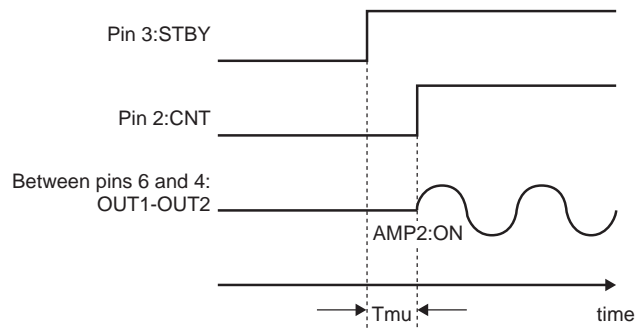

Fig. 1

4. Standby pin (pin 3)

By controlling the standby pin, the mode changeover can be made between standby and operation modes.

- Standby mode ⇒ V3 = 0 to 0.3V
- Operation mode ⇒ V3 = 1.9 to V_{CC}V

When using the standby pin as interlocked with power supply as shown in Fig. 2, care should be taken because the current I_{STBY} as expressed by the following equation flows through the standby pin.

$$I_{STBY} = \frac{V_{CC} - 1.4V}{R3 + 21k\Omega}$$

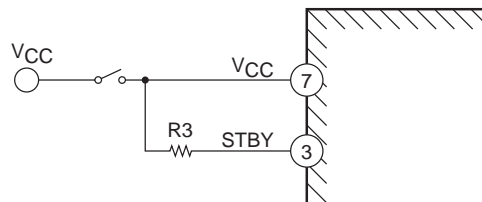
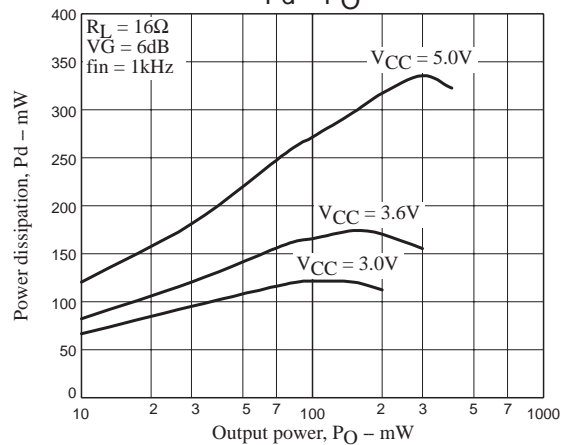
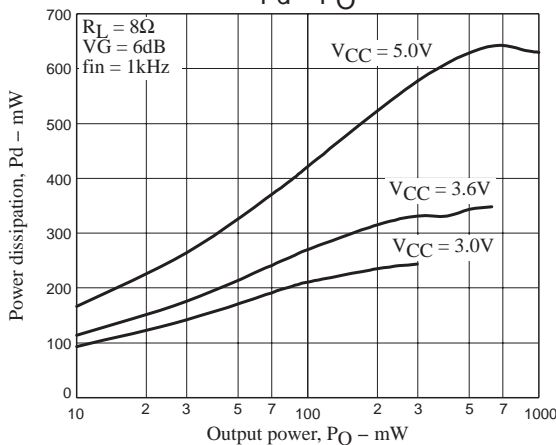
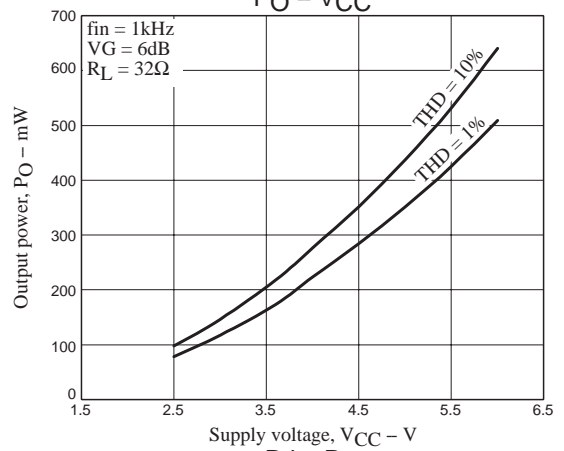
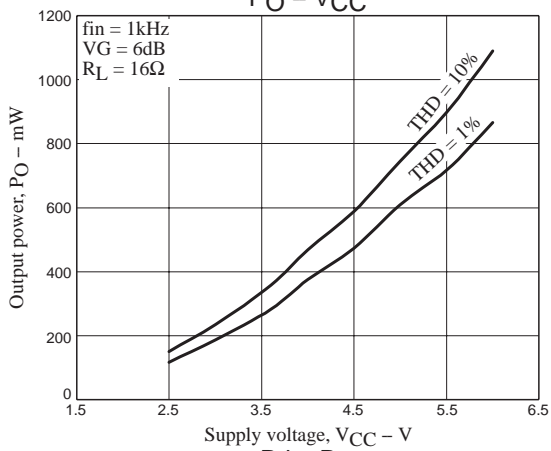
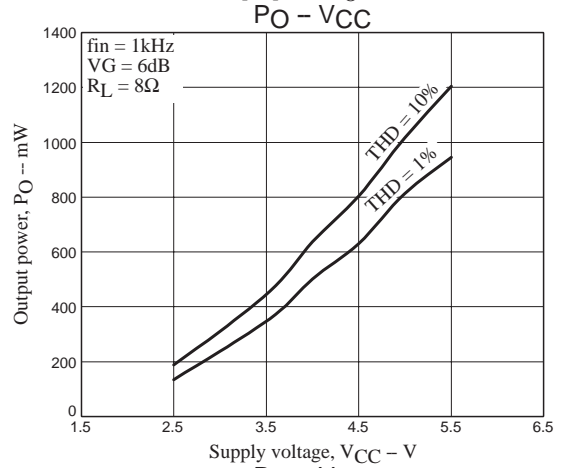
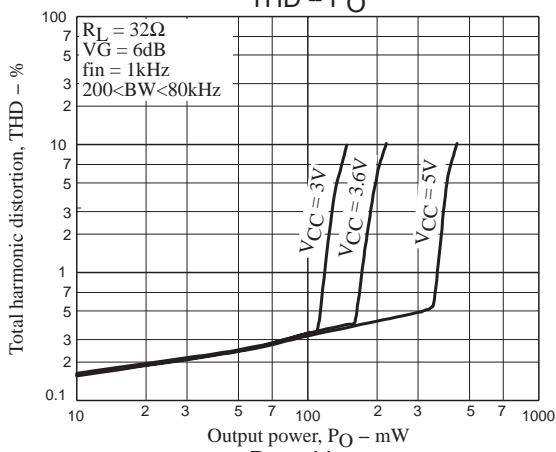
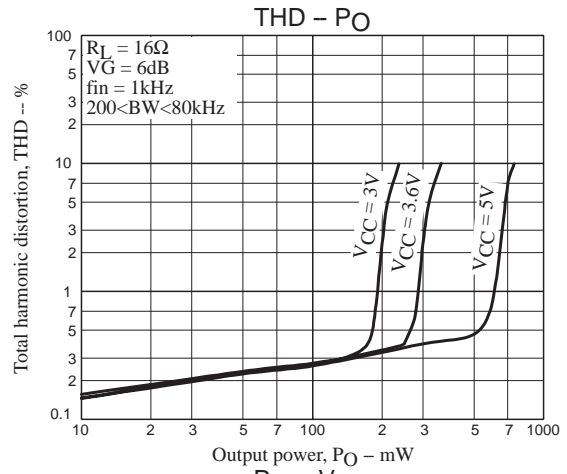
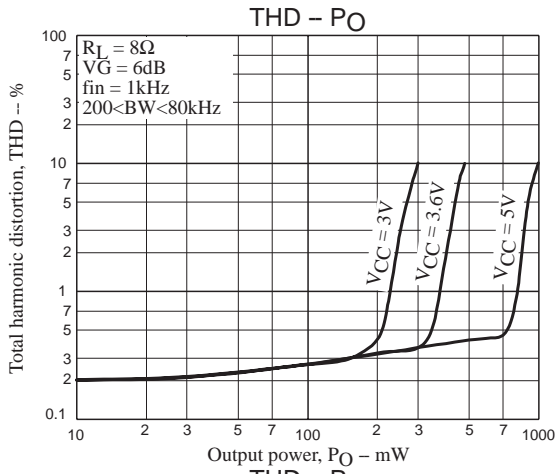
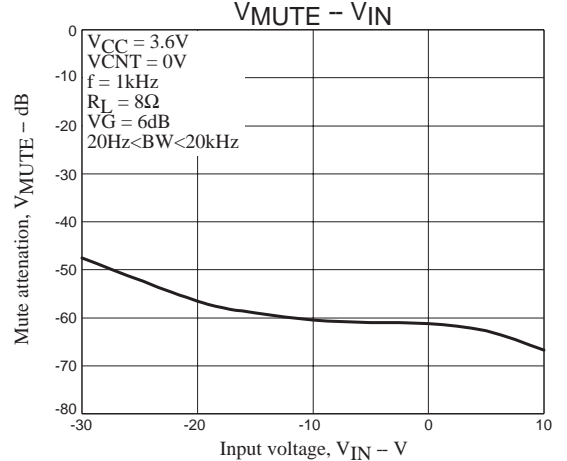
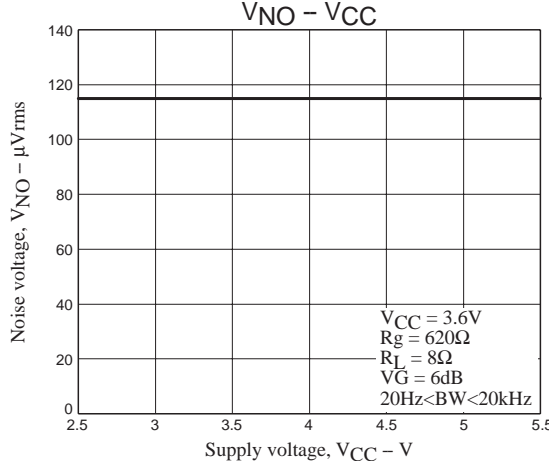
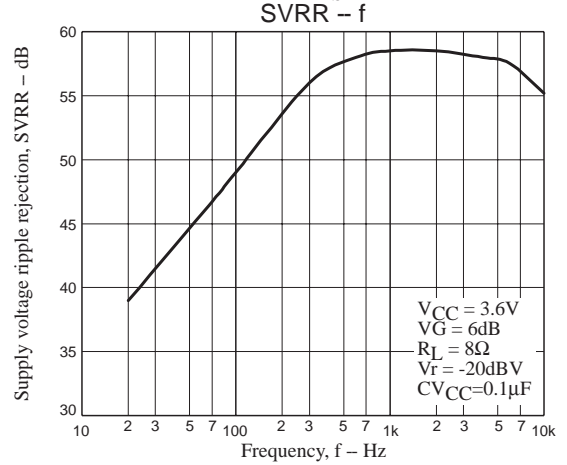
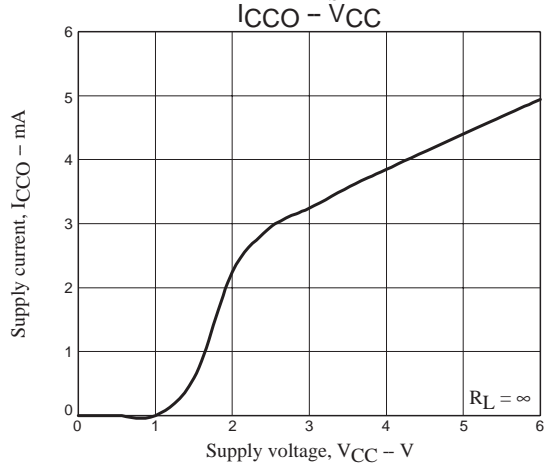
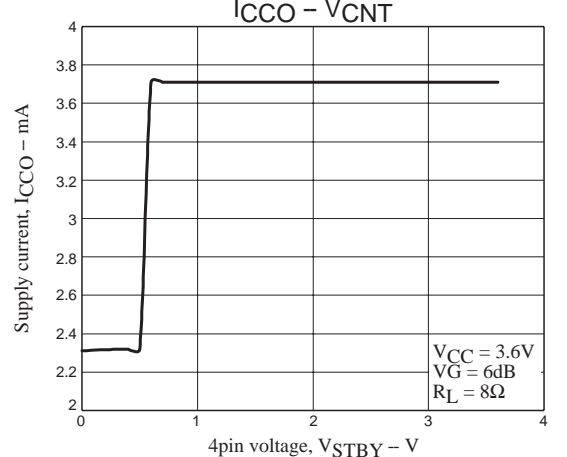
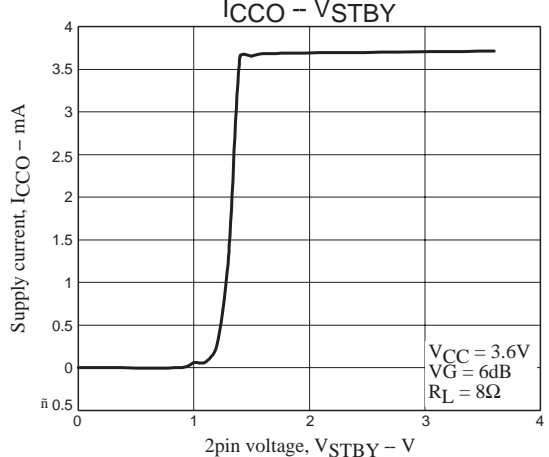
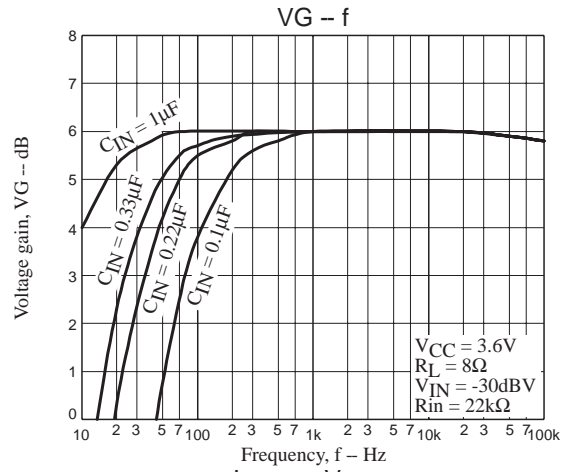
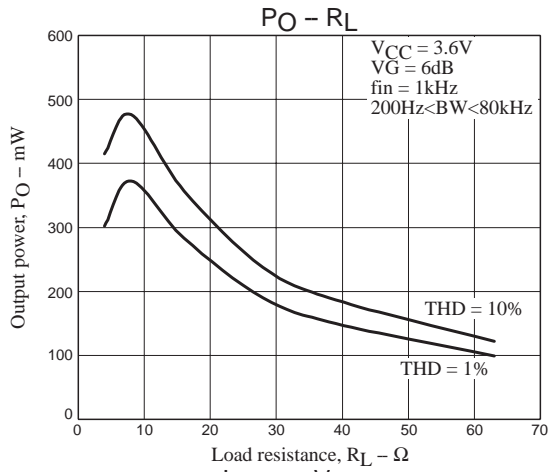

Fig. 2

LV4991TH

5. Bypass capacitor (C2) of the power supply block
The bypass capacitor attached to the power pin (pin 7) must be arranged as near to this pin as possible.
6. Short-circuit between pins
When power is applied with pins left short-circuited, deterioration or damage may result.
Therefore, check before power application if pins are short-circuited with solder, etc. during mounting of IC to the substrate.
7. Short-circuit of load
If the load is left short-circuited for a long period of time, deterioration or damage may occur.
Never allow the load to short-circuit.
8. Maximum rating
When IC is used near the maximum rating, there is a possibility that the maximum rating may be exceeded even under the smallest change of conditions, resulting in failure. Take the sufficient margin for variation of supply voltage and use IC within a range where the maximum rating will never be exceeded.





LV4991TH

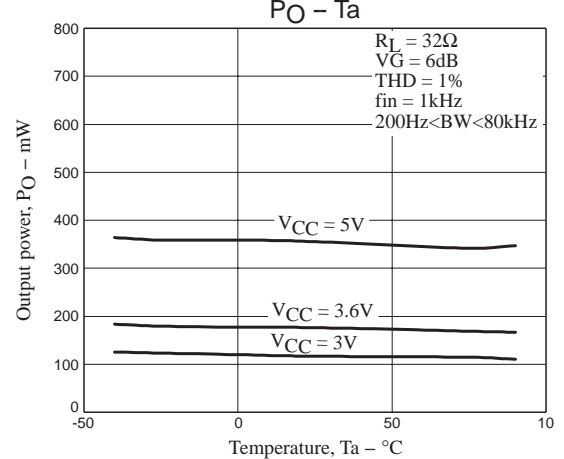
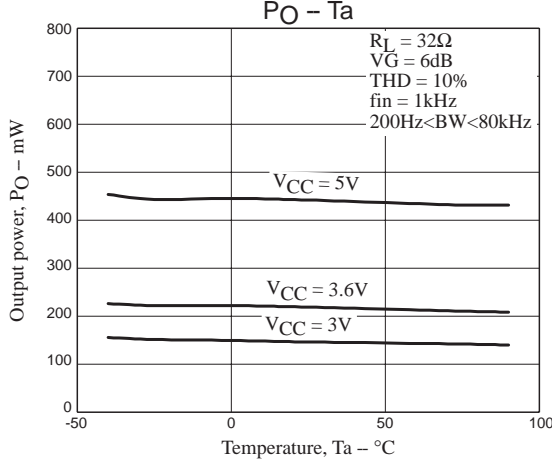
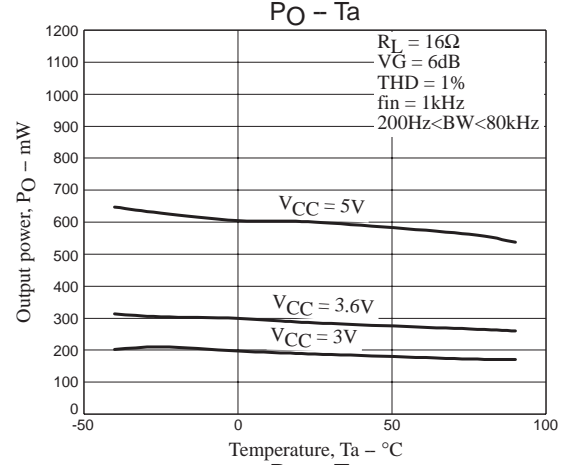
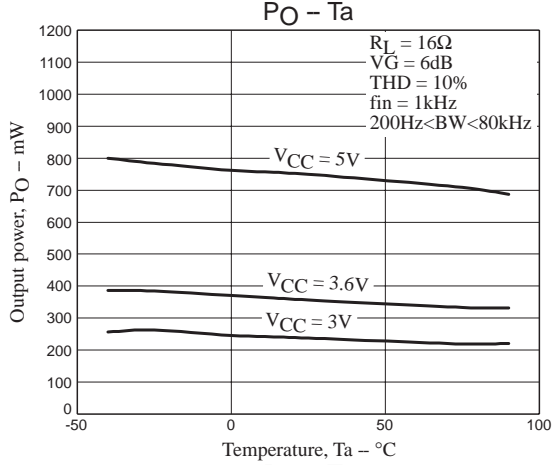
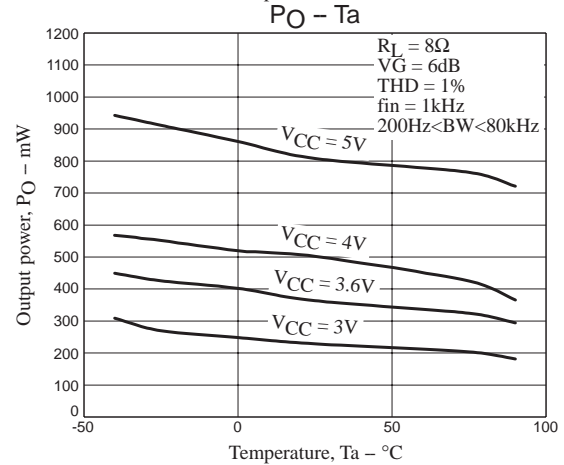
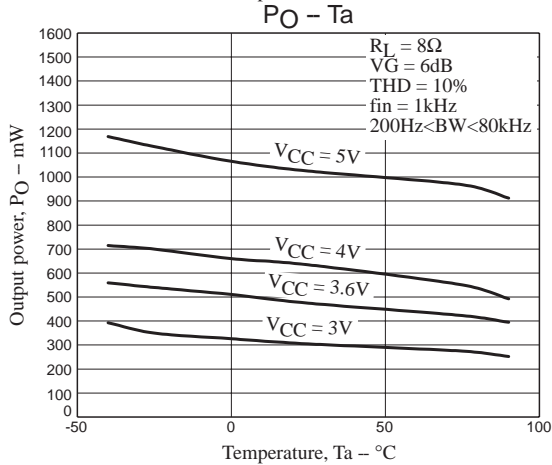
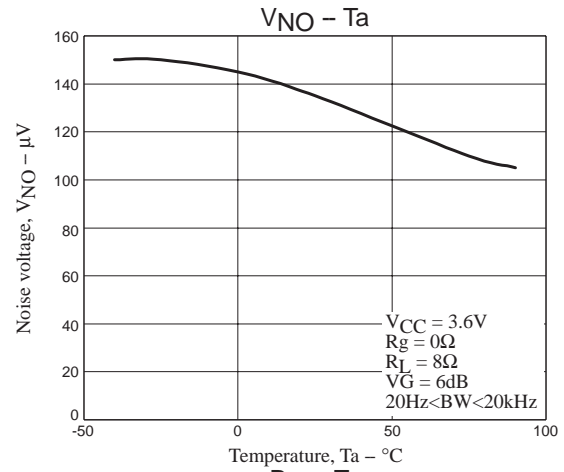
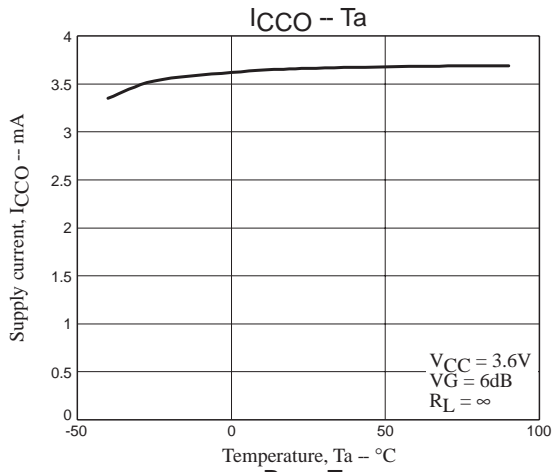

Pop sound

1. Startup

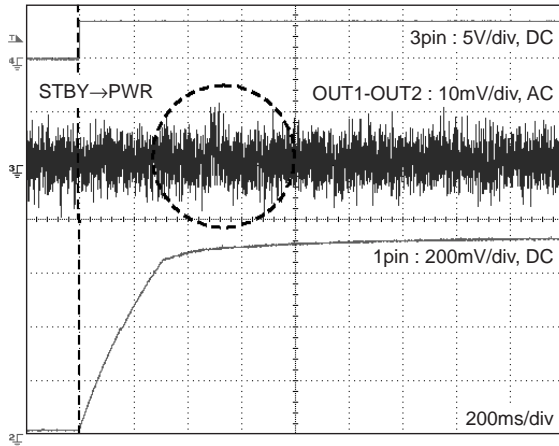

2. Fall

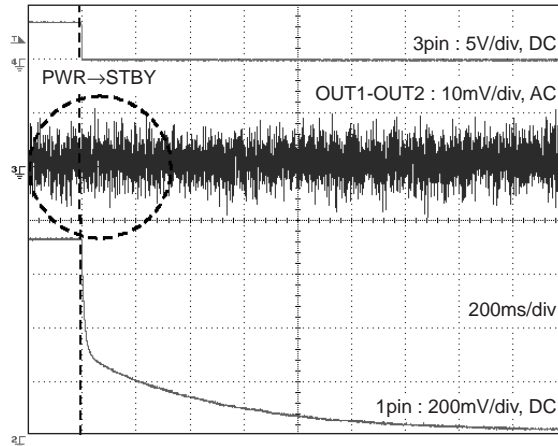

- SANYO Semiconductor Co.,Ltd. assumes no responsibility for equipment failures that result from using products at values that exceed, even momentarily, rated values (such as maximum ratings, operating condition ranges, or other parameters) listed in products specifications of any and all SANYO Semiconductor Co.,Ltd. products described or contained herein.
- SANYO Semiconductor Co.,Ltd. strives to supply high-quality high-reliability products, however, any and all semiconductor products fail or malfunction with some probability. It is possible that these probabilistic failures or malfunction could give rise to accidents or events that could endanger human lives, trouble that could give rise to smoke or fire, or accidents that could cause damage to other property. When designing equipment, adopt safety measures so that these kinds of accidents or events cannot occur. Such measures include but are not limited to protective circuits and error prevention circuits for safe design, redundant design, and structural design.
- In the event that any or all SANYO Semiconductor Co.,Ltd. products described or contained herein are controlled under any of applicable local export control laws and regulations, such products may require the export license from the authorities concerned in accordance with the above law.
- No part of this publication may be reproduced or transmitted in any form or by any means, electronic or mechanical, including photocopying and recording, or any information storage or retrieval system, or otherwise, without the prior written consent of SANYO Semiconductor Co.,Ltd.
- Any and all information described or contained herein are subject to change without notice due to product/technology improvement, etc. When designing equipment, refer to the "Delivery Specification" for the SANYO Semiconductor Co.,Ltd. product that you intend to use.
- Information (including circuit diagrams and circuit parameters) herein is for example only; it is not guaranteed for volume production.
- Upon using the technical information or products described herein, neither warranty nor license shall be granted with regard to intellectual property rights or any other rights of SANYO Semiconductor Co.,Ltd. or any third party. SANYO Semiconductor Co.,Ltd. shall not be liable for any claim or suits with regard to a third party's intellectual property rights which has resulted from the use of the technical information and products mentioned above.

This catalog provides information as of August, 2007. Specifications and information herein are subject to change without notice.