

# 2-Way 0° Power Divider

## 5 – 2400 MHz

MAPDCT0012



SM-156 Package

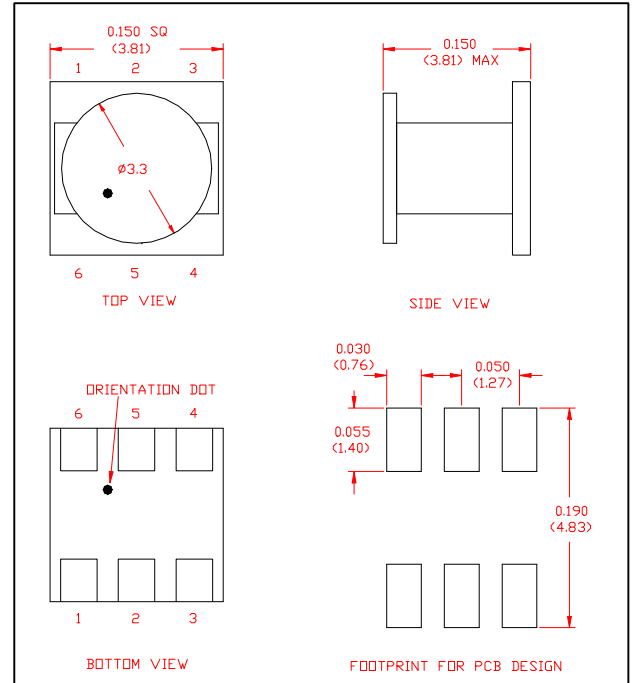

### Features

- 2 Way
- Surface Mount
- 0 Degree
- Very Broad Band performance

### Description

M/A-COM's MAPDCT0012 is a 2 Way 0° Power Divider in a low cost, surface mount package. Ideally suited for high volume CATV & VSAT applications.

### Electrical Specifications @ 25°C, $Z_0 = 75$ Ohms

Frequency Range 5 - 2400 MHz	Test Conditions	Nominal	Units	Min.	Typ.	Max.
Insertion Loss (Above 3dB)	5 - 870 MHz	—	dB	—	0.7	1.0
	870 - 1000 MHz	—	dB	—	0.9	1.1
	1000 - 2150 MHz	—	dB	—	1.2	2.5
	2150 - 2400 MHz	—	dB	—	2.8	3.9
Isolation	5 - 2400 MHz	—	dB	10	18	—
Amplitude Unbalance	5 - 1000 MHz	—	dB	—	0.2	0.7
	1000 - 2150 MHz	—	dB	—	0.8	1.5
	2150 - 2400 MHz	—	dB	—	1.3	1.8
Phase Unbalance	5 - 1000 MHz	—	°	—	2°	5°
	1000 - 2150 MHz	—	°	—	2°	10°
	2150 - 2400 MHz	—	°	—	4°	12°
Input Return Loss	5 - 2150 MHz	—	dB	—	10	9
	2150 - 2400 MHz	—	dB	—	9	6
Output Return Loss	5 - 1000 MHz	—	dB	—	15	10
	1000 - 2400 MHz	—	dB	—	9	6

Note: Specifications subject to change without notice.

**Absolute Maximum Ratings**

Parameter	Absolute Maximum
RF Power	1 Watt
Internal Load Dissipation	0.125 Watt
Storage Temperature	-40° C to +85°C
Operating Temperature	-40° C to +80°C

**Operating Characteristics**

Function	Pin No.
Input	1
Output Port 1	3
Output Port 2	4
Ground	6
Not Used (GND)	2&5

**Schematic**

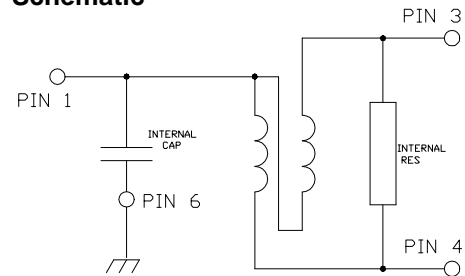

**Typical Performance @ +25° C**

**Insertion Loss Port 1**

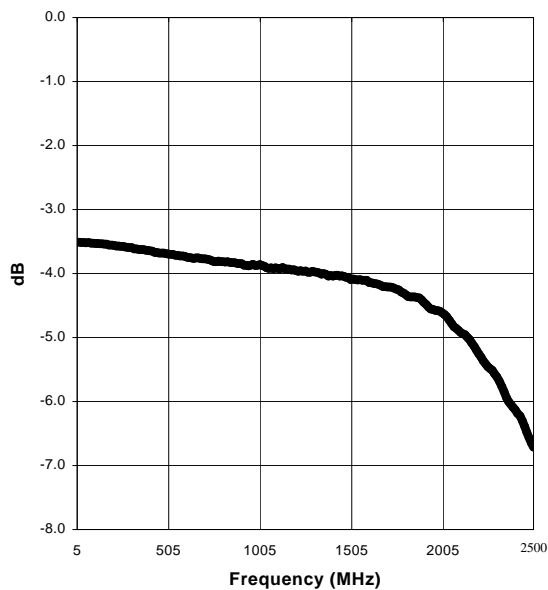

**Insertion Loss port 2**

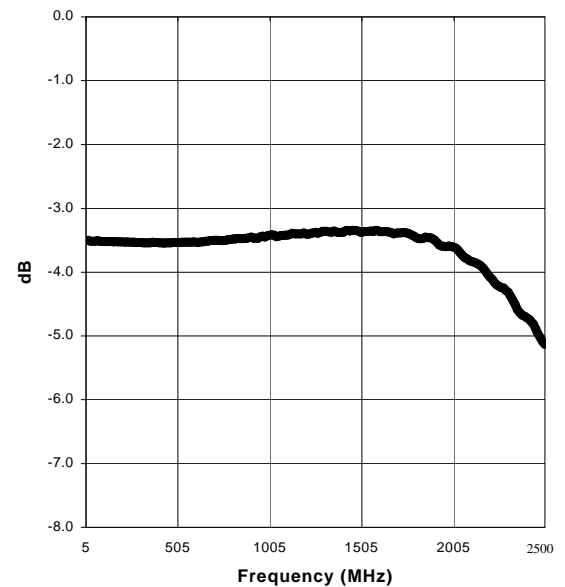

Specifications subject to change without notice.

- North America: Tel. (800) 366-2266, Fax (800) 618-8883
- Asia/Pacific: Tel.+81-44-844-8296, Fax +81-44-844-8298
- Europe: Tel. +44 (1908) 574 200, Fax+44 (1908) 574 300

Visit [www.macom.com](http://www.macom.com) for additional data sheets and product information.



Rev -

**Amplitude Unbalance**

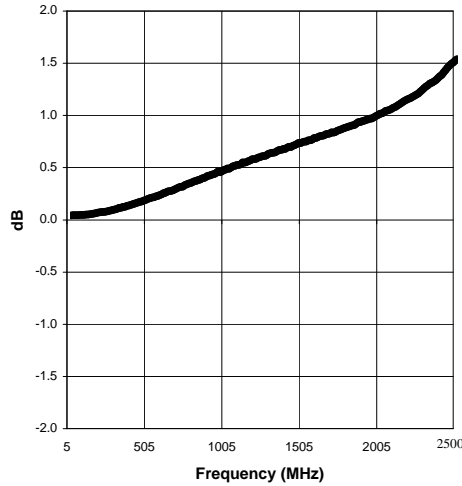

**Phase Unbalance**

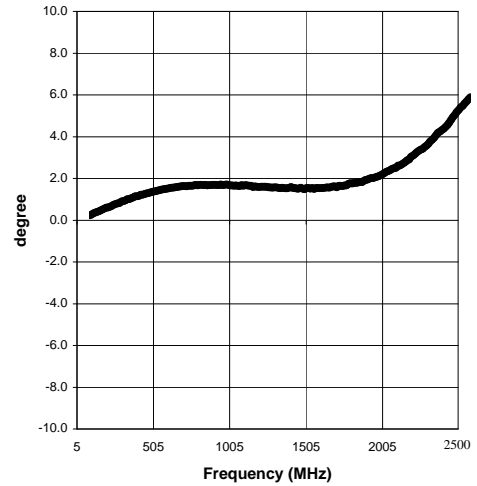

**Isolation**

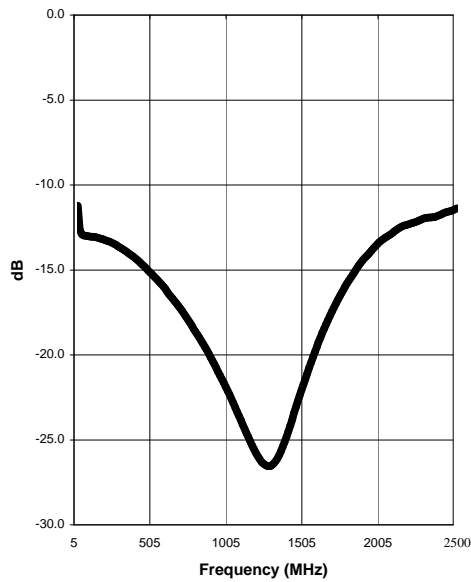

**Input Return Loss**

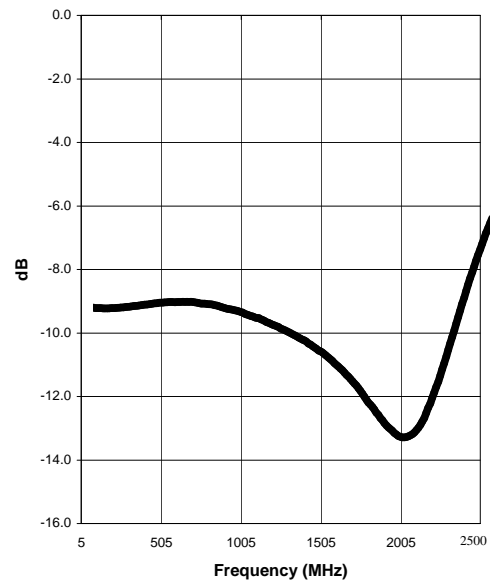

Specifications subject to change without notice.

- North America: Tel. (800) 366-2266, Fax (800) 618-8883
- Asia/Pacific: Tel.+81-44-844-8296, Fax +81-44-844-8298
- Europe: Tel. +44 (1908) 574 200, Fax+44 (1908) 574 300

Visit [www.macom.com](http://www.macom.com) for additional data sheets and product information.

Rev -

