

**Low Cost Two-Way SMT Power Divider
1510-1600 MHz**

**MAPDCC0003
V2**

Features

- Small Size and Low Profile
- Industry Standard SOIC-8 SMT Plastic Package
- Excellent Amplitude and Phase Balance
- Superior Repeatability
- Typical Insertion Loss 0.4 dB
- Typical Isolation 20 dB
- 1 Watt Power Handling
- Frequency Coverage for GPS and LEO Programs
- Lead-Free SOIC-8 Package
- 100% Matte Tin Plating over Copper
- Halogen-Free “Green” Mold Compound
- 260°C Reflow Compatible
- RoHS* Compliant Version of DS52-0004

Description

M/A-COM's MAPDCC0003 is an IC-based monolithic power divider in a low cost SOIC-8 plastic package. This 2-way power divider is ideally suited for applications where small size, low insertion loss, superior phase/amplitude tracking and low cost are required. Typical applications include base station switching networks and other communication applications where size and PCB real estate are a premium. Available in tape and reel.

The MAPDCC0003 is fabricated using a passive-integrated circuit process. The process features full-chip passivation for increased performance and reliability.

Ordering Information

Part Number	Package
MAPDCC0003	Bulk Packaging
MAPDCC0003-TR	1000 Piece Reel
MAPDCC0003-TB	Sample Test Board

Note: Reference Application Note M513 for reel size information.

Note: Die quantity varies.

* Restrictions on Hazardous Substances, European Union Directive 2002/95/EC.

Functional Diagram

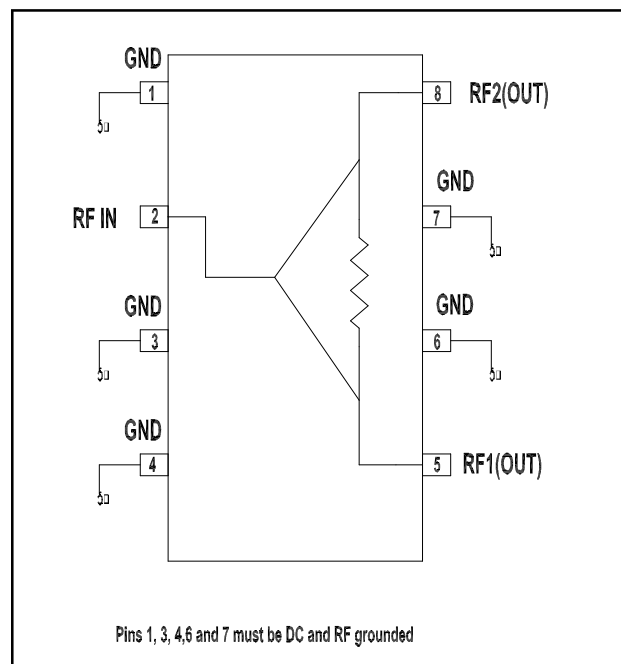

Pin Configuration

Pin No.	Function
1	GND
2	RF-IN
3	GND
4	GND
5	RF-1 (out)
6	GND
7	GND
8	RF-2 (out)

**Low Cost Two-Way SMT Power Divider
1510-1600 MHz**

**MAPDCC0003
V2**

Electrical Specifications¹: T_A = +25°C

Parameter	Units	Min	Typ	Max
Insertion Loss	Above 3.0dB	—	0.4	0.6
Isolation		15	20	—
VSWR	Input RL	—	1.3:1	1.5:1
VSWR	Output RL	—	1.4:1	1.6:1
Amplitude Balance		—	0.1	0.2
Phase Balance	Deg	—	1.0	3.0

1. All specifications apply with a 50-Ohm source and load impedance.

Absolute Maximum Ratings^{2,3}

Parameter	Absolute Maximum
Input Power ⁴	1 W CW
Operating Temperature	-40°C to +85°C
Storage Temperature	-65°C to +150°C

- Exceeding any one or combination of these limits may cause permanent damage to this device.
- M/A-COM does not recommend sustained operation near these survivability limits.
- With Internal load dissipation of 0.125 W maximum.

Recommended PCB Configuration

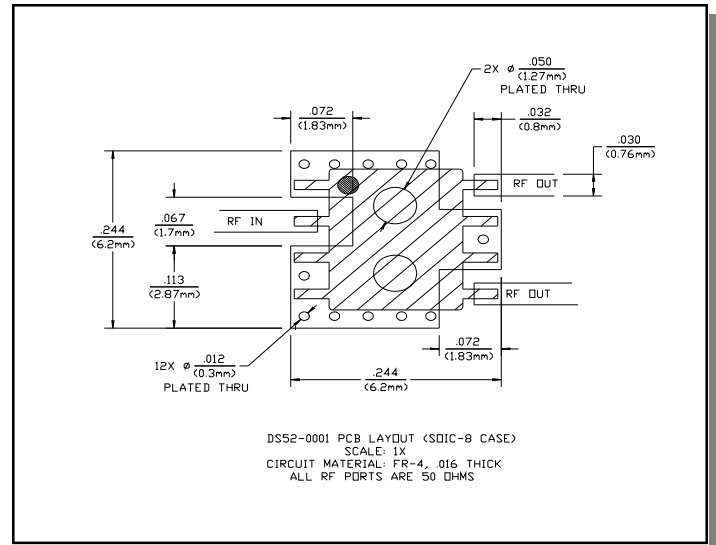

Handling Procedures

Please observe the following precautions to avoid damage:

Static Sensitivity

GMIC Circuits are sensitive to electrostatic discharge (ESD) and can be damaged by static electricity. Proper ESD control techniques should be used when handling these devices.

**Low Cost Two-Way SMT Power Divider
1510-1600 MHz**

**MAPDCC0003
V2**

Typical Performance @ 25°C

Insertion Loss vs. Frequency

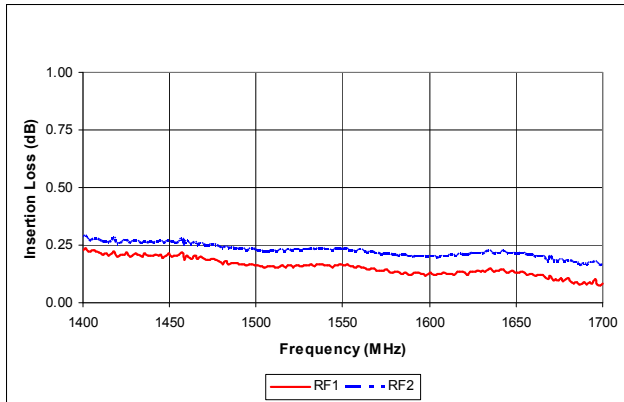

Isolation vs. Frequency

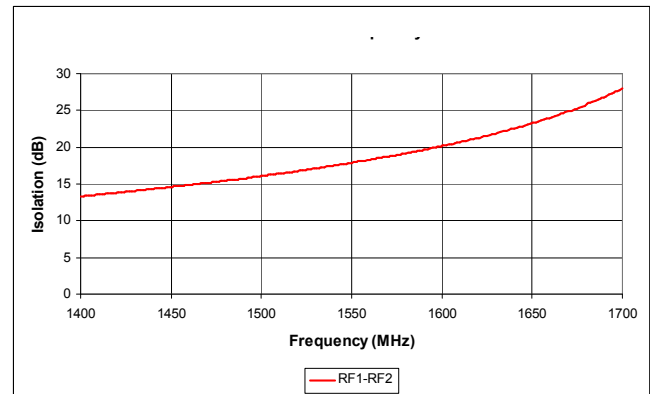

VSWR vs. Frequency

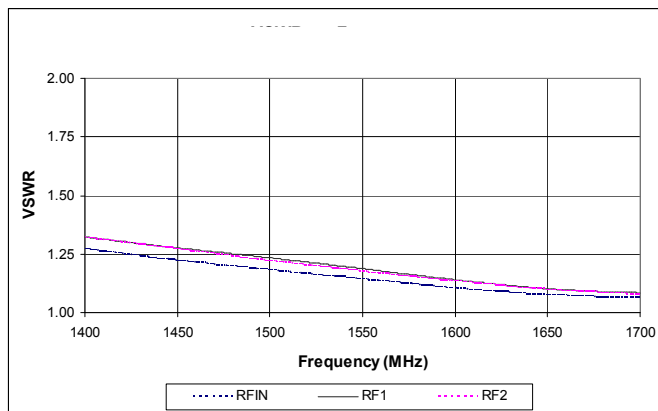

Phase Balance vs. Frequency

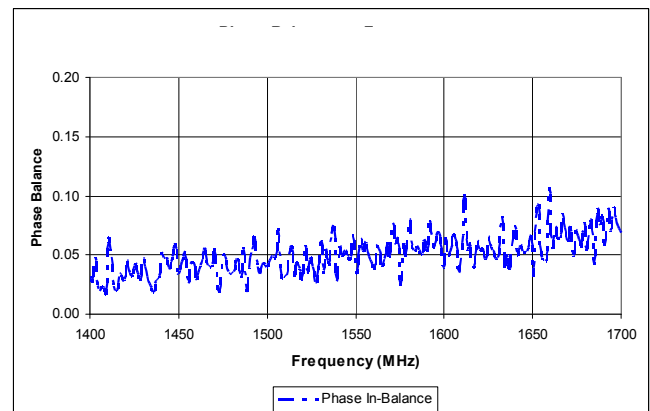

**Low Cost Two-Way SMT Power Divider
1510-1600 MHz**

**MAPDCC0003
V2**

Lead-Free, SOIC-8[†]

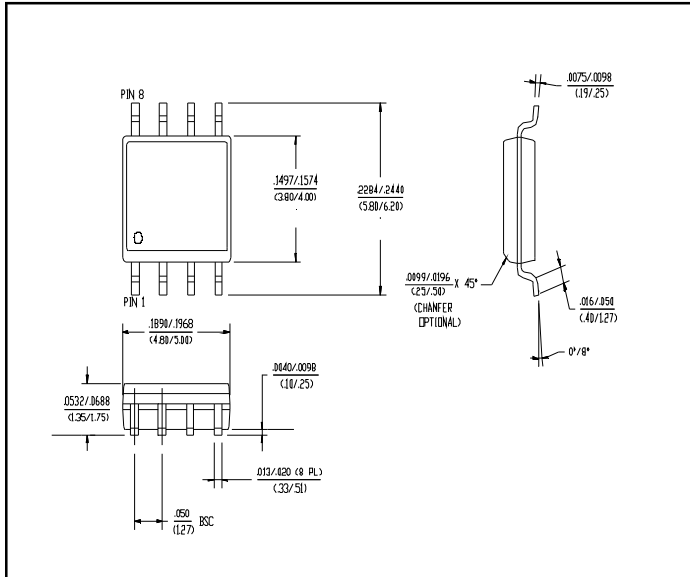

[†] Reference Application Note M538 for lead-free solder reflow recommendations.