

**2 Watt Packaged Amplifier**

**TGA2902-SCC-SG**



**Preliminary Measured Performance**

Bias Conditions:  $V_D = 7.5V$ ,  $I_D = 650mA$

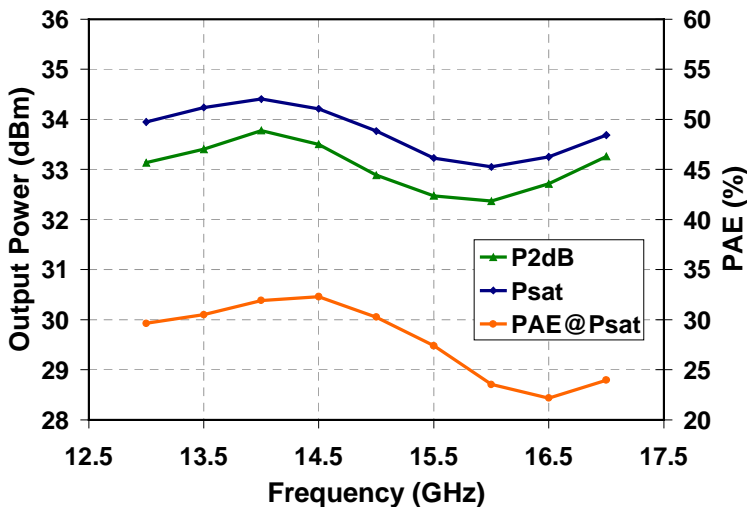
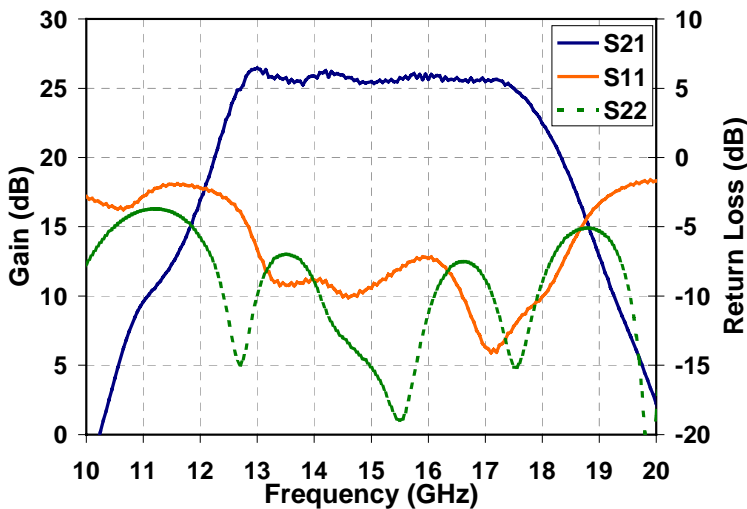

**Key Features and Performance**

- 34 dBm Midband Psat
- 26 dB Nominal Gain
- 8 dB Typical Return Loss
- 13 - 17 GHz Frequency Range
- Directional Power Detector with Reference
- 0.25µm pHEMT Technology
- Bias Conditions: 7.5V, 650mA
- Package Dimensions: 9.4 x 6.4 x 1.8 mm (370 x 250 x 71 mils)
- Lead free and RoHS Compliant

**Primary Applications**

- VSAT
- Point to Point

**TABLE I  
MAXIMUM RATINGS**

Symbol	Parameter	Value	Notes
$V_D$	Drain Voltage	8 V	<u>1/</u> <u>2/</u>
$V_G$	Gate Voltage Range	-5V to 0V	<u>1/</u>
$I_D$	Drain Supply Current (Quiescent)	1300 mA	<u>1/</u> <u>2/</u>
$ I_G $	Gate Supply Current	18 mA	<u>1/</u>
$P_{IN}$	Input Continuous Wave Power	24 dBm	<u>1/</u> <u>2/</u>
$P_D$	Power Dissipation	6.15 W	<u>1/</u> <u>2/</u> <u>3/</u>
$T_{CH}$	Operating Channel Temperature	150 °C	<u>4/</u>
$T_M$	Mounting Temperature (30 Seconds)	220 °C	
$T_{STG}$	Storage Temperature	-65 to 150 °C	

- 1/ These ratings represent the maximum operable values for this device
- 2/ Combinations of supply voltage, supply current, input power, and output power shall not exceed  $P_D$  at a package base temperature of 70°C
- 3/ When operated at this bias condition with a baseplate temperature of 70°C, the MTTF is reduced from 4.8E+6 to 1.0E+6 hours
- 4/ Junction operating temperature will directly affect the device median time to failure (MTTF). For maximum life, it is recommended that junction temperatures be maintained at the lowest possible levels.

**TABLE II  
THERMAL INFORMATION**

Parameter	Test Conditions	$T_{CH}$ (°C)	$R_{\theta JC}$ (°C/W)	MTTF (hrs)
$R_{\theta JC}$ Thermal Resistance (Channel to Backside of Package)	$V_D = 7.5V$ $I_D = 650mA$ $P_{DISS} = 4.88W$ $T_{BASE} = 70^\circ C$	132.3	12.8	4.8E+6

**TABLE III**  
**TGA2902-1-SCC-SG RF CHARACTERIZATION TABLE**  
 (T<sub>A</sub> = 25°C, Nominal)  
 (V<sub>d</sub> = 7.5V, I<sub>d</sub> = 650mA ±5%)

Symbol	Parameter	Test Conditions	Limits			Units	Notes
			Min	Typ	Max		
Gain	Small Signal Gain	F = 13-17	22	26	29	dB	<u>1/</u> <u>2/</u>
IRL	Input Return Loss	F = 13-17		8		dB	
ORL	Output Return Loss	F = 13-17		8		dB	
PSAT	Output Power @ Pin = +14dBm	F = 13-17	32.5	33.5		dBm	<u>1/</u>
P2dB	Output Power @ 2dB Gain Compression	F = 13-17		32.5		dBm	
I <sub>D</sub>	Drain Current @ Pin = +14dBm	F = 13-17		1100	1300	mA	
I <sub>G</sub>	Gate Current @ Pin = +14dBm	F = 13-17		6	18	mA	
IP3	Third Order Intercept Point	F = 13-17		38		dBm	
PAE	Power Added Efficiency @ Pin = +14dBm	F = 13-17		30		%	

Note: Table IV Lists the RF Characteristics of typical devices as determined by fixtured measurements.

1/ Data taken at 500MHz steps

2/ Maximum Pin = -10dBm

**TABLE IV**  
**TGA2902-2-SCC-SG RF CHARACTERIZATION TABLE**  
 (T<sub>A</sub> = 25°C, Nominal)  
 (V<sub>d</sub> = 7.5V, I<sub>d</sub> = 650mA ±5%)

Symbol	Parameter	Test Conditions	Limits			Units	Notes
			Min	Typ	Max		
Gain	Small Signal Gain	F = 13.75-14.5	23	26	29	dB	<u>1/</u> <u>2/</u>
IRL	Input Return Loss	F = 13.75-14.5		8		dB	
ORL	Output Return Loss	F = 13.75-14.5		8		dB	
PSAT	Output Power @ Pin = +14dBm	F = 13.75-14.5	33.5	34.0		dBm	<u>1/</u>
P2dB	Output Power @ 2dB Gain Compression	F = 13.75-14.5		33.5		dBm	
I <sub>D</sub>	Drain Current @ Pin = +14dBm	F = 13.75-14.5		1100	1300	mA	
I <sub>G</sub>	Gate Current @ Pin = +14dBm	F = 13.75-14.5		6	18	mA	
IP3	Third Order Intercept Point	F = 13.75-14.5		38.5		dBm	
PAE	Power Added Efficiency @ Pin = +14dBm	F = 13.75-14.5		30		%	

Note: Table III Lists the RF Characteristics of typical devices as determined by fixtured measurements.

1/ Data taken at 250MHz steps

2/ Maximum Pin = -10dBm

Typical Fixtured Performance

Vd=7.5V, Idq=650mA

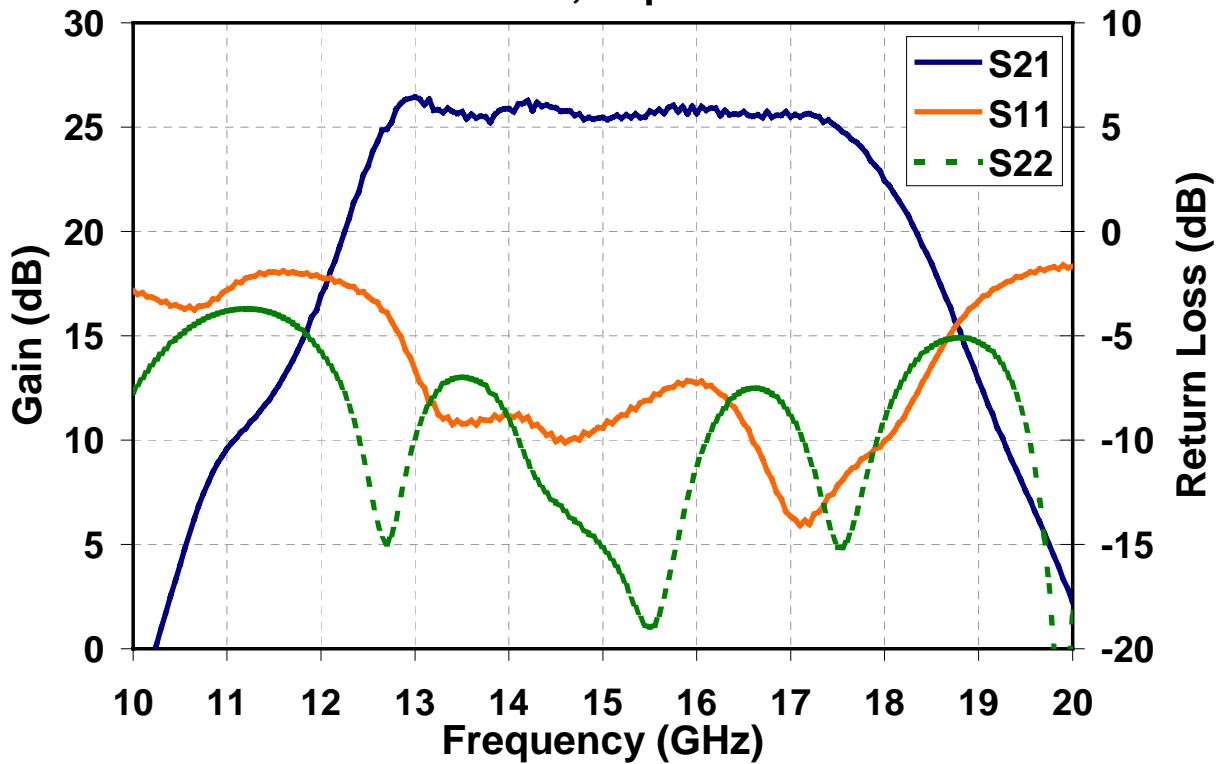

Vd=7.5V, Idq=650mA

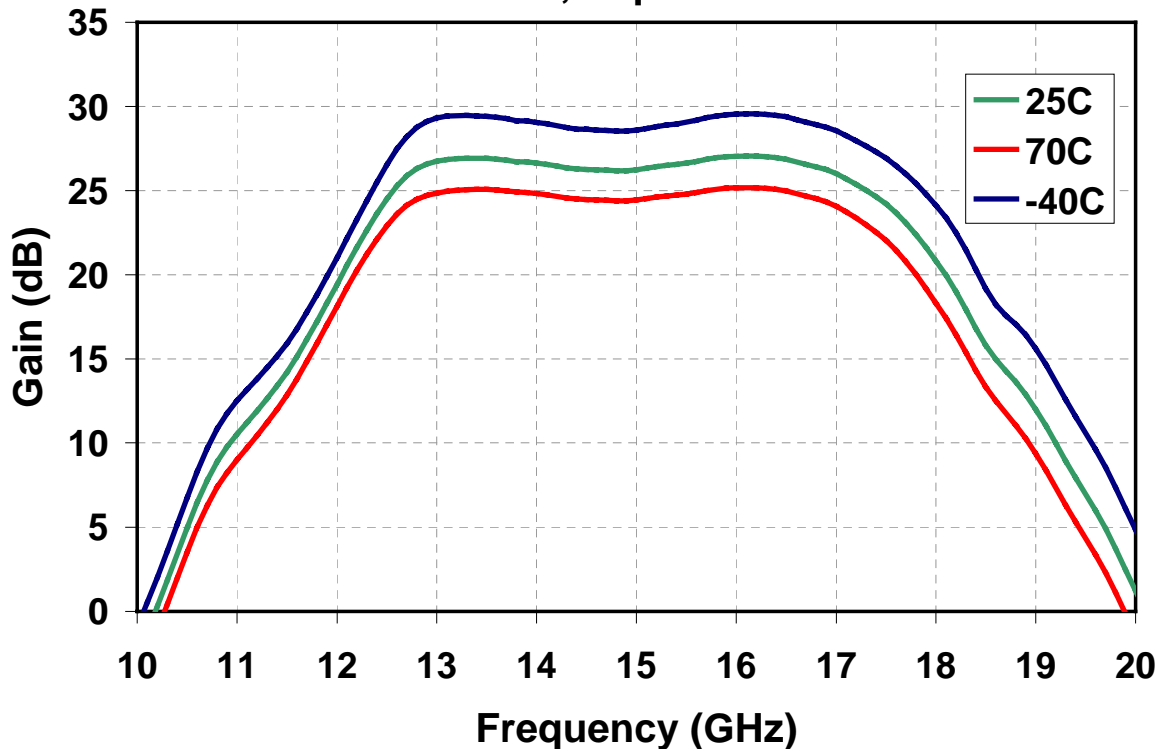

Typical Fixtured Performance

Vd=5V, Idq=650mA

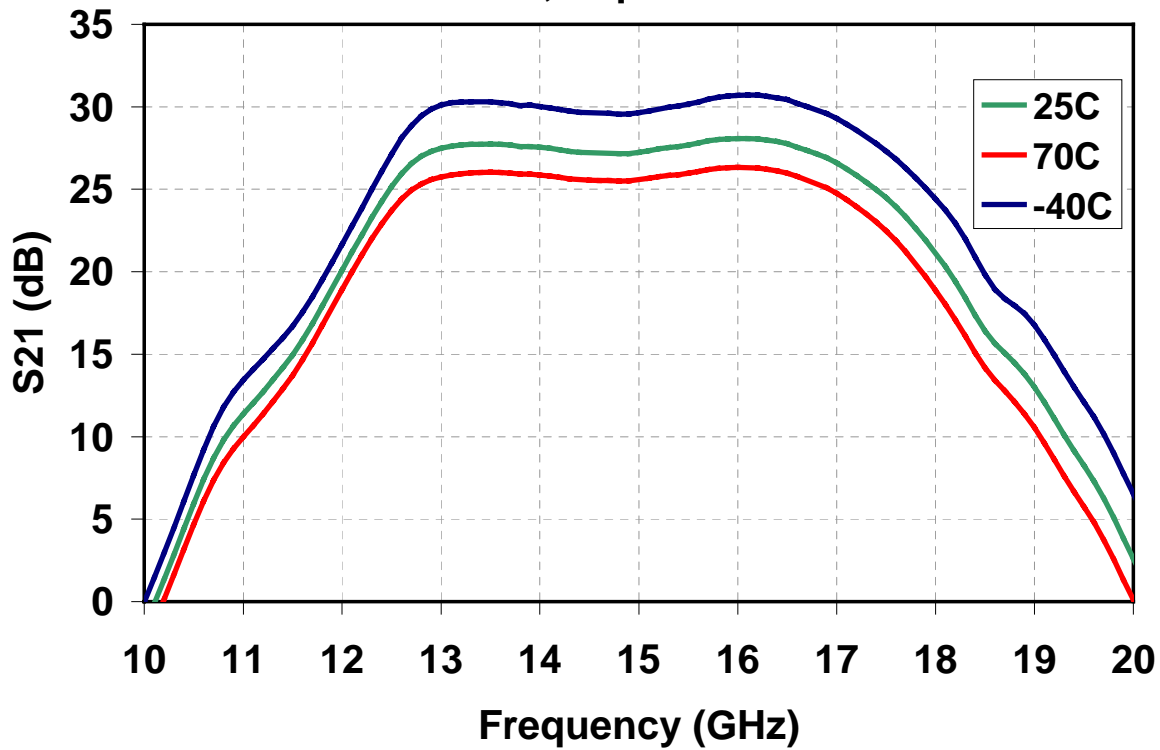

Vd=7.5V, Idq=650mA

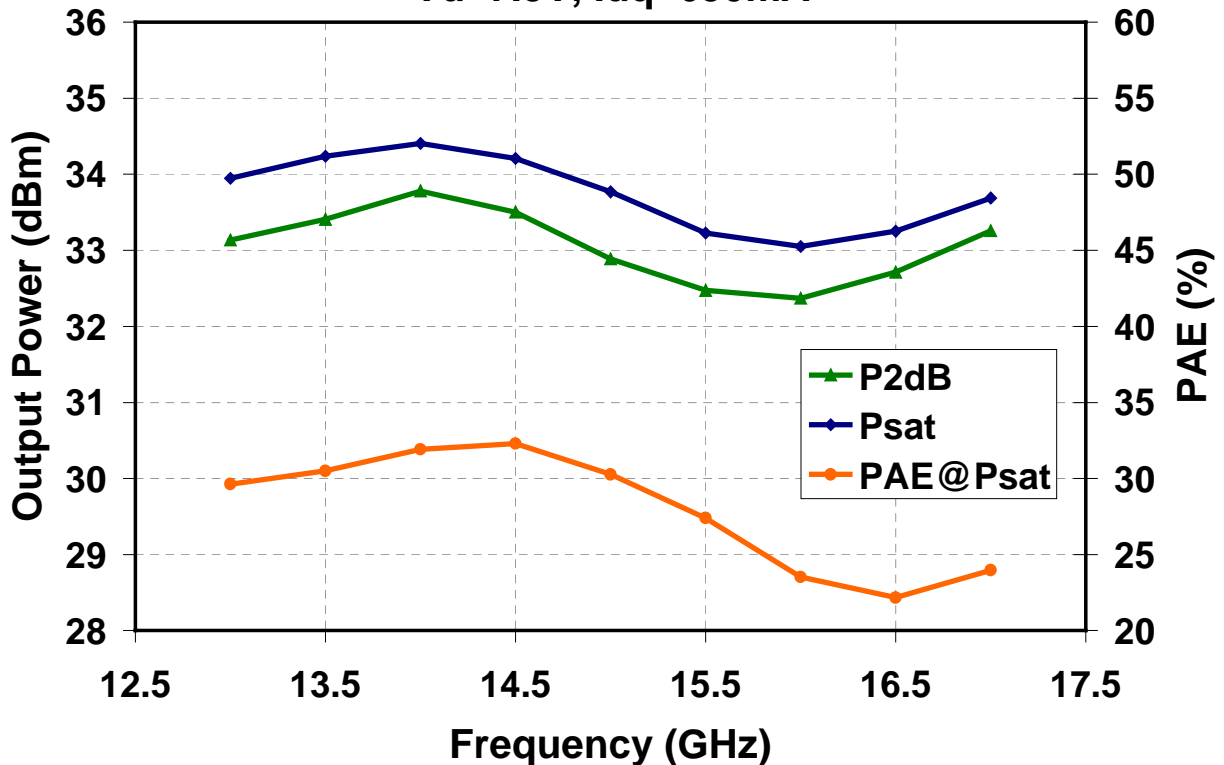

Typical Fixtured Performance

Vd=7.5V, Idq=650mA, f=14GHz

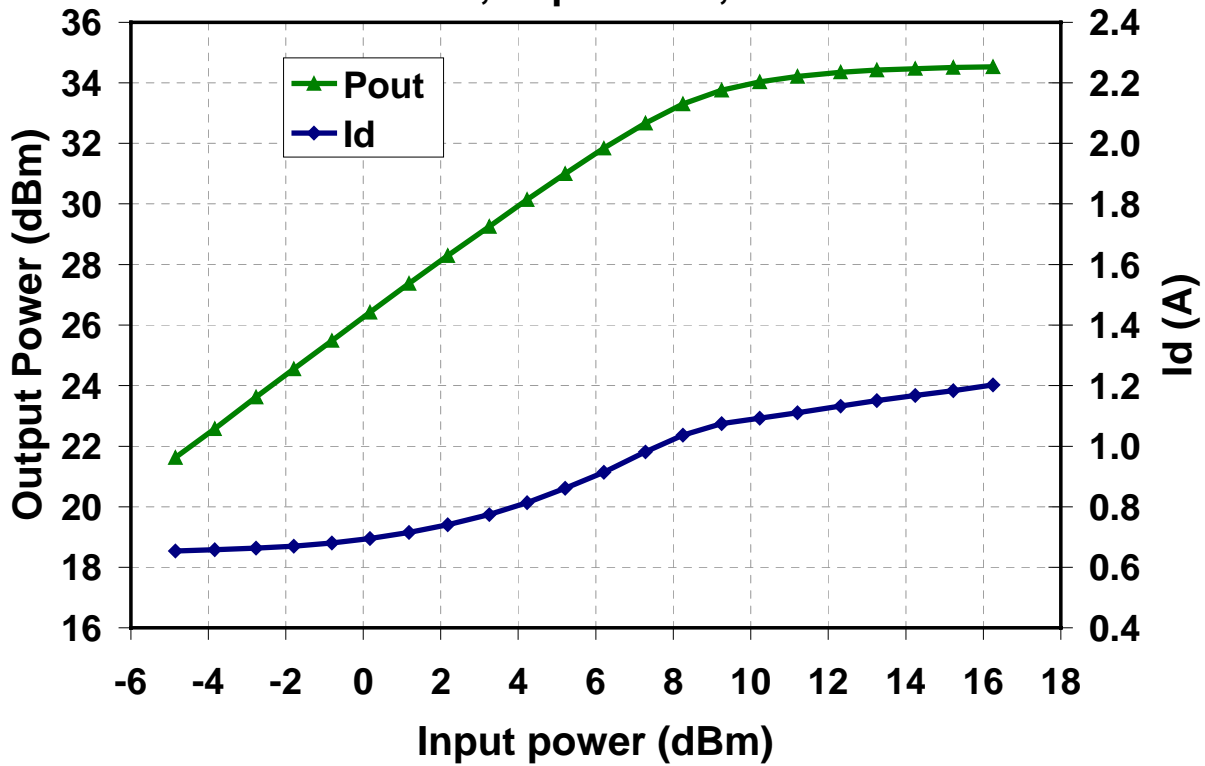

Vd=5V, Idq=650mA

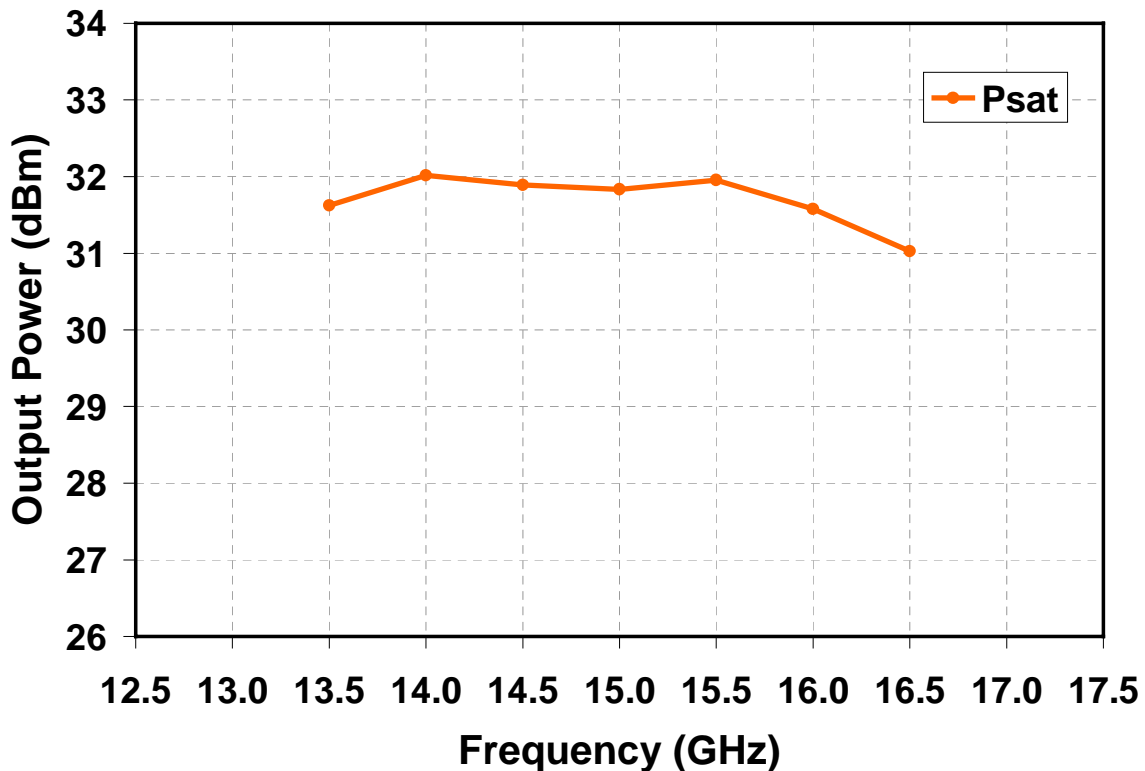

Typical Fixtured Performance

Vd=5V, Idq=650mA, f=14GHz

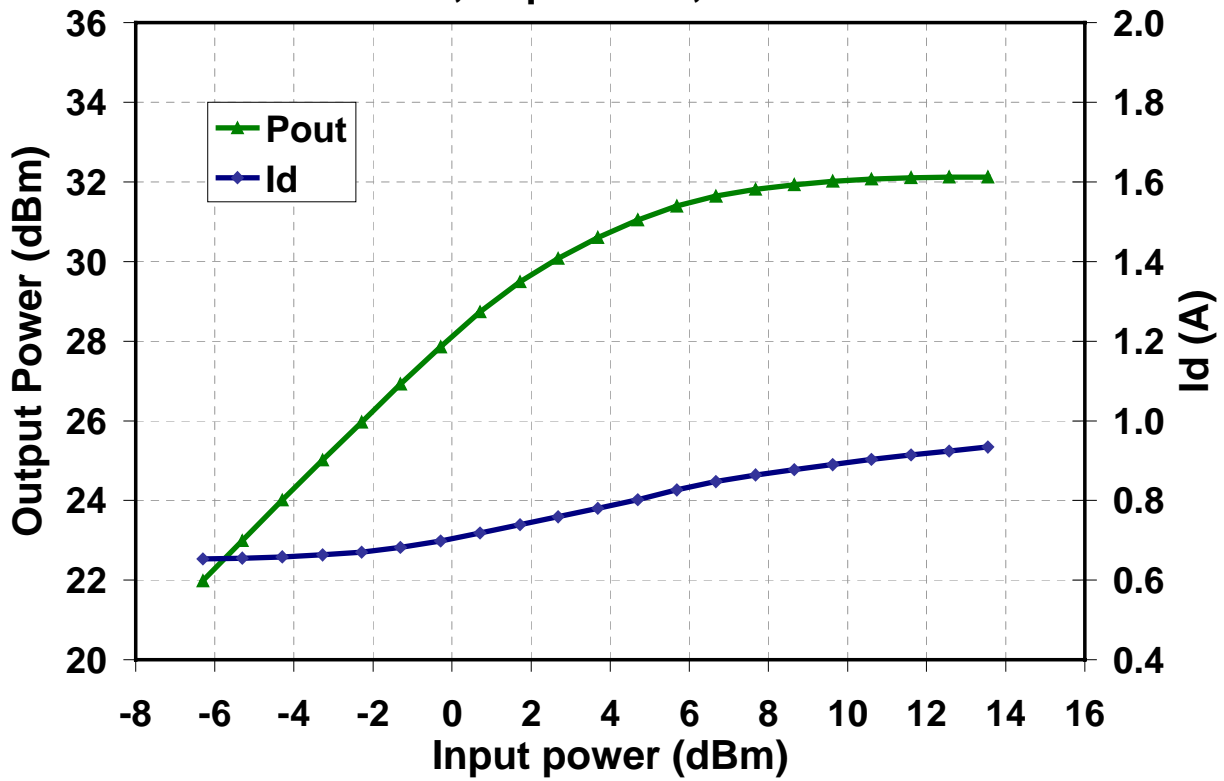

Vd=7.5V, Idq=650mA

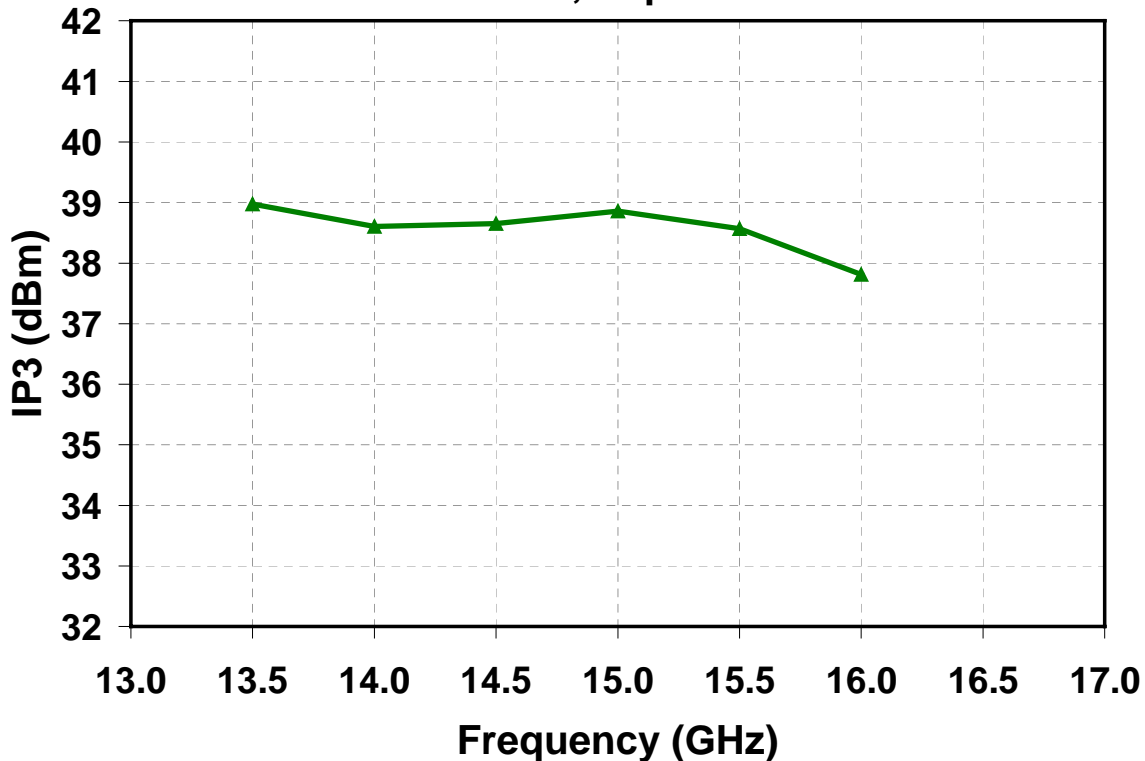



Typical Fixtured Performance

Vd=7.5V, Id=650mA

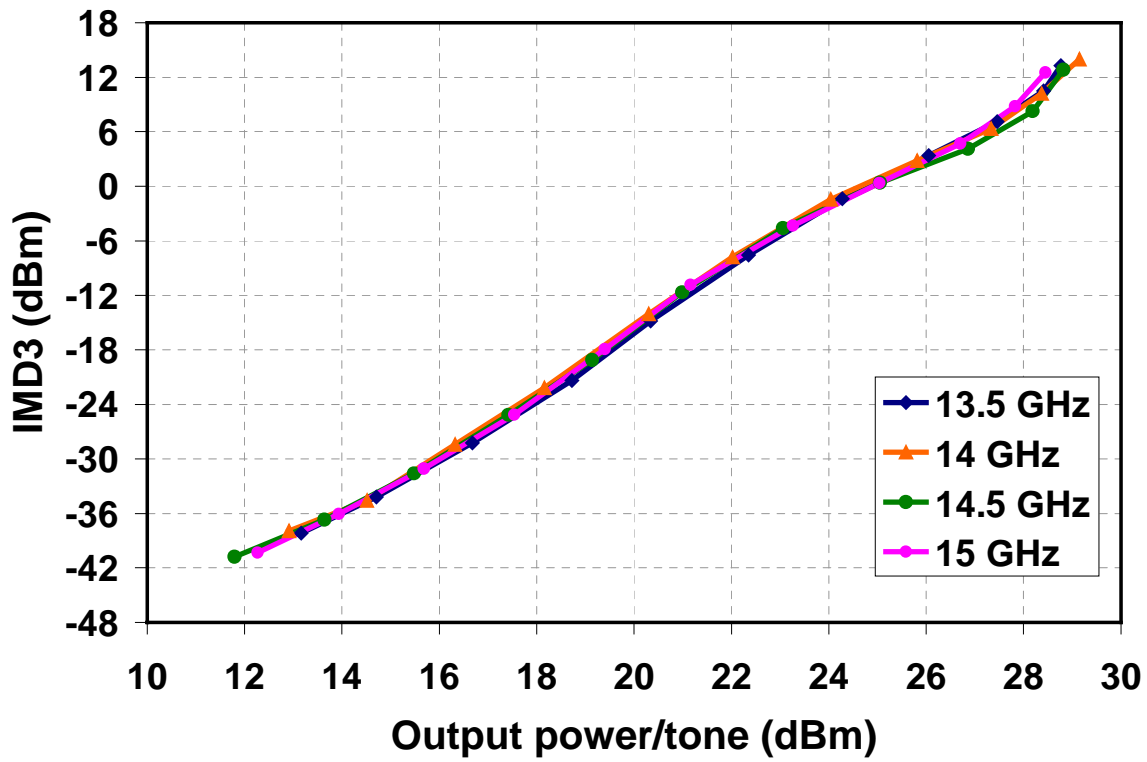

**Power Detector**

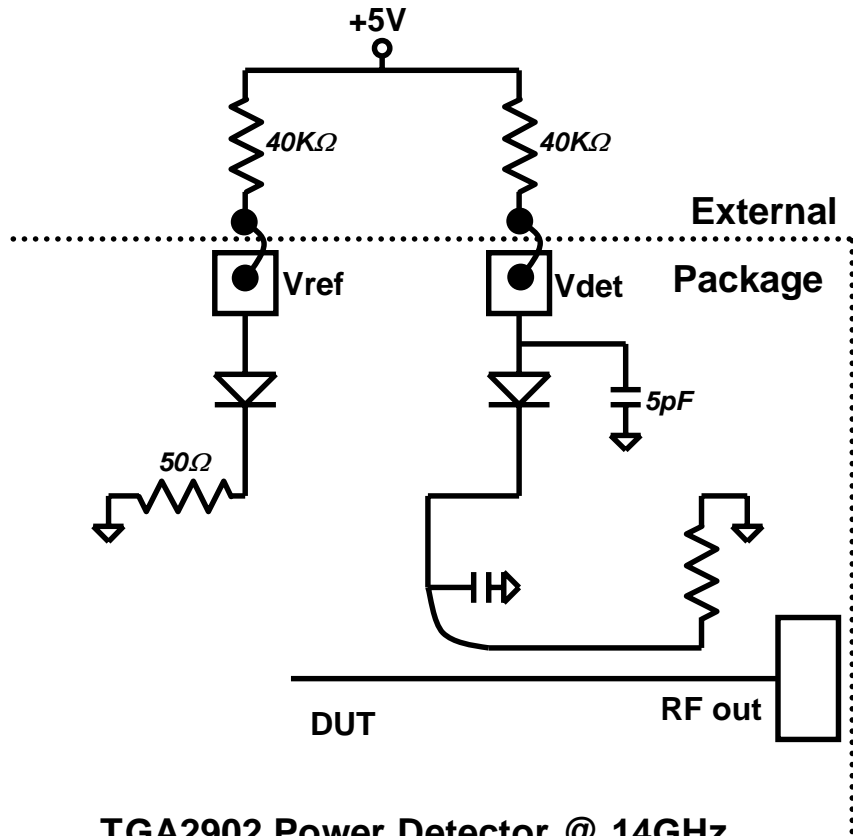

**TGA2902 Power Detector @ 14GHz**

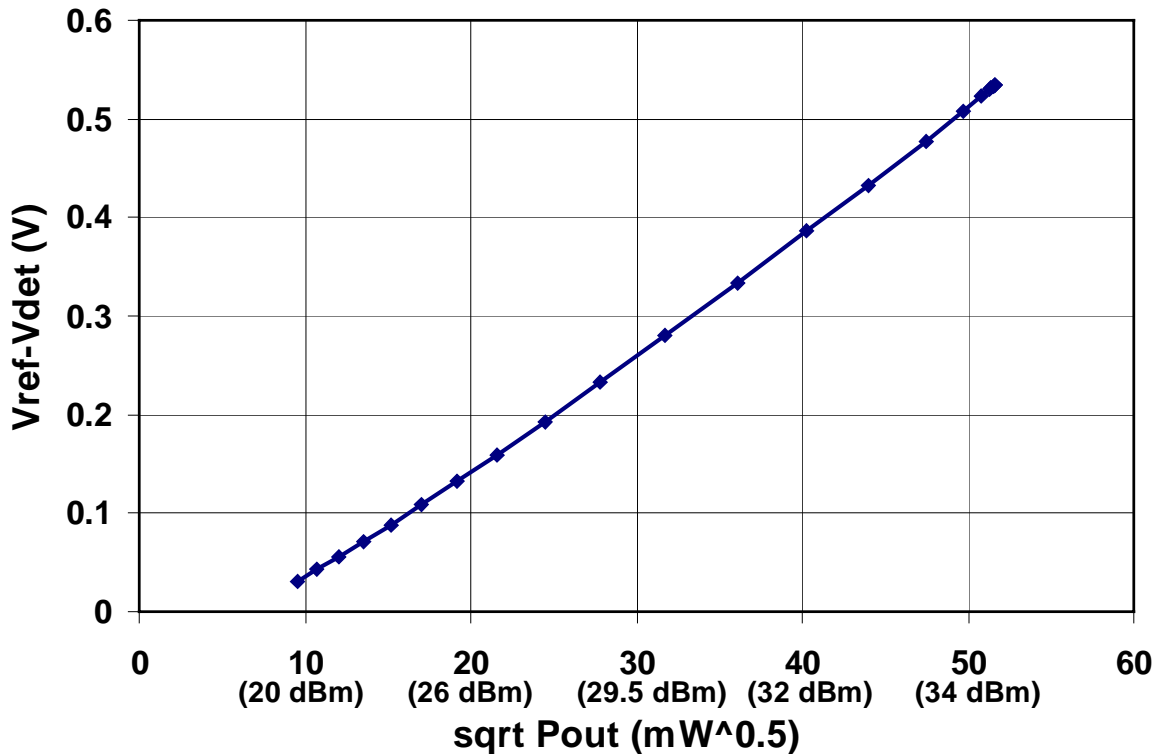

### Package Pinout Diagram

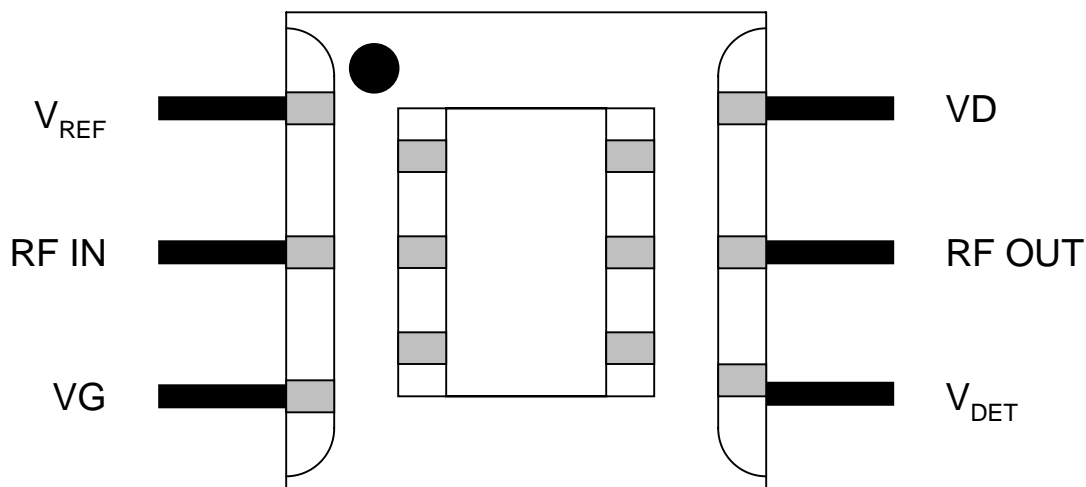

***GaAs MMIC devices are susceptible to damage from Electrostatic Discharge. Proper precautions should be observed during handling, assembly and test.***

**Mechanical Drawing**

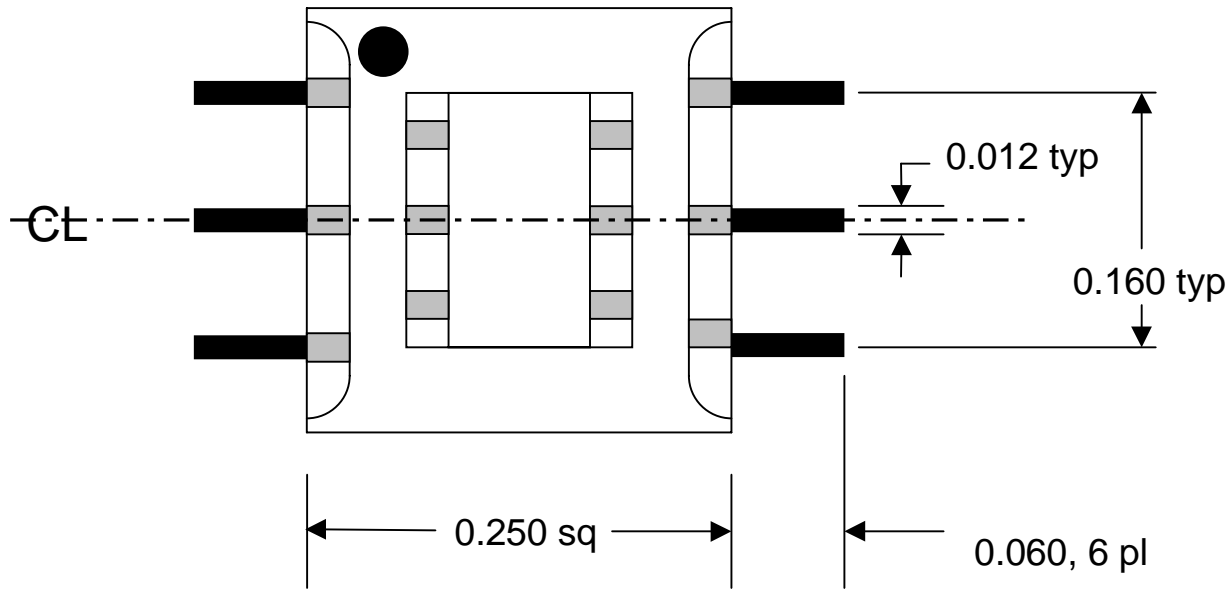

Top View

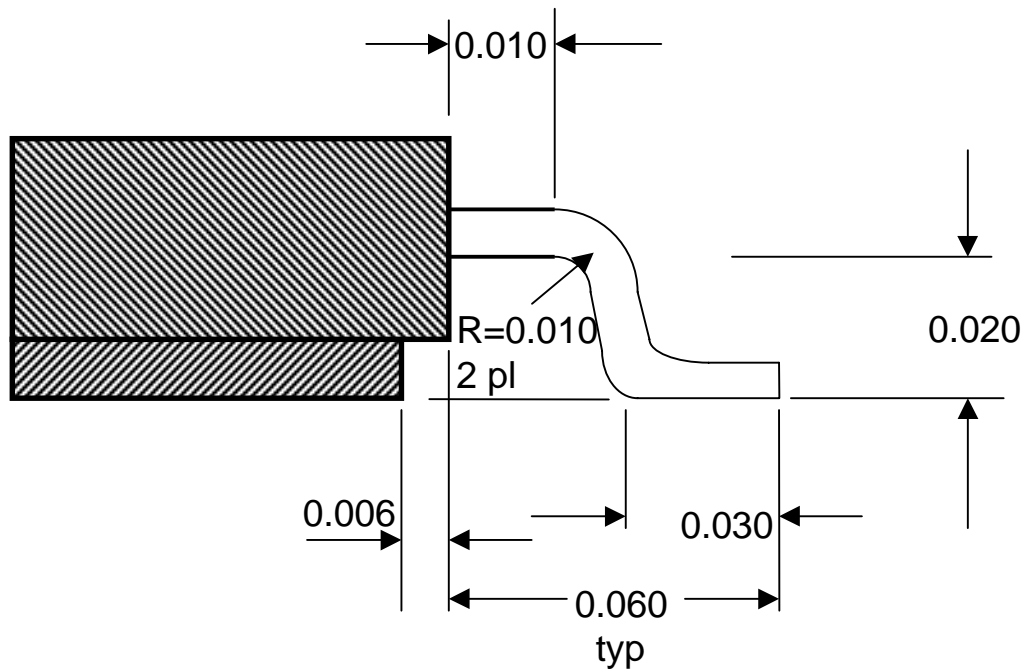

Side View

**Dimensions in inches**  
**Lead planarity is +0.006/-0.002**

**Recommended PWB Land Pattern**

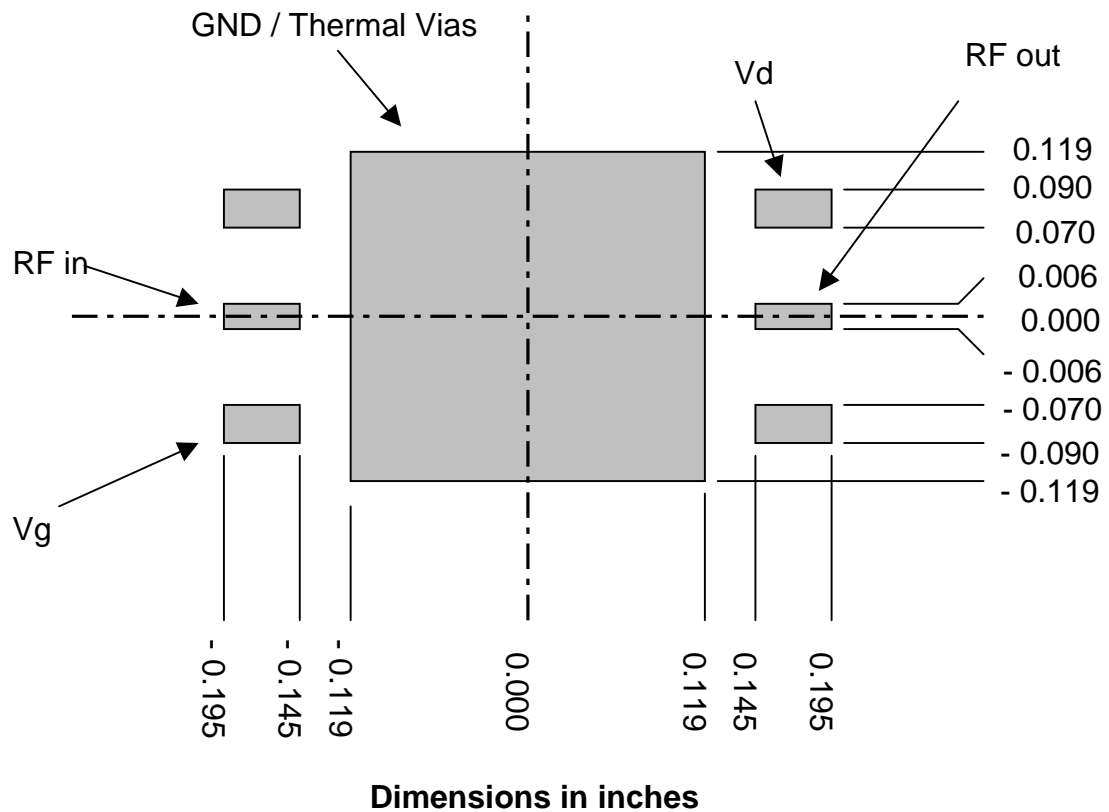

## Recommended Surface Mount Package Assembly

Proper ESD precautions must be followed while handling packages.

Clean the board with acetone. Rinse with alcohol. Allow the circuit to fully dry.

TriQuint recommends using a conductive solder paste for attachment. Follow solder paste and reflow oven vendors' recommendations when developing a solder reflow profile. Typical solder reflow profiles are listed in the table below.

Hand soldering is not recommended. Solder paste can be applied using a stencil printer or dot placement. The volume of solder paste depends on PCB and component layout and should be well controlled to ensure consistent mechanical and electrical performance.

Clean the assembly with alcohol.

## Typical Solder Reflow Profiles

Reflow Profile	SnPb	Pb Free
Ramp-up Rate	3 °C/sec	3 °C/sec
Activation Time and Temperature	60 – 120 sec @ 140 – 160 °C	60 – 180 sec @ 150 – 200 °C
Time above Melting Point	60 – 150 sec	60 – 150 sec
Max Peak Temperature	240 °C	260 °C
Time within 5 °C of Peak Temperature	10 – 20 sec	10 – 20 sec
Ramp-down Rate	4 – 6 °C/sec	4 – 6 °C/sec

## Ordering Information

PART NUMBER	AMPLIFIER APPLICATION
TGA2902-1-SCC-SG	Wideband
TGA2902-2-SCC-SG	VSAT Band

Tape & Reel in increments of 500 pcs, specify "T&R" after the part number: TGA2902-1-SCC-SG T&R.

***GaAs MMIC devices are susceptible to damage from Electrostatic Discharge. Proper precautions should be observed during handling, assembly and test.***