

Ku Band 2 Watt Packaged Amplifier

TGA2510-EPU-SG



Key Features and Performance

- 33.5 dBm Midband Psat
- 25 dB Nominal Gain
- 7 dB Typical Input Return Loss
- 10 dB Typical Output Return Loss
- 12.5 - 17 GHz Frequency Range
- Directional Power Detector with Reference
- 0.25µm pHEMT 3MI Technology
- Bias Conditions: 7.5V, 650mA
- Package Dimensions:
9.4 x 6.4 x 1.8 mm
(0.370 x 0.250 x 0.071 inches)

Preliminary Measured Performance

Bias Conditions: Vd=7.5V Id=650mA

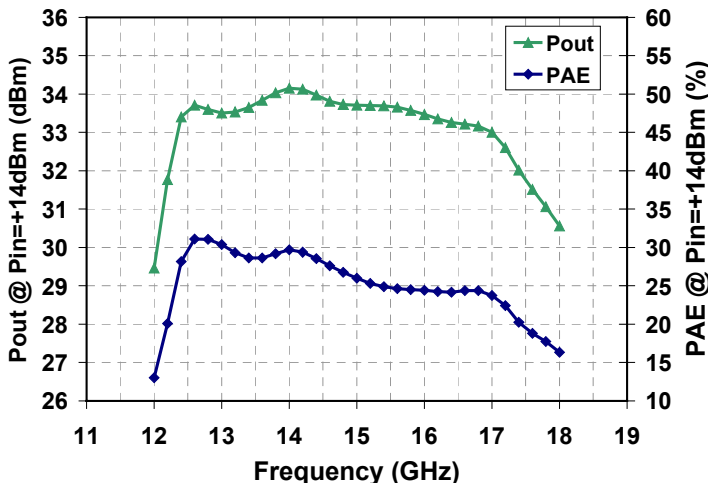
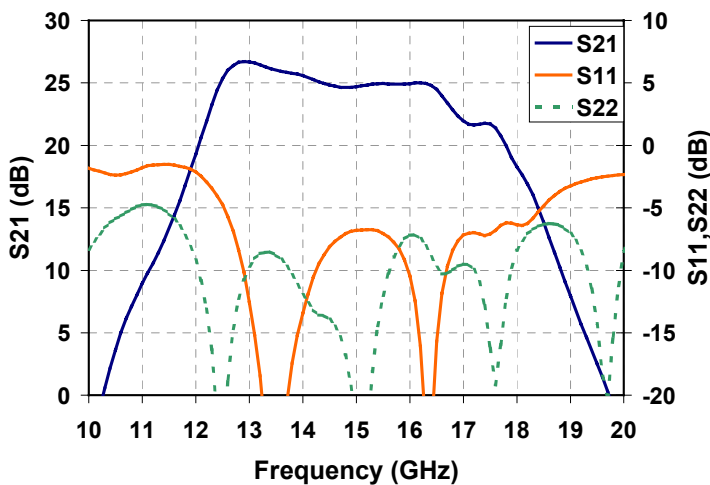

Note: Devices designated as EPU are typically early in their characterization process prior to finalizing all electrical and process specifications. Specifications are subject to change without notice.

Primary Applications

- VSAT
- Point to Point

**TABLE I
MAXIMUM RATINGS**

Symbol	Parameter	Value	Notes
V _D	Drain Voltage	8 V	<u>1/</u> <u>2/</u>
V _G	Gate Voltage Range	-5V to 0V	<u>1/</u>
I _D	Drain Supply Current (Quiescent)	1300 mA	<u>1/</u> <u>2/</u>
I _G	Gate Supply Current	18 mA	<u>1/</u>
P _{IN}	Input Continuous Wave Power	24 dBm	<u>1/</u> <u>2/</u>
P _D	Power Dissipation	6.15 W	<u>1/</u> <u>2/</u> <u>3/</u>
T _{CH}	Operating Channel Temperature	150 °C	<u>4/</u>
T _M	Mounting Temperature (30 Seconds)	320 °C	
T _{STG}	Storage Temperature	-65 to 150 °C	

- 1/ These ratings represent the maximum operable values for this device
- 2/ Combinations of supply voltage, supply current, input power, and output power shall not exceed P_D at a package base temperature of 70°C
- 3/ When operated at this bias condition with a baseplate temperature of 70°C, the MTTF is reduced to 1.0E+6 hours
- 4/ Junction operating temperature will directly affect the device median time to failure (MTTF). For maximum life, it is recommended that junction temperatures be maintained at the lowest possible levels.

**TABLE II
THERMAL INFORMATION**

Parameter	Test Conditions	T _{CH} (°C)	R _{θJC} (°C/W)	MTTF (hrs)
R _{θJC} Thermal Resistance (Channel to Backside of Package)	V _D = 7.5V I _D = 650mA P _{DISS} = 4.88W T _{BASE} = 70°C	132.3	12.8	4.8E+6

Note: Devices designated as EPU are typically early in their characterization process prior to finalizing all electrical and process specifications. Specifications are subject to change without notice.

TABLE III
RF CHARACTERIZATION TABLE
($T_A = 25^\circ\text{C}$, Nominal)
($V_d = 7.5\text{V}$, $I_d = 650\text{mA} \pm 5\%$)

Symbol	Parameter	Test Conditions	Typ	Units	Notes
Gain	Small Signal Gain	F = 12.5 – 16 GHz	25	dB	
IRL	Input Return Loss	F = 12.5 – 16 GHz	7	dB	
ORL	Output Return Loss	F = 12.5 – 16 GHz	10	dB	
PWR	Output Power @ Pin = +14dBm	F = 12.5 – 16 GHz	33.5	dBm	
PAE	Power Added Efficiency @ Pin = +14dBm	F = 12.5 – 16 GHz	29	%	

Note: Table III Lists the RF Characteristics of typical devices as determined by fixtured measurements.

Note: Devices designated as EPU are typically early in their characterization process prior to finalizing all electrical and process specifications. Specifications are subject to change without notice.

Typical Fixtured Performance TGA2510-EPU-SG
Id=650mA

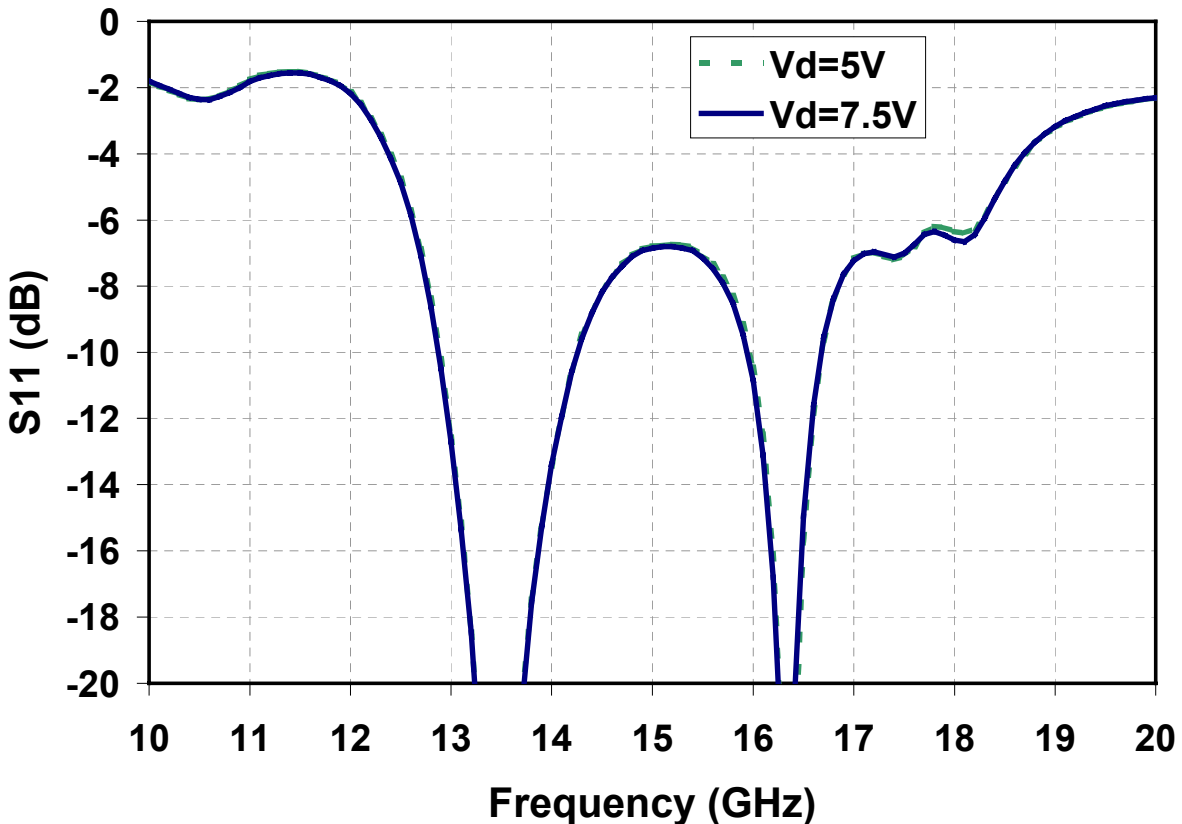
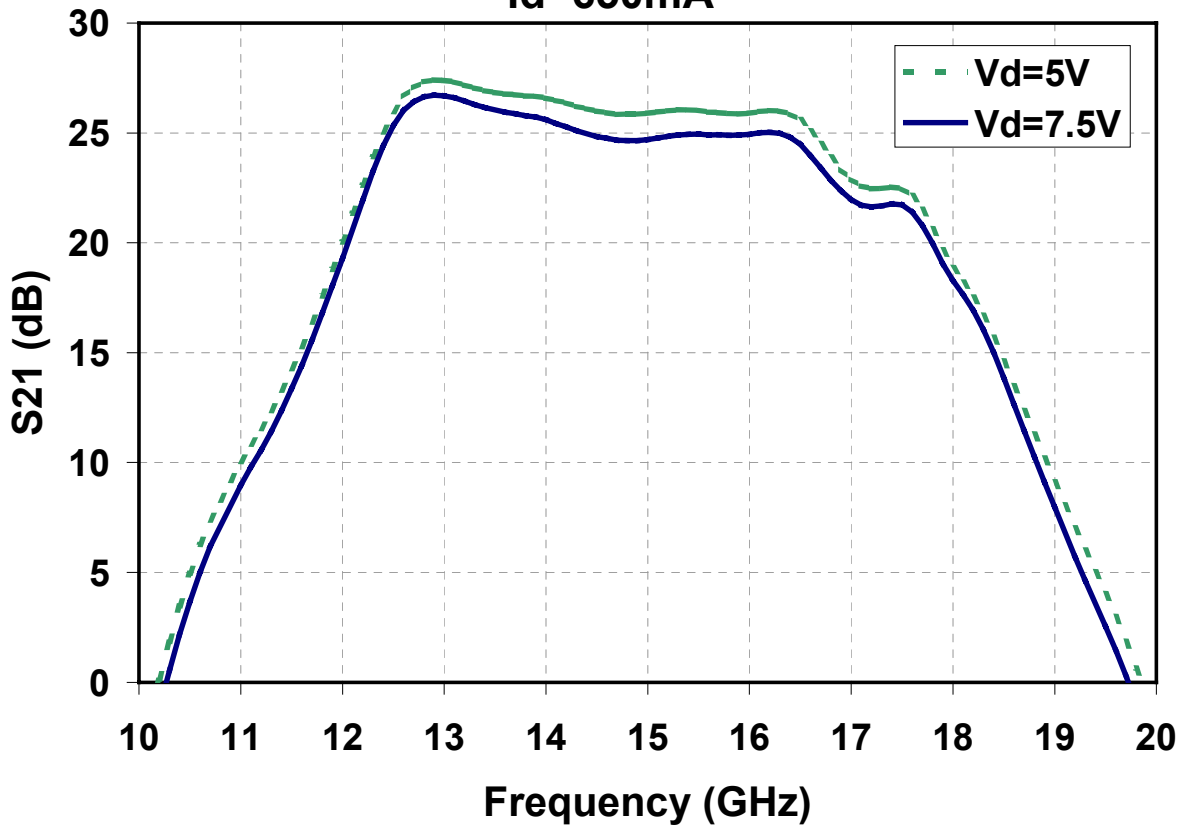

Note: Devices designated as EPU are typically early in their characterization process prior to finalizing all electrical and process specifications. Specifications are subject to change without notice.

Typical Fixtured Performance TGA2510-EPU-SG

$I_d=650\text{mA}$

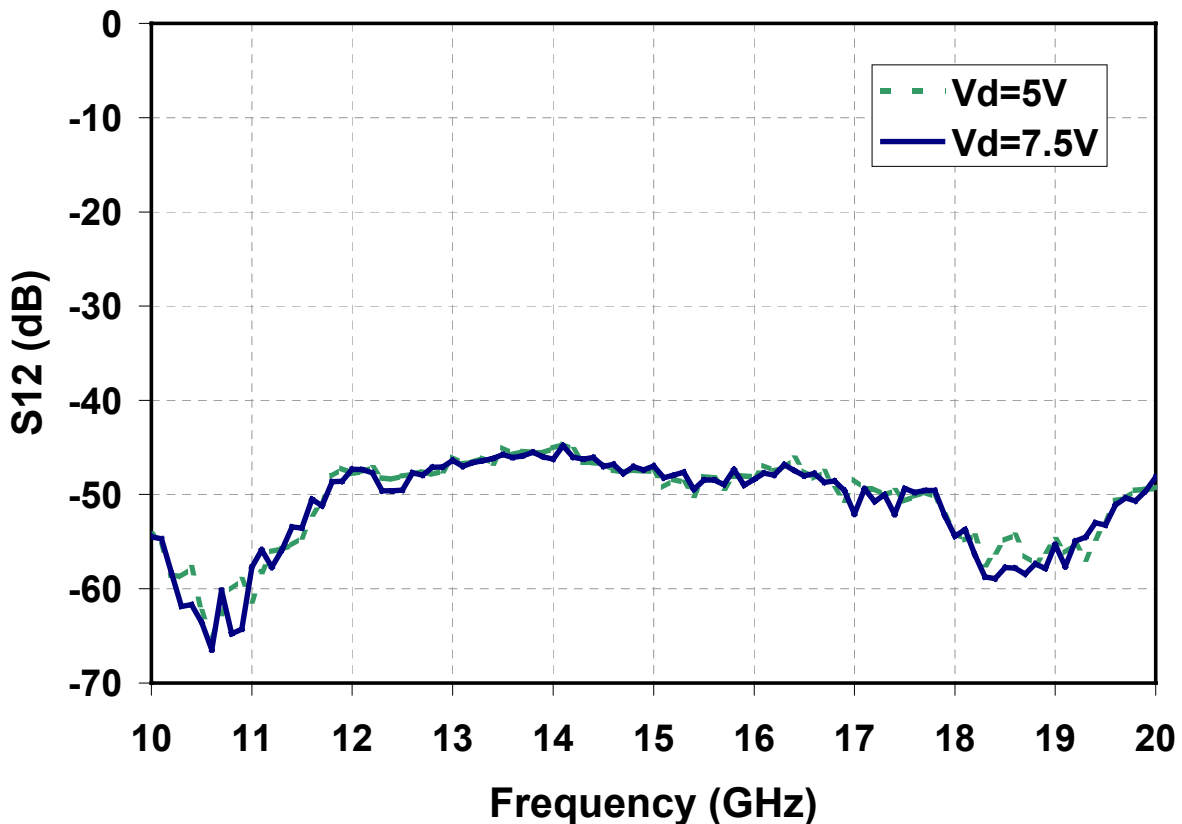
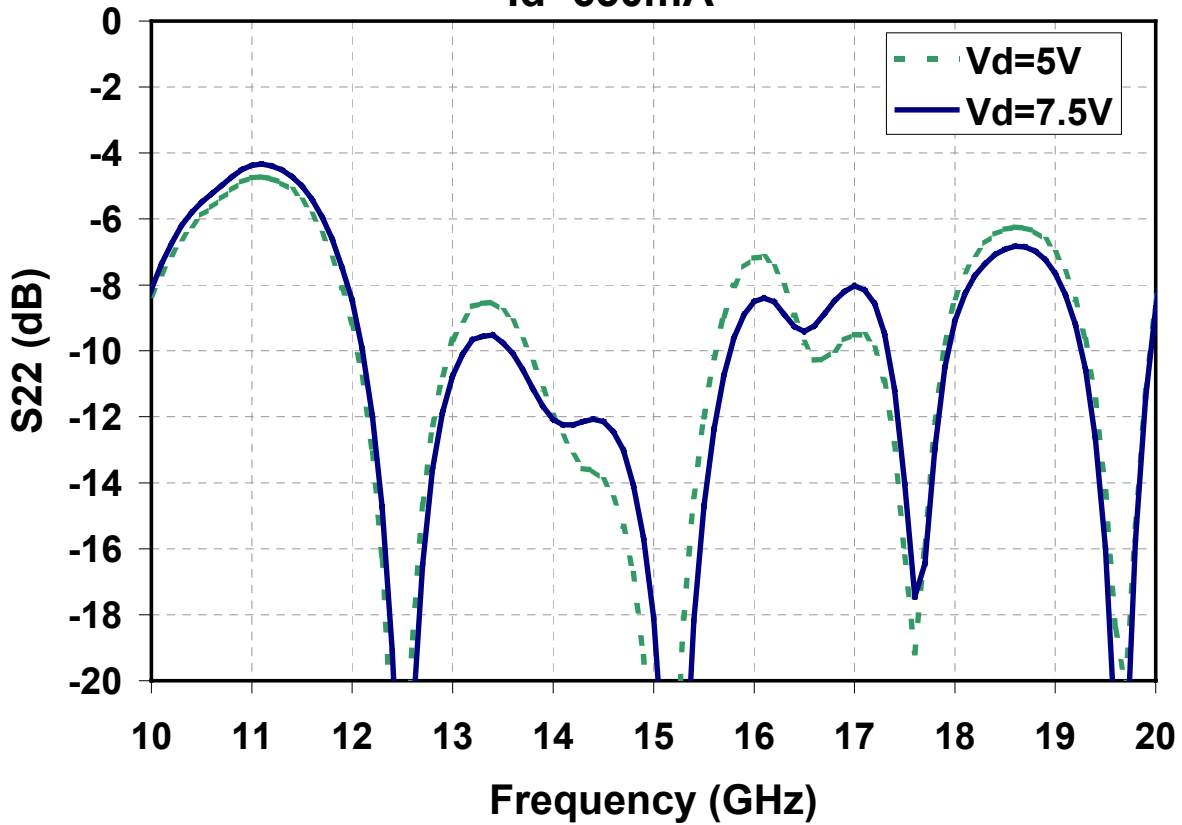

Note: Devices designated as EPU are typically early in their characterization process prior to finalizing all electrical and process specifications. Specifications are subject to change without notice.

Typical Fixtured Performance
Id=650mA

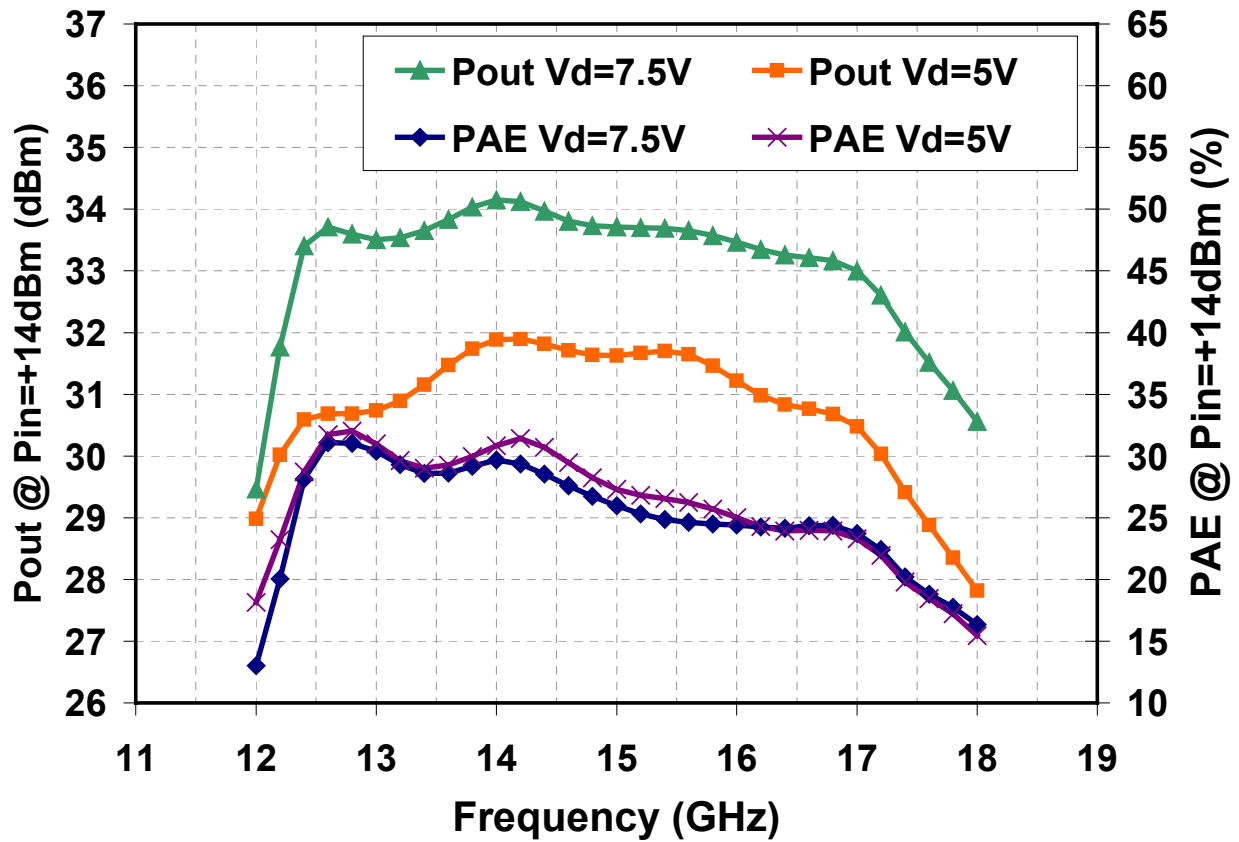

Note: Devices designated as EPU are typically early in their characterization process prior to finalizing all electrical and process specifications. Specifications are subject to change without notice.

Typical Fixtured Performance TGA2510-EPU-SG

$I_d=800mA$

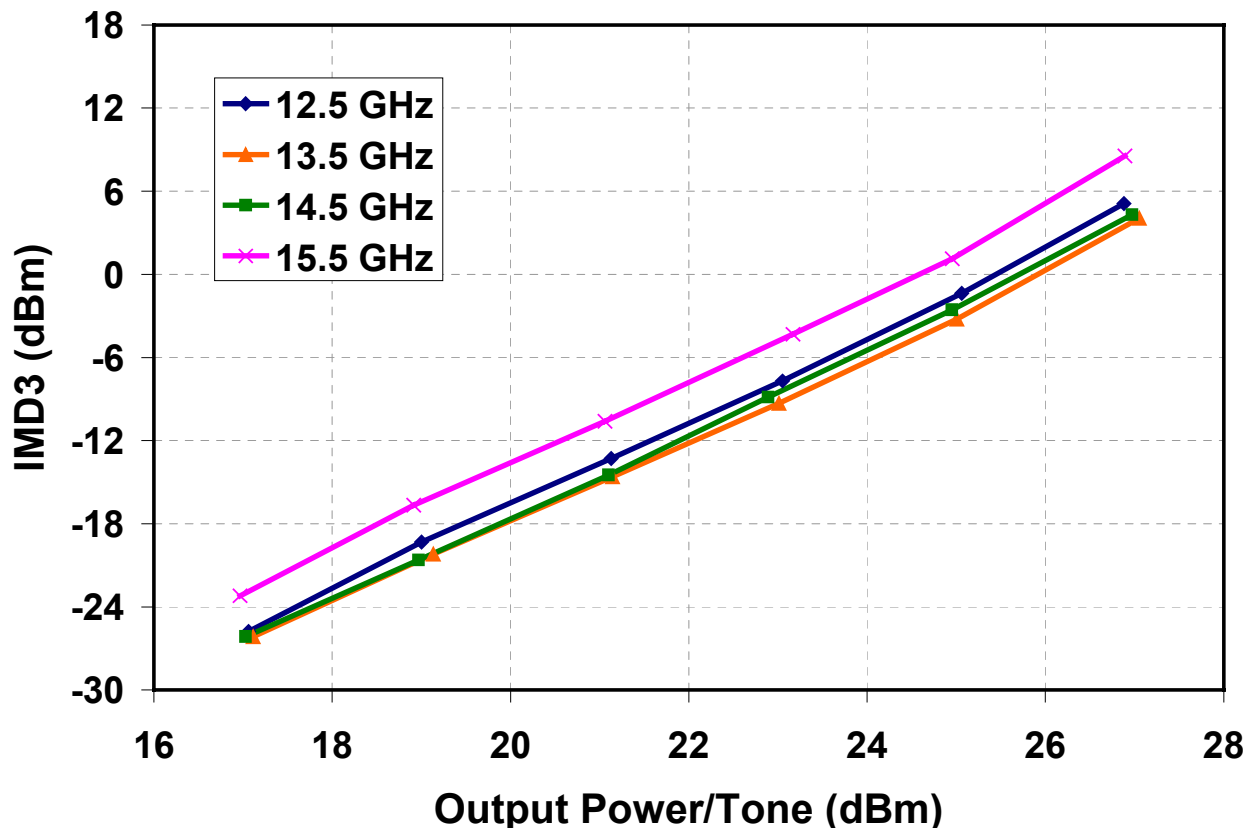
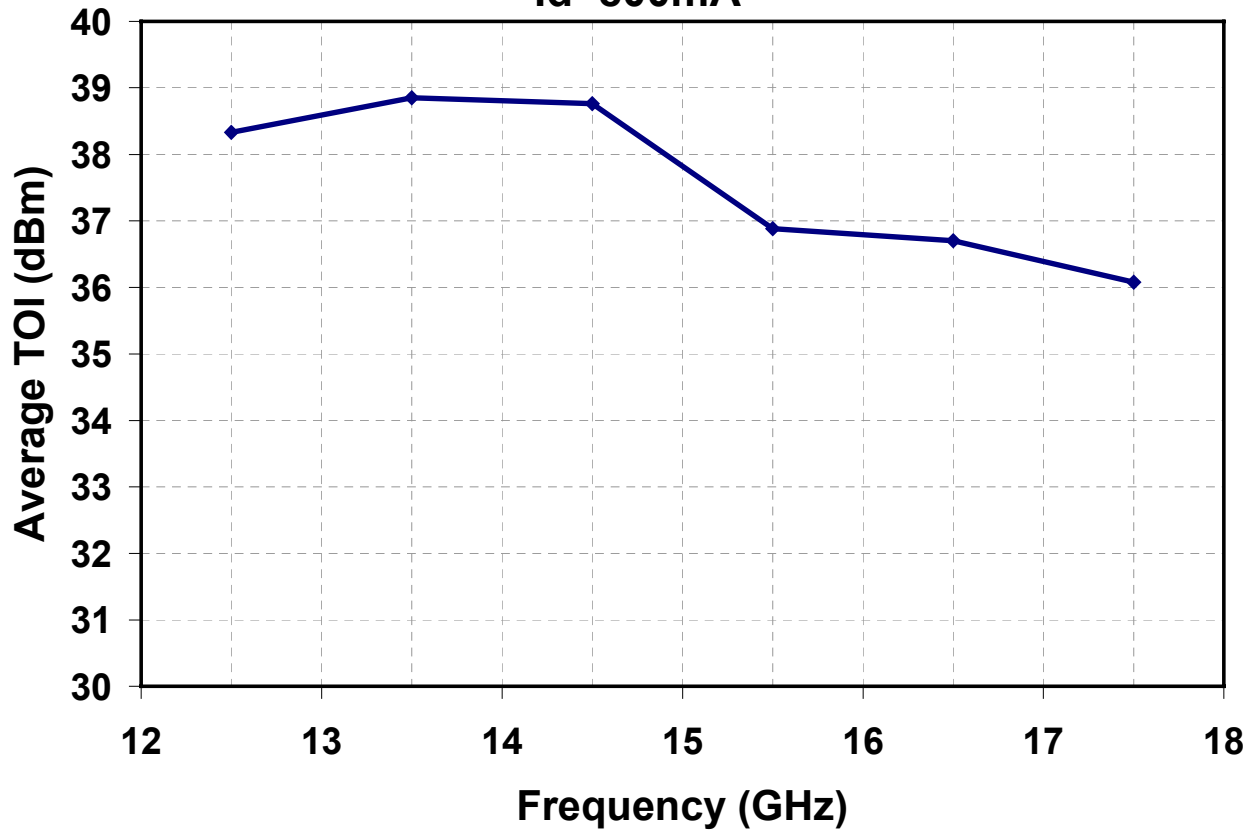

Note: Devices designated as EPU are typically early in their characterization process prior to finalizing all electrical and process specifications. Specifications are subject to change without notice.

Package Pinout Diagram

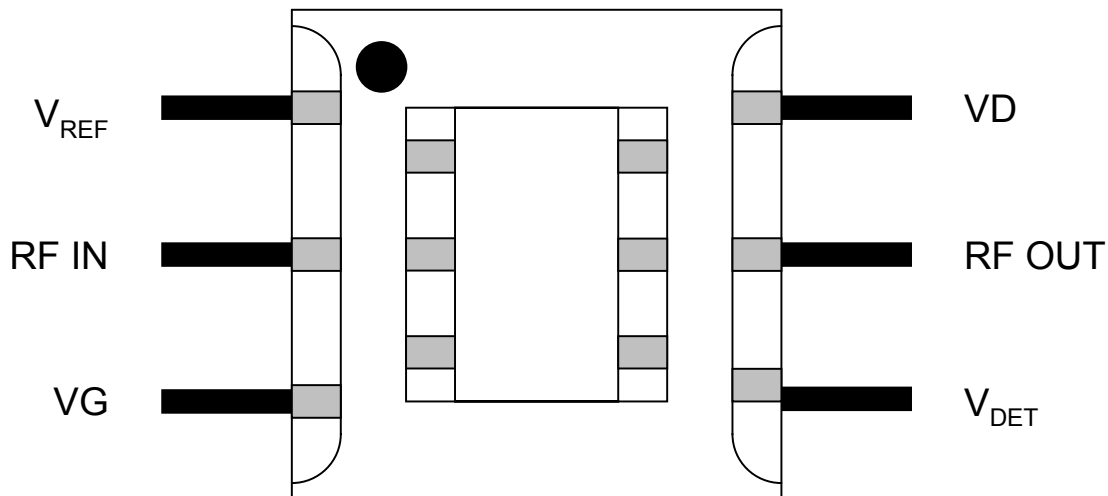

Package Assembly Diagram

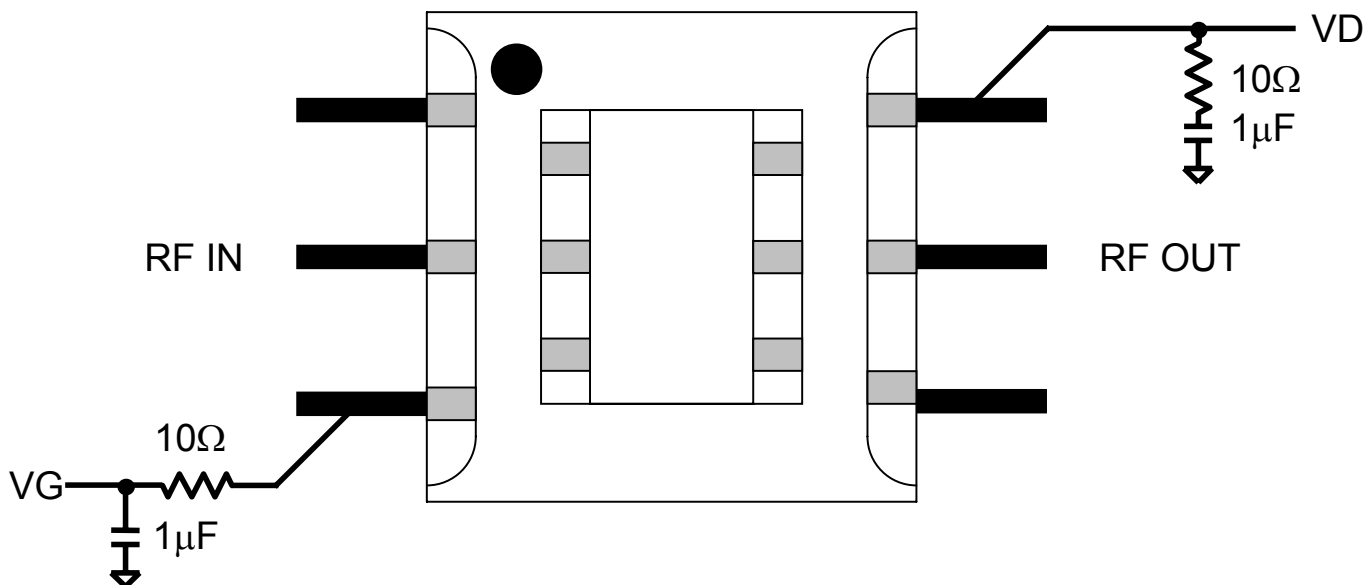

GaAs MMIC devices are susceptible to damage from Electrostatic Discharge. Proper precautions should be observed during handling, assembly and test.

Note: Devices designated as EPU are typically early in their characterization process prior to finalizing all electrical and process specifications. Specifications are subject to change without notice.

Mechanical Drawing

Dimensions in inches

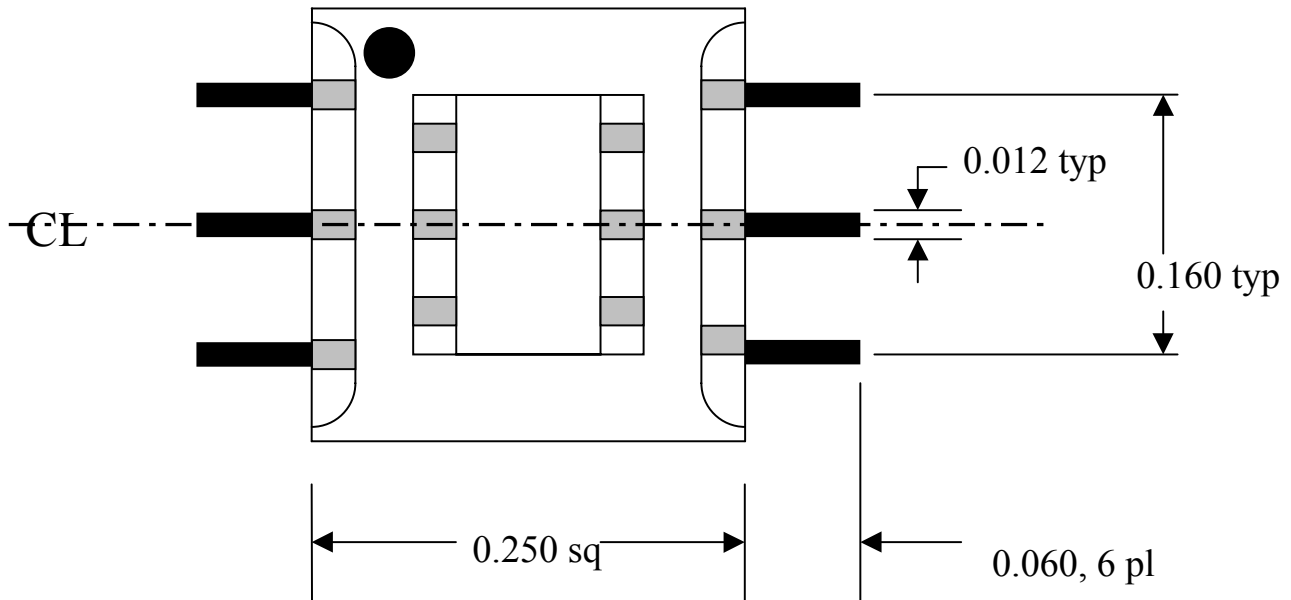

Top View

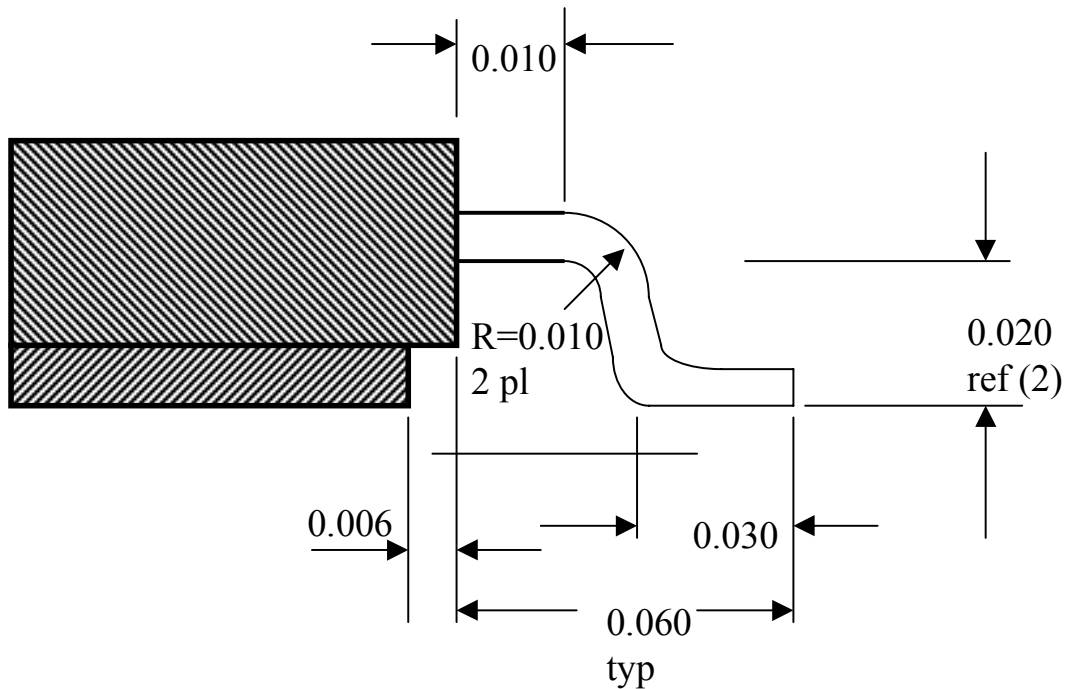

Side View

Note: Devices designated as EPU are typically early in their characterization process prior to finalizing all electrical and process specifications. Specifications are subject to change without notice.

Recommended PWB Land Pattern

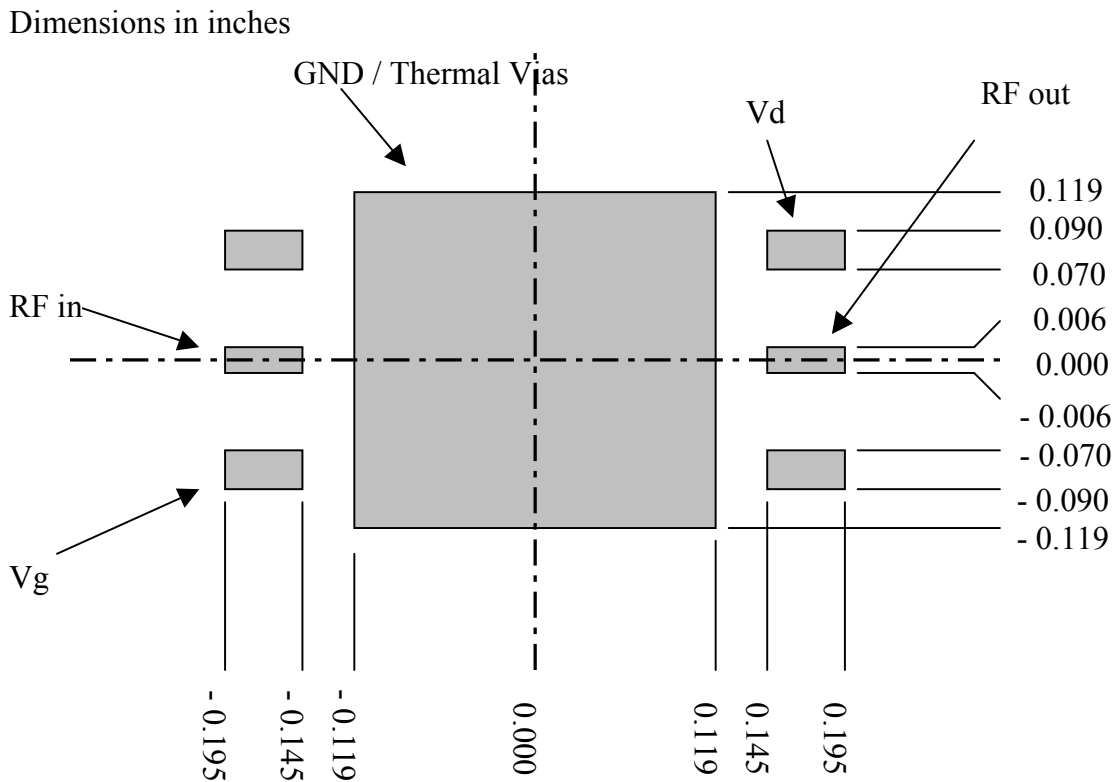

Note: Devices designated as EPU are typically early in their characterization process prior to finalizing all electrical and process specifications. Specifications are subject to change without notice.

Power Detector

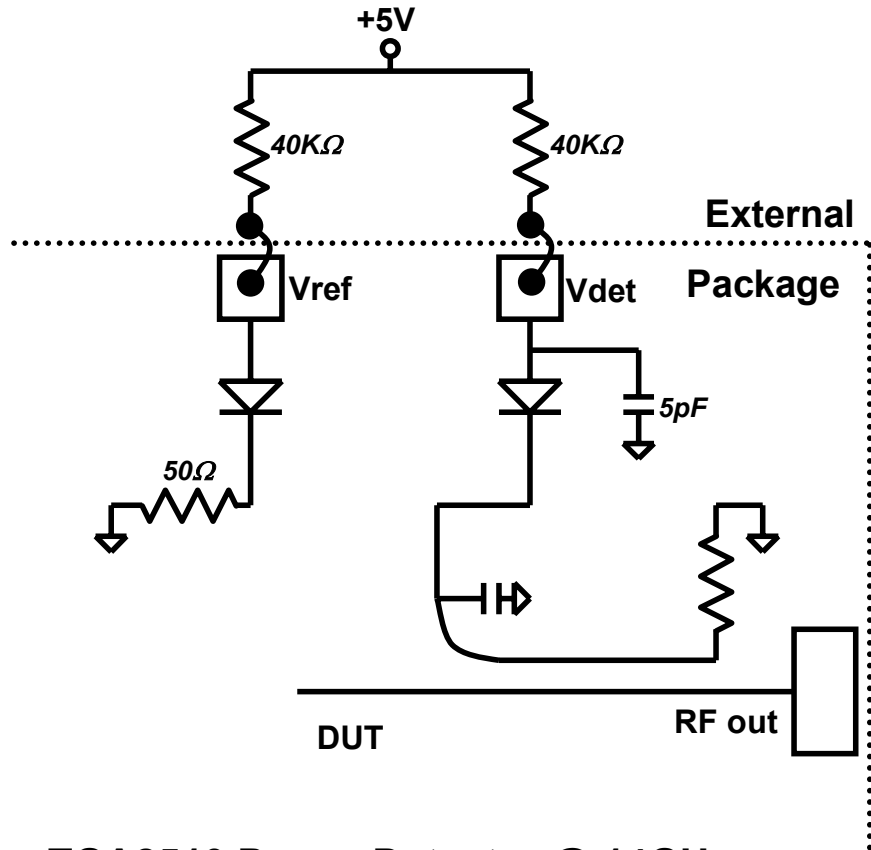

TGA2510 Power Detector @ 14GHz

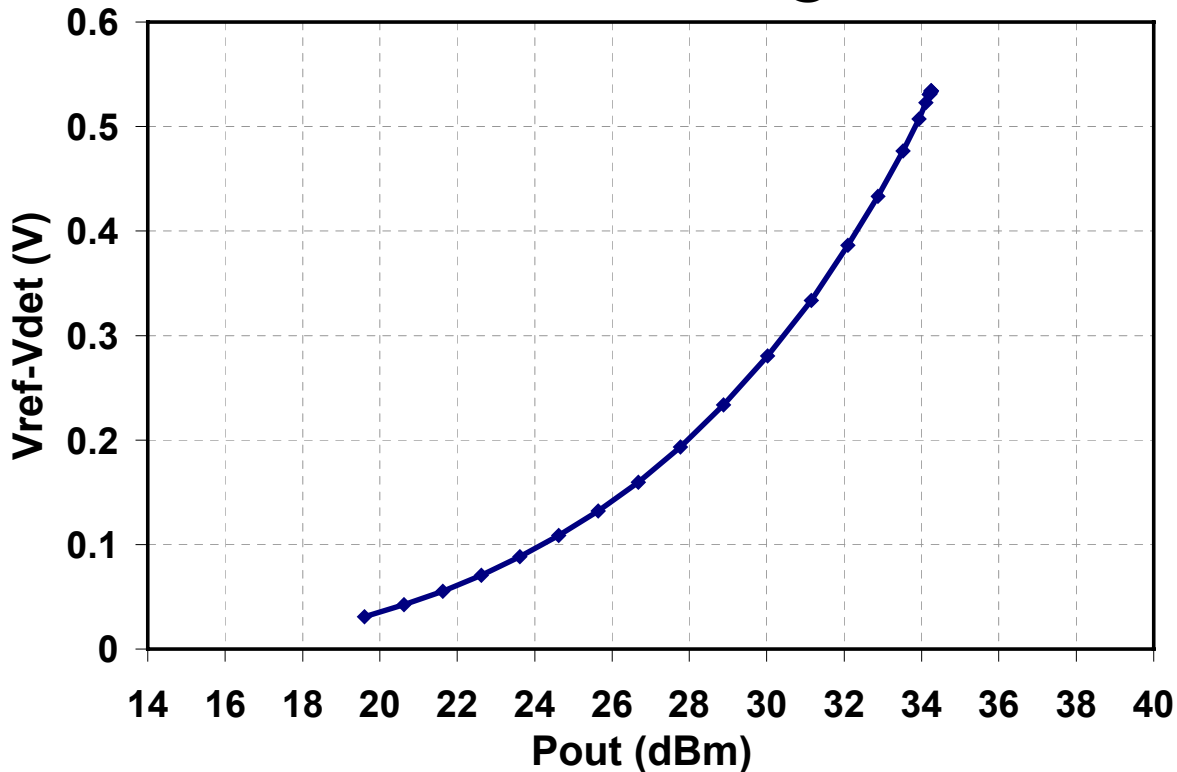

Note: Devices designated as EPU are typically early in their characterization process prior to finalizing all electrical and process specifications. Specifications are subject to change without notice.