

# DDP 2Gb E-die DDR3 SDRAM Specification

## 78 FBGA with Lead-Free & Halogen-Free (RoHS Compliant)

INFORMATION IN THIS DOCUMENT IS PROVIDED IN RELATION TO SAMSUNG PRODUCTS, AND IS SUBJECT TO CHANGE WITHOUT NOTICE. NOTHING IN THIS DOCUMENT SHALL BE CONSTRUED AS GRANTING ANY LICENSE, EXPRESS OR IMPLIED, BY ESTOPPEL OR OTHERWISE, TO ANY INTELLECTUAL PROPERTY RIGHTS IN SAMSUNG PRODUCTS OR TECHNOLOGY. ALL INFORMATION IN THIS DOCUMENT IS PROVIDED ON AS "AS IS" BASIS WITHOUT GUARANTEE OR WARRANTY OF ANY KIND.

1. For updates or additional information about Samsung products, contact your nearest Samsung office.
2. Samsung products are not intended for use in life support, critical care, medical, safety equipment, or similar applications where Product failure could result in loss of life or personal or physical harm, or any military or defense application, or any governmental procurement to which special terms or provisions may apply.

\* Samsung Electronics reserves the right to change products or specification without notice.

### Revision History

Revision	Month	Year	History
1.0	March	2009	- First release

**Table Contents**

**1.0 Ordering Information** ..... 5

**2.0 Key Features** ..... 5

**3.0 Package pinout/Mechanical Dimension & Addressing** ..... 6

    3.1 x4 DDP Package Pinout (Top view) : 78ball FBGA Package ..... 6

    3.2 x8 DDP Package Pinout (Top view) : 78ball FBGA Package ..... 7

    3.3 FBGA Package Dimension (x4) ..... 8

    3.4 FBGA Package Dimension (x8) ..... 9

**4.0 Input/Output Functional Description** ..... 10

**5.0 DDR3 SDRAM Addressing** ..... 11

**6.0 Absolute Maximum Ratings** ..... 12

    6.1 Absolute Maximum DC Ratings ..... 12

    6.2 DRAM Component Operating Temperature Range ..... 12

**7.0 AC & DC Operation Conditions** ..... 12

    7.1 Recommended DC operating Conditions (SSTL\_1.5) ..... 12

**8.0 AC & DC Input Measurement Levels** ..... 13

    8.1 AC and DC Logic input levels for single-ended signals ..... 13

    8.2 VREF Tolerances ..... 14

    8.3 AC and DC Logic Input Levels for Ditterential Signals ..... 15

        8.3.1 Differential signal definition ..... 15

        8.3.2 Differential swing requirement for clock (CK - CK) and strobe (DQS - DQS) ..... 15

        8.3.3 Single-ended requirements for differential signals ..... 16

    8.4 Differential Input Cross Point Voltage ..... 17

    8.5 Slew Rate Definition for Single Ended Input Signals ..... 17

    8.6 Slew rate definition for Differential Input Signals ..... 17

**9.0 AC and DC Output Measurement Levels** ..... 18

    9.1 Single Ended AC and DC Output Levels ..... 18

    9.2 Differential AC and DC Output Levels ..... 18

    9.3 Single Ended Output Slew Rate ..... 18

    9.4 Differential Output Slew Rate ..... 19

    9.5 Reference Load for AC Timing and Output Slew Rate ..... 19

    9.6 Overshoot/Undershoot Specification ..... 20

        9.6.1 Address and Control Overshoot and Undershoot specifications ..... 20

        9.6.2 Clock, Data, Strobe and Mask Overshoot and Undershoot specifications ..... 20

    9.7 34 ohm Output Driver DC Electrical Characteristics ..... 21

        9.7.1 Output Drive Temperature and Voltage sensitivity ..... 22

    9.8 On-Die Termination (ODT) Levels and I-V Characteristics ..... 22

        9.8.1 ODT DC electrical characteristics ..... 23

        9.8.2 ODT Temperature and Voltage sensitivity ..... 24

9.9 ODT Timing Definitions .....	25
9.9.1 Test Load for ODT Timings .....	25
9.9.2 ODT Timing Definition .....	25
10.0 IDD Specification Parameters and Test Conditions .....	28
10.1 IDD Measurement Conditions .....	28
10.2 IDD Specifications definition .....	30
11.0 DDP 2Gb DDR3 SDRAM E-die IDD Spec Table .....	37
12.0 Input/Output Capacitance .....	38
13.0 Electrical Characteristics and AC timing for DDR3-800 to DDR3-1600 .....	39
13.1 Clock specification .....	39
13.1.1 Definition for tCK (avg) .....	39
13.1.2 Definition for tCK (abs) .....	39
13.1.3 Definition for tCH(avg) and tCL(avg) .....	39
13.1.4 Definition for note for tJIT(per), tJIT(per,lck) .....	39
13.1.5 Definition for note for tJIT(cc), tJIT(cc,lck) .....	39
13.1.6 Definition for tERR(nper) .....	39
13.2 Refresh Parameters by Device Density .....	40
13.3 Speed Bins and CL, tRCD, tRP, tRC and tRAS for corresponding Bin .....	40
13.3.1 Speed Bin Table Notes .....	43
14.0 Timing Parameters by Speed Grade .....	44
14.1 Jitter Notes .....	47
14.2 Timing Parameter Notes .....	48
14.3 Address / Command Setup, Hold and Derating: .....	49
14.4 Data Setup, Hold and Slew Rate Derating: .....	55

**1.0 Ordering Information**

[ Table 1 ] Samsung DDP 2Gb DDR3 E-die ordering information table

Organization	DDR3-800 (6-6-6)	DDR3-1066 (7-7-7)	DDR3-1333 (9-9-9)	Package
512Mx4	K4B2G0446E-MCF7	K4B2G0446E-MCF8	K4B2G0446E-MCH9	78 FBGA
256Mx8	K4B2G0846E-MCF7	K4B2G0846E-MCF8	K4B2G0846E-MCH9	78 FBGA

Note :

1. Speed bin is in order of CL-tRCD-tRP.

**2.0 Key Features**

[ Table 2 ] DDP 2Gb DDR3 E-die Speed bins

Speed	DDR3-800	DDR3-1066	DDR3-1333	Unit
	6-6-6	7-7-7	9-9-9	
tCK(min)	2.5	1.875	1.5	ns
CAS Latency	6	7	9	nCK
tRCD(min)	15	13.125	13.5	ns
tRP(min)	15	13.125	13.5	ns
tRAS(min)	37.5	37.5	36	ns
tRC(min)	52.5	50.625	49.5	ns

- JEDEC standard 1.5V ± 0.075V Power Supply
- V<sub>DDQ</sub> = 1.5V ± 0.075V
- 400 MHz f<sub>CK</sub> for 800Mb/sec/pin, 533MHz f<sub>CK</sub> for 1066Mb/sec/pin, 667MHz f<sub>CK</sub> for 1333Mb/sec/pin
- 8 Banks
- Posted CAS
- Programmable CAS Latency(posted CAS): 6, 7, 8, 9, 10
- Programmable Additive Latency: 0, CL-2 or CL-1 clock
- Programmable CAS Write Latency (CWL) = 5 (DDR3-800), 6 (DDR3-1066) and 7 (DDR3-1333)
- 8-bit pre-fetch
- Burst Length: 8 (Interleave without any limit, sequential with starting address "000" only), 4 with tCCD = 4 which does not allow seamless read or write [either On the fly using A12 or MRS]
- Bi-directional Differential Data-Strobe
- Internal(self) calibration : Internal self calibration through ZQ pin (RZQ : 240 ohm ± 1%)
- On Die Termination using ODT pin
- Average Refresh Period 7.8us at lower than T<sub>CASE</sub> 85°C, 3.9us at 85°C < T<sub>CASE</sub> ≤ 95 °C
- Asynchronous Reset
- Package : 78 balls FBGA - x4/x8
- All of Lead-Free products are compliant for RoHS
- All of products are Halogen-free

The DDP 2Gb DDR3 SDRAM E-die is organized as a 64Mbit x 4 I/Os x 8banks, 32Mbit x 8 I/Os x 8banks. This synchronous device achieves high speed double-data-rate transfer rates of up to 1333Mb/sec/pin (DDR3-1333) for general applications.

The chip is designed to comply with the following key DDR3 SDRAM features such as posted CAS, Programmable CWL, Internal (Self) Calibration, On Die Termination using ODT pin and Asynchronous Reset .

All of the control and address inputs are synchronized with a pair of externally supplied differential clocks. Inputs are latched at the crosspoint of differential clocks (CK rising and CK falling). All I/Os are synchronized with a pair of bidirectional strobes (DQS and DQS) in a source synchronous fashion. The address bus is used to convey row, column, and bank address information in a RAS/CAS multiplexing style. The DDR3 device operates with a single 1.5V ± 0.075V power supply and 1.5V ± 0.075V V<sub>DDQ</sub>.

The 2Gb DDR3 E-die device is available in 78ball FBGAs(x4/x8).

Note : 1. The functionality described and the timing specifications included in this data sheet are for the DLL Enabled mode of operation.

Note : This data sheet is an abstract of full DDR3 specification and does not cover the common features which are described in "DDR3 SDRAM Device Operation & Timing Diagram".

3.0 Package pinout/Mechanical Dimension & Addressing

3.1 x4 DDP Package Pinout (Top view) : 78ball FBGA Package

	1	2	3	4	5	6	7	8	9	
A	V <sub>SS</sub>	V <sub>DD</sub>	NC				NC	V <sub>SS</sub>	V <sub>DD</sub>	A
B	V <sub>SS</sub>	V <sub>SSQ</sub>	DQ0				DM	V <sub>SSQ</sub>	V <sub>DDQ</sub>	B
C	V <sub>DDQ</sub>	DQ2	DQS				DQ1	DQ3	V <sub>SSQ</sub>	C
D	V <sub>SSQ</sub>	NC	DQS				V <sub>DD</sub>	V <sub>SS</sub>	V <sub>SSQ</sub>	D
E	V <sub>REFDQ</sub>	V <sub>DDQ</sub>	NC				NC	NC	V <sub>DDQ</sub>	E
F	ODT1	V <sub>SS</sub>	RAS				CK	V <sub>SS</sub>	CKE1	F
G	ODT0	V <sub>DD</sub>	CAS				CK	V <sub>DD</sub>	CKE0	G
H	CS1	CS0	WE				A10/AP	ZQ0	ZQ1	H
J	V <sub>SS</sub>	BA0	BA2				NC	V <sub>REFCA</sub>	V <sub>SS</sub>	J
K	V <sub>DD</sub>	A3	A0				A12/BC	BA1	V <sub>DD</sub>	K
L	V <sub>SS</sub>	A5	A2				A1	A4	V <sub>SS</sub>	L
M	V <sub>DD</sub>	A7	A9				A11	A6	V <sub>DD</sub>	M
N	V <sub>SS</sub>	RESET	A13				NC	A8	V <sub>SS</sub>	N

Ball Locations (x4)

- Populated ball
- + Ball not populated

Top view  
(See the balls through the package)

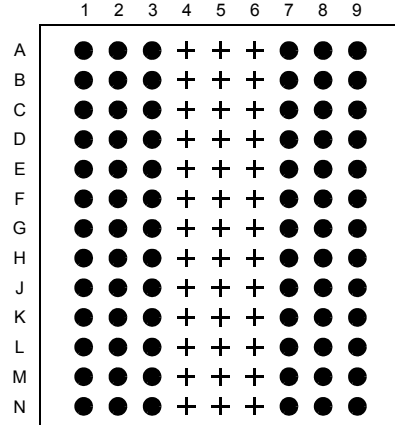

3.2 x8 DDP Package Pinout (Top view) : 78ball FBGA Package

	1	2	3	4	5	6	7	8	9	
A	V <sub>SS</sub>	V <sub>DD</sub>	NC				$\overline{\text{NU/TDQS}}$	V <sub>SS</sub>	V <sub>DD</sub>	A
B	V <sub>SS</sub>	V <sub>SSQ</sub>	DQ0				$\overline{\text{DM/TDQS}}$	V <sub>SSQ</sub>	V <sub>DDQ</sub>	B
C	V <sub>DDQ</sub>	DQ2	DQS				DQ1	DQ3	V <sub>SSQ</sub>	C
D	V <sub>SSQ</sub>	DQ6	$\overline{\text{DQS}}$				V <sub>DD</sub>	V <sub>SS</sub>	V <sub>SSQ</sub>	D
E	V <sub>REFDQ</sub>	V <sub>DDQ</sub>	DQ4				DQ7	DQ5	V <sub>DDQ</sub>	E
F	ODT1	V <sub>SS</sub>	$\overline{\text{RAS}}$				CK	V <sub>SS</sub>	CKE1	F
G	ODT0	V <sub>DD</sub>	$\overline{\text{CAS}}$				$\overline{\text{CK}}$	V <sub>DD</sub>	CKE0	G
H	$\overline{\text{CS1}}$	$\overline{\text{CS0}}$	$\overline{\text{WE}}$				A10/AP	ZQ0	ZQ1	H
J	V <sub>SS</sub>	BA0	BA2				NC	V <sub>REFCA</sub>	V <sub>SS</sub>	J
K	V <sub>DD</sub>	A3	A0				A12/ $\overline{\text{BC}}$	BA1	V <sub>DD</sub>	K
L	V <sub>SS</sub>	A5	A2				A1	A4	V <sub>SS</sub>	L
M	V <sub>DD</sub>	A7	A9				A11	A6	V <sub>DD</sub>	M
N	V <sub>SS</sub>	$\overline{\text{RESET}}$	A13				NC	A8	V <sub>SS</sub>	N

Ball Locations (x8)

- Populated ball
- + Ball not populated

Top view  
(See the balls through the package)

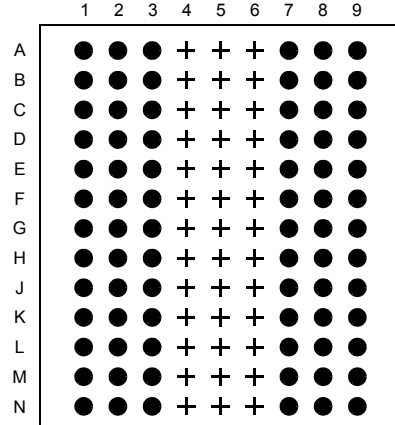

3.3 FBGA Package Dimension (x4)

Units : Millimeters

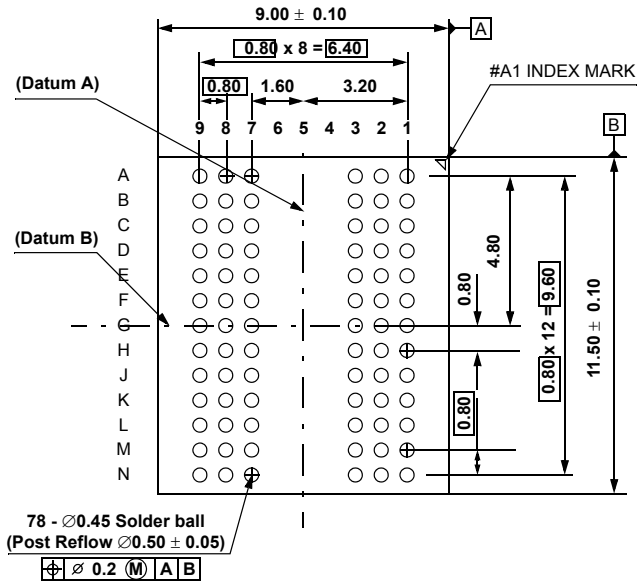

BOTTOM VIEW

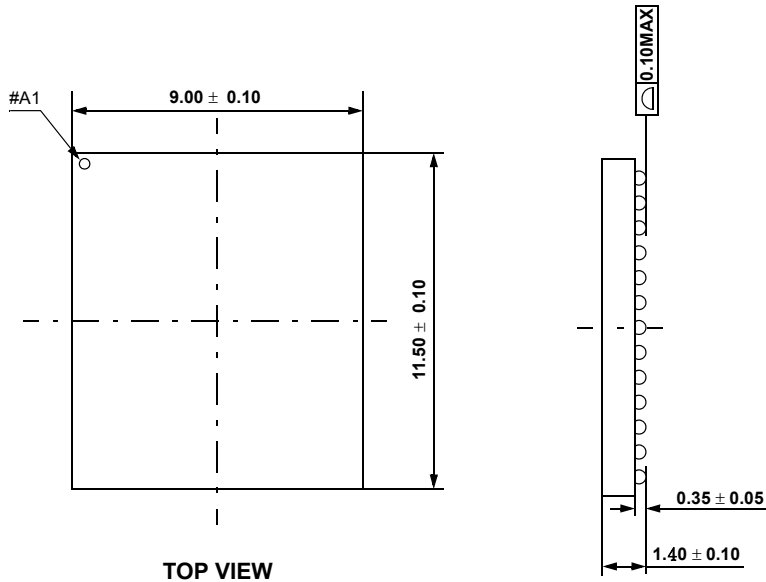

TOP VIEW



3.4 FBGA Package Dimension (x8)

Units : Millimeters

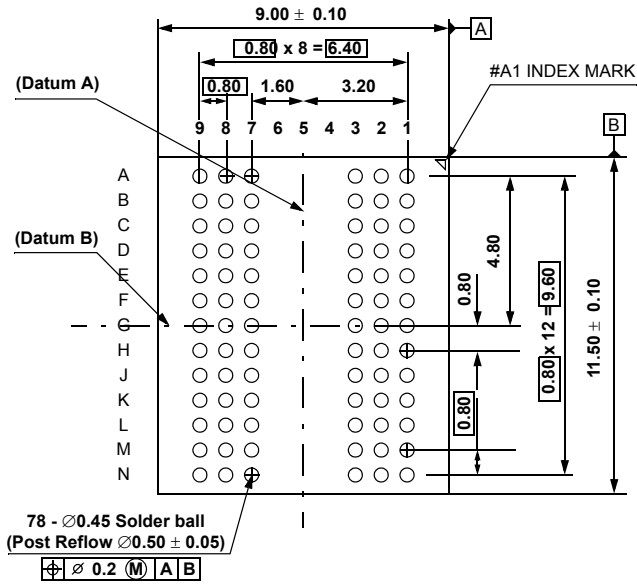

BOTTOM VIEW

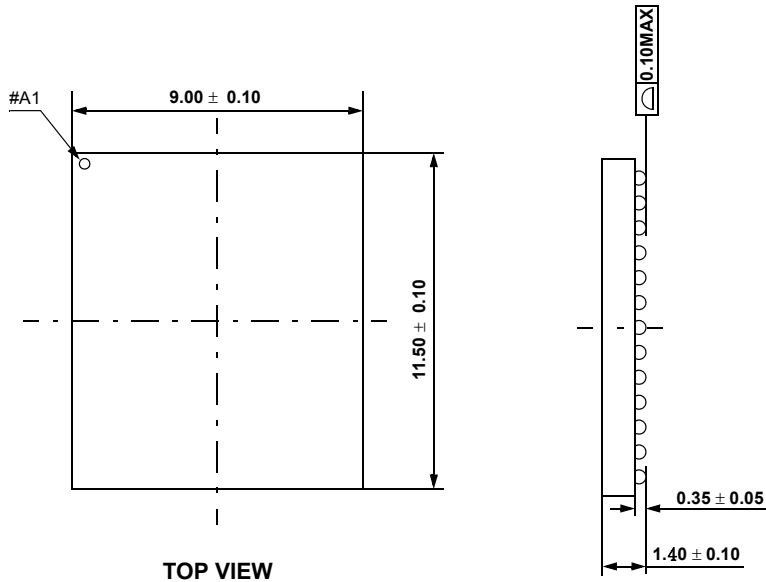

TOP VIEW

## 4.0 Input/Output Functional Description

[ Table 3 ] Input/Output function description

Symbol	Type	Function
CK, $\overline{\text{CK}}$	Input	<b>Clock:</b> CK and $\overline{\text{CK}}$ are differential clock inputs. All address and control input signals are sampled on the crossing of the positive edge of CK and negative edge of $\overline{\text{CK}}$ . Output (read) data is referenced to the crossings of CK and $\overline{\text{CK}}$
CKE	Input	<b>Clock Enable:</b> CKE HIGH activates, and CKE Low deactivates, internal clock signals and device input buffers and output drivers. Taking CKE Low provides Precharge Power-Down and Self Refresh operation (all banks idle), or Active Power-Down (Row Active in any bank). CKE is asynchronous for self refresh exit. After $V_{\text{REFCA}}$ has become stable during the power on and initialization sequence, it must be maintained during all operations (including Self-Refresh). CKE must be maintained high throughout read and write accesses. Input buffers, excluding CK, $\overline{\text{CK}}$ , ODT and CKE are disabled during power-down. Input buffers, excluding CKE, are disabled during Self -Refresh.
$\overline{\text{CS}}$	Input	<b>Chip Select:</b> All commands are masked when $\overline{\text{CS}}$ is registered HIGH. $\overline{\text{CS}}$ provides for external Rank selection on systems with multiple Ranks. $\overline{\text{CS}}$ is considered part of the command code.
ODT	Input	<b>On Die Termination:</b> ODT (registered HIGH) enables termination resistance internal to the DDR3 SDRAM. When enabled, ODT is only applied to each DQ, DQS, $\overline{\text{DQS}}$ and DM/TDQS, NU/ $\overline{\text{TDQS}}$ (When TDQS is enabled via Mode Register A11=1 in MR1) signal for x8 configurations. The ODT pin will be ignored if the Mode Register (MR1) is programmed to disable ODT.
$\overline{\text{RAS}}$ , $\overline{\text{CAS}}$ , $\overline{\text{WE}}$	Input	<b>Command Inputs:</b> $\overline{\text{RAS}}$ , $\overline{\text{CAS}}$ and $\overline{\text{WE}}$ (along with $\overline{\text{CS}}$ ) define the command being entered.
DM (DMU), (DML)	Input	<b>Input Data Mask:</b> DM is an input mask signal for write data. Input data is masked when DM is sampled HIGH coincident with that input data during a Write access. DM is sampled on both edges of DQS. For x8 device, the function of DM or TDQS/ $\overline{\text{TDQS}}$ is enabled by Mode Register A11 setting in MR1.
BA0 - BA2	Input	<b>Bank Address Inputs:</b> BA0 - BA2 define to which bank an Active, Read, Write or Precharge command is being applied. Bank address also determines if the mode register or extended mode register is to be accessed during a MRS cycle.
A0 - A13	Input	<b>Address Inputs:</b> Provided the row address for Active commands and the column address for Read/Write commands to select one location out of the memory array in the respective bank. (A10/AP and A12/ $\overline{\text{BC}}$ have additional functions, see below) The address inputs also provide the op-code during Mode Register Set commands.
A10 / AP	Input	<b>Autoprecharge:</b> A10 is sampled during Read/Write commands to determine whether Autoprecharge should be performed to the accessed bank after the Read/Write operation. (HIGH:Autoprecharge; LOW: No Autoprecharge) A10 is sampled during a Precharge command to determine whether the Precharge applies to one bank (A10 LOW) or all banks (A10 HIGH). if only one bank is to be precharged, the bank is selected by bank addresses.
A12 / $\overline{\text{BC}}$	Input	<b>Burst Chop:</b> A12 is sampled during Read and Write commands to determine if burst chop(on-the-fly) will be performed. (HIGH : no burst chop, LOW : burst chopped). See command truth table for details
$\overline{\text{RESET}}$	Input	<b>Active Low Asynchronous Reset:</b> Reset is active when $\overline{\text{RESET}}$ is LOW, and inactive when $\overline{\text{RESET}}$ is HIGH. $\overline{\text{RESET}}$ must be HIGH during normal operation. $\overline{\text{RESET}}$ is a CMOS rail to rail signal with DC high and low at 80% and 20% of $V_{\text{DD}}$ , i.e. 1.20V for DC high and 0.30V for DC low.
DQ	Input/Output	<b>Data Input/ Output:</b> Bi-directional data bus.
DQS, ( $\overline{\text{DQS}}$ )	Input/Output	<b>Data Strobe:</b> Output with read data, input with write data. Edge-aligned with read data, centered in write data. For the x16, DQSL: corresponds to the data on DQL0-DQL7; DQSU corresponds to the data on DQU0-DQU7. The data strobe DQS, DQSL and DQSU are paired with differential signals $\overline{\text{DQS}}$ , $\overline{\text{DQSL}}$ and $\overline{\text{DQSU}}$ , respectively, to provide differential pair signaling to the system during reads and writes. DDR3 SDRAM supports differential data strobe only and does not support single-ended.
TDQS, ( $\overline{\text{TDQS}}$ )	Output	<b>Termination Data Strobe:</b> TDQS/ $\overline{\text{TDQS}}$ is applicable for X8 DRAMs only. When enabled via Mode Register A11=1 in MR1, DRAM will enable the same termination resistance function on TDQS/ $\overline{\text{TDQS}}$ that is applied to DQS/DQS. When disabled via mode register A11=0 in MR1, DM/TDQS will provide the data mask function and $\overline{\text{TDQS}}$ is not used. x4/ x16 DRAMs must disable the TDQS function via mode register A11=0 in MR1.
NC		<b>No Connect:</b> No internal electrical connection is present.
$V_{\text{DDQ}}$	Supply	<b>DQ Power Supply:</b> 1.5V +/- 0.075V
$V_{\text{SSQ}}$	Supply	<b>DQ Ground</b>
$V_{\text{DD}}$	Supply	<b>Power Supply:</b> 1.5V +/- 0.075V
$V_{\text{SS}}$	Supply	<b>Ground</b>
$V_{\text{REFDQ}}$	Supply	<b>Reference voltage for DQ</b>
$V_{\text{REFCA}}$	Supply	<b>Reference voltage for CA</b>
ZQ	Supply	<b>Reference Pin for ZQ calibration</b>

Note : Input only pins (BA0-BA2, A0-A12,  $\overline{\text{RAS}}$ ,  $\overline{\text{CAS}}$ ,  $\overline{\text{WE}}$ ,  $\overline{\text{CS}}$ , CKE, ODT and  $\overline{\text{RESET}}$ ) do not supply termination.

## 5.0 DDR3 SDRAM Addressing

### 1Gb

Configuration	256Mb x 4	128Mb x 8	64Mb x 16
# of Bank	8	8	8
Bank Address	BA0 - BA2	BA0 - BA2	BA0 - BA2
Auto precharge	A <sub>10</sub> /AP	A <sub>10</sub> /AP	A <sub>10</sub> /AP
Row Address	A <sub>0</sub> - A <sub>13</sub>	A <sub>0</sub> - A <sub>13</sub>	A <sub>0</sub> - A <sub>12</sub>
Column Address	A <sub>0</sub> - A <sub>9</sub> ,A <sub>11</sub>	A <sub>0</sub> - A <sub>9</sub>	A <sub>0</sub> - A <sub>9</sub>
BC switch on the fly	A <sub>12</sub> / $\overline{BC}$	A <sub>12</sub> / $\overline{BC}$	A <sub>12</sub> / $\overline{BC}$
Page size *1	1 KB	1 KB	2 KB

### 2Gb

Configuration	512Mb x 4	256Mb x 8	128Mb x 16
# of Bank	8	8	8
Bank Address	BA0 - BA2	BA0 - BA2	BA0 - BA2
Auto precharge	A <sub>10</sub> /AP	A <sub>10</sub> /AP	A <sub>10</sub> /AP
Row Address	A <sub>0</sub> - A <sub>14</sub>	A <sub>0</sub> - A <sub>14</sub>	A <sub>0</sub> - A <sub>13</sub>
Column Address	A <sub>0</sub> - A <sub>9</sub> ,A <sub>11</sub>	A <sub>0</sub> - A <sub>9</sub>	A <sub>0</sub> - A <sub>9</sub>
BC switch on the fly	A <sub>12</sub> / $\overline{BC}$	A <sub>12</sub> / $\overline{BC}$	A <sub>12</sub> / $\overline{BC}$
Page size *1	1 KB	1 KB	2 KB

### 4Gb

Configuration	1Gb x 4	512Mb x 8	256Mb x 16
# of Bank	8	8	8
Bank Address	BA0 - BA2	BA0 - BA2	BA0 - BA2
Auto precharge	A <sub>10</sub> /AP	A <sub>10</sub> /AP	A <sub>10</sub> /AP
Row Address	A <sub>0</sub> - A <sub>15</sub>	A <sub>0</sub> - A <sub>15</sub>	A <sub>0</sub> - A <sub>14</sub>
Column Address	A <sub>0</sub> - A <sub>9</sub> ,A <sub>11</sub>	A <sub>0</sub> - A <sub>9</sub>	A <sub>0</sub> - A <sub>9</sub>
BC switch on the fly	A <sub>12</sub> / $\overline{BC}$	A <sub>12</sub> / $\overline{BC}$	A <sub>12</sub> / $\overline{BC}$
Page size *1	1 KB	1 KB	2 KB

### 8Gb

Configuration	2Gb x 4	1Gb x 8	512Mb x 16
# of Bank	8	8	8
Bank Address	BA0 - BA2	BA0 - BA2	BA0 - BA2
Auto precharge	A <sub>10</sub> /AP	A <sub>10</sub> /AP	A <sub>10</sub> /AP
Row Address	A <sub>0</sub> - A <sub>15</sub>	A <sub>0</sub> - A <sub>15</sub>	A <sub>0</sub> - A <sub>15</sub>
Column Address	A <sub>0</sub> - A <sub>9</sub> ,A <sub>11</sub> ,A <sub>13</sub>	A <sub>0</sub> - A <sub>9</sub> ,A <sub>11</sub>	A <sub>0</sub> - A <sub>9</sub>
BC switch on the fly	A <sub>12</sub> / $\overline{BC}$	A <sub>12</sub> / $\overline{BC}$	A <sub>12</sub> / $\overline{BC}$
Page size *1	2 KB	2 KB	2 KB

Note 1 : Page size is the number of bytes of data delivered from the array to the internal sense amplifiers when an ACTIVE command is registered.

Page size is per bank, calculated as follows:  $\text{page size} = 2^{\text{COLBITS}} * \text{ORG} \div 8$

where, COLBITS = the number of column address bits, ORG = the number of I/O (DQ) bits

## 6.0 Absolute Maximum Ratings

### 6.1 Absolute Maximum DC Ratings

[ Table 4 ] Absolute Maximum DC Ratings

Symbol	Parameter	Rating	Units	Notes
V <sub>DD</sub>	Voltage on V <sub>DD</sub> pin relative to V <sub>SS</sub>	-0.4 V ~ 1.975 V	V	1,3
V <sub>DDQ</sub>	Voltage on V <sub>DDQ</sub> pin relative to V <sub>SS</sub>	-0.4 V ~ 1.975 V	V	1,3
V <sub>IN</sub> , V <sub>OUT</sub>	Voltage on any pin relative to V <sub>SS</sub>	-0.4 V ~ 1.975 V	V	1
T <sub>STG</sub>	Storage Temperature	-55 to +100	°C	1, 2

Note :

- Stresses greater than those listed under “Absolute Maximum Ratings” may cause permanent damage to the device. This is a stress rating only and functional operation of the device at these or any other conditions above those indicated in the operational sections of this specification is not implied. Exposure to absolute maximum rating conditions for extended periods may affect reliability.
- Storage Temperature is the case surface temperature on the center/top side of the DRAM. For the measurement conditions, please refer to JEDEC standard.
- V<sub>DD</sub> and V<sub>DDQ</sub> must be within 300mV of each other at all times; and V<sub>REF</sub> must be not greater than 0.6 x V<sub>DDQ</sub>. When V<sub>DD</sub> and V<sub>DDQ</sub> are less than 500mV; V<sub>REF</sub> may be equal to or less than 300mV.

### 6.2 DRAM Component Operating Temperature Range

[ Table 5 ] Temperature Range

Symbol	Parameter	rating	Unit	Notes
T <sub>OPER</sub>	Operating Temperature Range	0 to 95	°C	1, 2, 3

Note :

- Operating Temperature T<sub>OPER</sub> is the case surface temperature on the center/top side of the DRAM. For measurement conditions, please refer to the JEDEC document JESD51-2.
- The Normal Temperature Range specifies the temperatures where all DRAM specifications will be supported. During operation, the DRAM case temperature must be maintained between 0-85°C under all operating conditions
- Some applications require operation of the Extended Temperature Range between 85°C and 95°C case temperature. Full specifications are guaranteed in this range, but the following additional conditions apply:
  - Refresh commands must be doubled in frequency, therefore reducing the refresh interval tREFI to 3.9us. It is also possible to specify a component with 1X refresh (tREFI to 7.8us) in the Extended Temperature Range.
  - If Self-Refresh operation is required in the Extended Temperature Range, then it is mandatory to either use the Manual Self-Refresh mode with Extended Temperature Range capability (MR2 A6 = 0b and MR2 A7 = 1b) or enable the optional Auto Self-Refresh mode (MR2 A6 = 1b and MR2 A7 = 0b)

## 7.0 AC & DC Operation Conditions

### 7.1 Recommended DC operating Conditions (SSTL\_1.5)

[ Table 6 ] Recommended DC Operating Conditions

Symbol	Parameter	Rating			Units	Notes
		Min.	Typ.	Max.		
V <sub>DD</sub>	Supply Voltage	1.425	1.5	1.575	V	1,2
V <sub>DDQ</sub>	Supply Voltage for Output	1.425	1.5	1.575	V	1,2

Note :

- Under all conditions V<sub>DDQ</sub> must be less than or equal to V<sub>DD</sub>.
- V<sub>DDQ</sub> tracks with V<sub>DD</sub>. AC parameters are measured with V<sub>DD</sub> and V<sub>DDQ</sub> tied together.

## 8.0 AC & DC Input Measurement Levels

### 8.1 AC and DC Logic input levels for single-ended signals

[ Table 7 ] Single Ended AC and DC input levels for Command and Address

Symbol	Parameter	DDR3-800/1066		DDR3-1333/1600		Unit	Notes
		Min.	Max.	Min.	Max.		
V <sub>IH,CA</sub> (DC)	DC input logic high	V <sub>REF</sub> + 100	V <sub>DD</sub>	V <sub>REF</sub> + 100	V <sub>DD</sub>	mV	1
V <sub>IL,CA</sub> (DC)	DC input logic low	V <sub>SS</sub>	V <sub>REF</sub> - 100	V <sub>SS</sub>	V <sub>REF</sub> - 100	mV	1
V <sub>IH,CA</sub> (AC)	AC input logic high	V <sub>REF</sub> + 175	-	V <sub>REF</sub> + 175	-	mV	1,2
V <sub>IL,CA</sub> (AC)	AC input logic low	-	V <sub>REF</sub> - 175	-	V <sub>REF</sub> - 175	mV	1,2
V <sub>IH,CA</sub> (AC150)	AC input logic high	-	-	V <sub>REF</sub> +150	-	mV	1,2
V <sub>IL,CA</sub> (AC150)	AC input logic lowM	-	-	-	V <sub>REF</sub> -150	mV	1,2
V <sub>REFCA</sub> (DC)	Reference Voltage for ADD, CMD inuts	0.49*V <sub>DD</sub>	0.51*V <sub>DD</sub>	0.49*V <sub>DD</sub>	0.51*V <sub>DD</sub>	V	3,4

Note :

1. For input only pins except  $\overline{\text{RESET}}$ , V<sub>REF</sub> = V<sub>REFCA</sub>(DC)
2. See 9.6 "Overshoot and Undershoot specifications"
3. The AC peak noise on V<sub>REF</sub> may not allow V<sub>REF</sub> to deviate from V<sub>REF</sub>(DC) by more than ± 1% V<sub>DD</sub> (for reference : approx. ± 15mV)
4. For reference : approx. V<sub>DD</sub>/2 ± 15mV

[ Table 8 ] Single Ended AC and DC input levels for DQ and DM

Symbol	Parameter	DDR3-800/1066		DDR3-1333		Unit	Notes
		Min.	Max.	Min.	Max.		
V <sub>IH,DQ</sub> (DC100)	DC input logic high	V <sub>REF</sub> + 100	V <sub>DD</sub>	V <sub>REF</sub> + 100	V <sub>DD</sub>	mV	1
V <sub>IL,DQ</sub> (DC100)	DC input logic low	V <sub>SS</sub>	V <sub>REF</sub> - 100	V <sub>SS</sub>	V <sub>REF</sub> - 100	mV	1
V <sub>IH,DQ</sub> (AC175)	AC input logic high	V <sub>REF</sub> + 175	-	V <sub>REF</sub> + 150	-	mV	1,2,5
V <sub>IL,DQ</sub> (AC175)	AC input logic low	-	V <sub>REF</sub> - 175	-	V <sub>REF</sub> - 150	mV	1,2,5
V <sub>IH,DQ</sub> (AC150)	AC input logic high	V <sub>REF</sub> + 150	Note 2	-	-	mV	1,2,5
V <sub>IL,DQ</sub> (AC150)	AC input logic low	Note 2	V <sub>REF</sub> - 150	-	-	mV	1,2,5
V <sub>REFDQ</sub> (DC)	I/O Reference Voltage(DQ)	0.49*V <sub>DD</sub>	0.51*V <sub>DD</sub>	0.49*V <sub>DD</sub>	0.51*V <sub>DD</sub>	V	3,4

Note :

1. For input only pins except  $\overline{\text{RESET}}$ , V<sub>REF</sub> = V<sub>REFDQ</sub>(DC)
2. See "Overshoot and Undershoot specifications"
3. The AC peak noise on V<sub>REF</sub> may not allow V<sub>REF</sub> to deviate from V<sub>REF</sub>(DC) by more than ± 1% V<sub>DD</sub> (for reference : approx. ± 15mV)
4. For reference : approx. V<sub>DD</sub>/2 ± 15mV
5. Single ended swing requirement for DQS -  $\overline{\text{DQS}}$  is 350mV (peak to peak). Differential swing for DQS -  $\overline{\text{DQS}}$  is 700mV (peak to peak).

## 8.2 $V_{REF}$ Tolerances

The dc-tolerance limits and ac-noise limits for the reference voltages  $V_{REFCA}$  and  $V_{REFDQ}$  are illustrate in Figure 1. It shows a valid reference voltage  $V_{REF}(t)$  as a function of time. ( $V_{REF}$  stands for  $V_{REFCA}$  and  $V_{REFDQ}$  likewise).

$V_{REF}(DC)$  is the linear average of  $V_{REF}(t)$  over a very long period of time (e.g. 1 sec). This average has to meet the min/max requirements in table 7. Furthermore  $V_{REF}(t)$  may temporarily deviate from  $V_{REF}(DC)$  by no more than  $\pm 1\% V_{DD}$ .

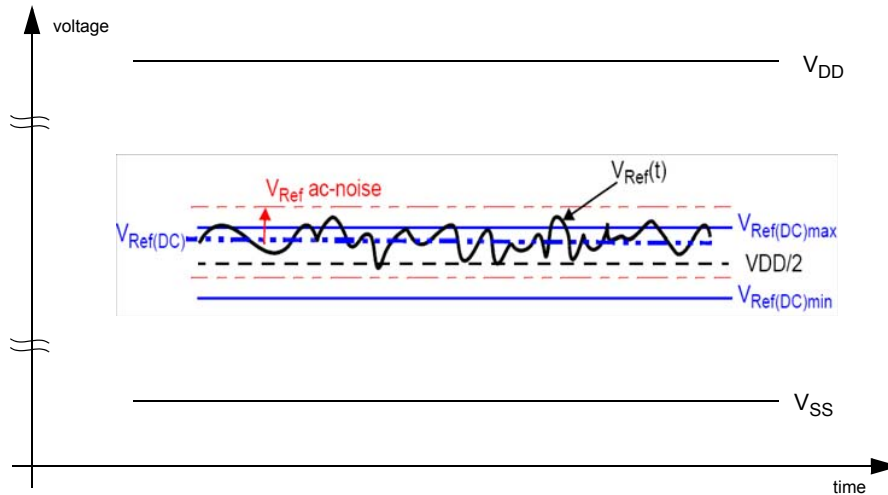

Figure 1. Illustration of  $V_{REF}(DC)$  tolerance and  $V_{REF}$  ac-noise limits

The voltage levels for setup and hold time measurements  $V_{IH}(AC)$ ,  $V_{IH}(DC)$ ,  $V_{IL}(AC)$  and  $V_{IL}(DC)$  are dependent on  $V_{REF}$ .

" $V_{REF}$ " shall be understood as  $V_{REF}(DC)$ , as defined in Figure 1.

This clarifies, that dc-variations of  $V_{REF}$  affect the absolute voltage a signal has to reach to achieve a valid high or low level and therefore the time to which setup and hold is measured. System timing and voltage budgets need to account for  $V_{REF}(DC)$  deviations from the optimum position within the data-eye of the input signals.

This also clarifies that the DRAM setup/hold specification and derating values need to include time and voltage associated with  $V_{REF}$  ac-noise. Timing and voltage effects due to ac-noise on  $V_{REF}$  up to the specified limit ( $\pm 1\%$  of  $V_{DD}$ ) are included in DRAM timings and their associated deratings.

8.3 AC and DC Logic Input Levels for Ditterential Signals

8.3.1 Differential signal definition

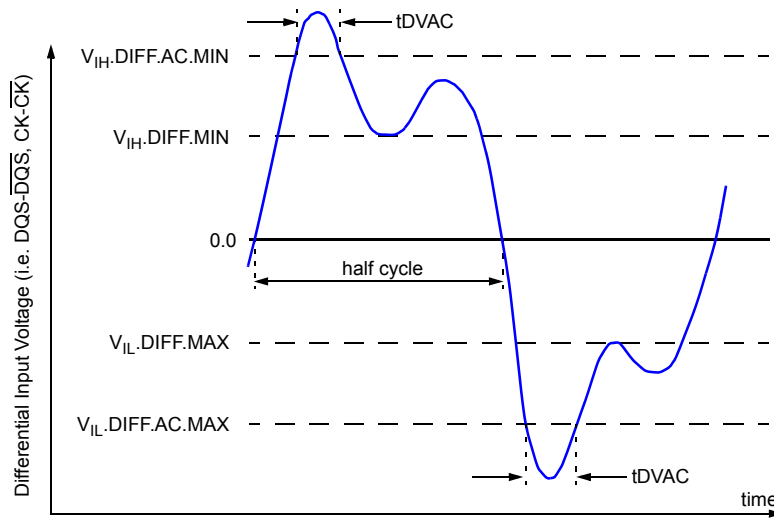

Figure 2 : Definition of differential ac-swing and "time above ac level" tDVAC

8.3.2 Differential swing requirement for clock (CK - CK) and strobe (DQS - DQS)

[ Table 9 ] Defferential AC and DC Input Levels

Symbol	Parameter	DDR3-800/1066/1333/1600		unit	Note
		min	max		
$V_{IHdiff}$	differential input high	+0.2	note 3	V	1
$V_{ILdiff}$	differential input low	note 3	-0.2	V	1
$V_{IHdiff}(AC)$	differential input high ac	$2 \times (V_{IH}(AC) - V_{REF})$	note 3	V	2
$V_{ILdiff}(AC)$	differential input low ac	note 3	$2 \times (V_{REF} - V_{IL}(AC))$	V	2

Notes:

- Used to define a differential signal slew-rate.
- for CK - CK use  $V_{IH}/V_{IL}(AC)$  of ADD/CMD and  $V_{REFCA}$ ; for DQS - DQS, DQSL - DQSL, DQSU - DQSU use  $V_{IH}/V_{IL}(AC)$  of DQs and  $V_{REFDQ}$ ; if a reduced ac-high or ac-low level is used for a signal group, then the reduced level applies also here.
- These values are not defined, however they single-ended signals CK, CK, DQS, DQS, DQSL, DQSL, DQSU, DQSU need to be within the respective limits ( $V_{IH}(DC)$  max,  $V_{IL}(DC)$ min) for single-ended signals as well as the limitations for overshoot and undershoot. Reter to "overshoot and Undersheet Specification "

[ Table 10 ] Allowed time before ringback (tDVAC) for CLK - CLK and DQS - DQS

Slew Rate [V/ns]	tDVAC [ps] @ $ V_{IH/Ldiff}(AC)  = 350mV$		tDVAC [ps] @ $ V_{IH/Ldiff}(AC)  = 300mV$	
	min	max	min	max
> 4.0	75	-	175	-
4.0	57	-	170	-
3.0	50	-	167	-
2.0	38	-	163	-
1.8	34	-	162	-
1.6	29	-	161	-
1.4	22	-	159	-
1.2	13	-	155	-
1.0	0	-	150	-
< 1.0	0	-	150	-

8.3.3 Single-ended requirements for differential signals

Each individual component of a differential signal (CK, DQS, DQSL, DQSU,  $\overline{\text{CK}}$ ,  $\overline{\text{DQS}}$ ,  $\overline{\text{DQSL}}$ , or  $\overline{\text{DQSU}}$ ) has also to comply with certain requirements for single-ended signals.

CK and  $\overline{\text{CK}}$  have to approximately reach  $V_{\text{SEHmin}} / V_{\text{SELmax}}$  (approximately equal to the ac-levels ( $V_{\text{IH(AC)}} / V_{\text{IL(AC)}})$ ) for ADD/CMD signals) in every half-cycle.

DQS, DQSL, DQSU,  $\overline{\text{DQS}}$ ,  $\overline{\text{DQSL}}$  have to reach  $V_{\text{SEHmin}} / V_{\text{SELmax}}$  (approximately the ac-levels ( $V_{\text{IH(AC)}} / V_{\text{IL(AC)}})$ ) for DQ signals) in every half-cycle preceding and following a valid transition.

Note that the applicable ac-levels for ADD/CMD and DQ's might be different per speed-bin etc. E.g. if  $V_{\text{IH150(AC)}}/V_{\text{IL150(AC)}}$  is used for ADD/CMD signals, then these ac-levels apply also for the single-ended signals CK and  $\overline{\text{CK}}$ .

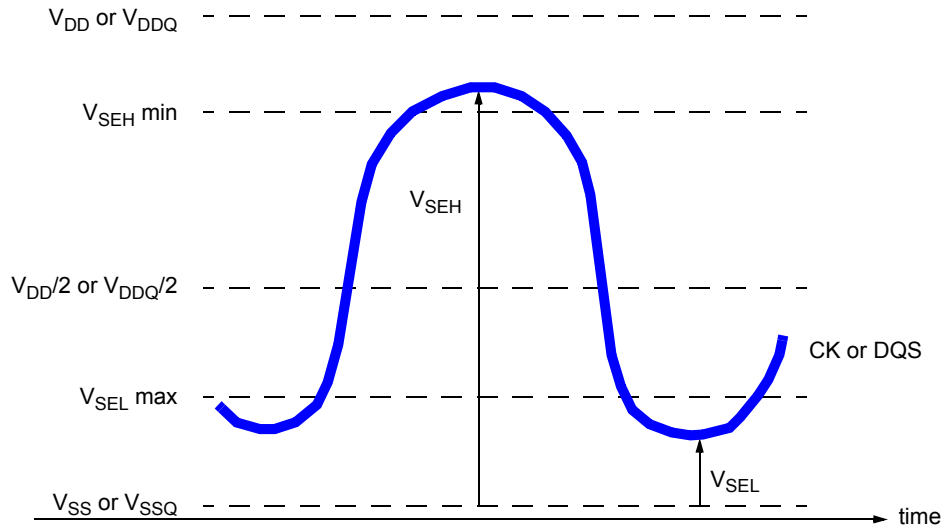

Figure 3 : Single-ended requirement for differential signals.

Note that while ADD/CMD and DQ signal requirements are with respect to  $V_{\text{REF}}$ , the single-ended components of differential signals have a requirement with respect to  $V_{\text{DD}}/2$ ; this is nominally the same. The transition of single-ended signals through the ac-levels is used to measure setup time. For single-ended components of differential signals the requirement to reach  $V_{\text{SELmax}}$ ,  $V_{\text{SEHmin}}$  has no bearing on timing, but adds a restriction on the common mode characteristics of these signals.

[ Table 11 ] Single ended levels for CK, DQS, DQSL, DQSU,  $\overline{\text{CK}}$ ,  $\overline{\text{DQS}}$ ,  $\overline{\text{DQSL}}$  or  $\overline{\text{DQSU}}$

Symbol	Parameter	DDR3-800/1066/1333/1600		Unit	Notes
		Min	Max		
$V_{\text{SEH}}$	Single-ended high-level for strobes	$(V_{\text{DD}}/2)+0.175$	Note3	V	1, 2
	Single-ended high-level for CK, $\overline{\text{CK}}$	$(V_{\text{DD}}/2)+0.175$	Note3	V	1, 2
$V_{\text{SEL}}$	Single-ended low-level for strobes	Note3	$(V_{\text{DD}}/2)-0.175$	V	1, 2
	Single-ended low-level for CK, $\overline{\text{CK}}$	Note3	$(V_{\text{DD}}/2)-0.175$	V	1, 2

Notes:

- For CK,  $\overline{\text{CK}}$  use  $V_{\text{IH}}/V_{\text{IL(AC)}}$  of ADD/CMD; for strobes (DQS,  $\overline{\text{DQS}}$ , DQSL,  $\overline{\text{DQSL}}$ , DQSU,  $\overline{\text{DQSU}}$ ) use  $V_{\text{IH}}/V_{\text{IL(AC)}}$  of DQs.
- $V_{\text{IH(AC)}}/V_{\text{IL(AC)}}$  for DQs is based on  $V_{\text{REFDQ}}$ ;  $V_{\text{IH(AC)}}/V_{\text{IL(AC)}}$  for ADD/CMD is based on  $V_{\text{REFCA}}$ ; if a reduced ac-high or ac-low level is used for a signal group, then the reduced level applies also here
- These values are not defined, however they single-ended signals CK,  $\overline{\text{CK}}$ , DQS,  $\overline{\text{DQS}}$ , DQSL,  $\overline{\text{DQSL}}$ , DQSU,  $\overline{\text{DQSU}}$  need to be within the respective limits ( $V_{\text{IH(DC)max}}$ ,  $V_{\text{IL(DC)min}}$ ) for single-ended signals as well as the limitations for overshoot and undershoot. Refer to "Overshoot and Undershoot Specification"



### 8.4 Differential Input Cross Point Voltage

To guarantee tight setup and hold times as well as output skew parameters with respect to clock and strobe, each cross point voltage of differential input signals (CK,  $\overline{CK}$  and DQS,  $\overline{DQS}$ ) must meet the requirements in below table. The differential input cross point voltage  $V_{IX}$  is measured from the actual cross point of true and complement signal to the mid level between of  $V_{DD}$  and  $V_{SS}$ .

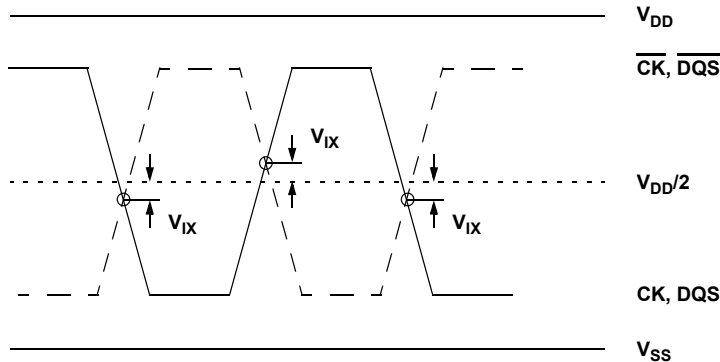

Figure 4.  $V_{IX}$  Definition

[ Table 12 ] Cross point voltage for differential input signals (CK, DQS)

Symbol	Parameter	DDR3-800/1066/1333/1600		Unit	Notes
		Min	Max		
$V_{IX}$	Differential Input Cross Point Voltage relative to $V_{DD}/2$ for CK, $\overline{CK}$	-150	150	mV	
$V_{IX}$	Differential Input Cross Point Voltage relative to $V_{DD}/2$ for DQS, $\overline{DQS}$	-175	175	mV	1

Note :

1. Extended range for  $V_{IX}$  is only allowed for clock and if single-ended clock input signals CK and  $\overline{CK}$  are monotonic, have a single-ended swing  $V_{SEL} / V_{SEH}$  of at least  $V_{DD}/2 \pm 250$  mV, and the differential slew rate of CK- $\overline{CK}$  is larger than 3 V/ ns. Refer to table 11 on page 17 for  $V_{SEL}$  and  $V_{SEH}$  standard values.

### 8.5 Slew Rate Definition for Single Ended Input Signals

See 14.3 "Address / Command Setup, Hold and Derating" for single-ended slew rate definitions for address and command signals.

See 14.4 "Data Setup, Hold and Slew Rate Derating" for single-ended slew rate definitions for data signals.  $t_{DH}$  nominal slew rate for a falling signal is defined as the slew rate between the last crossing of  $V_{IH}(DC)_{min}$  and the first crossing of  $V_{REF}$

### 8.6 Slew rate definition for Differential Input Signals

Input slew rate for differential signals (CK,  $\overline{CK}$  and DQS,  $\overline{DQS}$ ) are defined and measured as shown in Table 13 and Figure 5.

[ Table 13 ] Differential input slew rate definition

Description	Measured		Defined by
	From	To	
Differential input slew rate for rising edge (CK- $\overline{CK}$ and DQS- $\overline{DQS}$ )	$V_{ILDiffmax}$	$V_{IHDiffmin}$	$V_{IHDiffmin} - V_{ILDiffmax}$ Delta TRdiff
Differential input slew rate for falling edge (CK- $\overline{CK}$ and DQS- $\overline{DQS}$ )	$V_{IHDiffmin}$	$V_{ILDiffmax}$	$V_{IHDiffmin} - V_{ILDiffmax}$ Delta TFdiff

Note : The differential signal (i.e. CK -  $\overline{CK}$  and DQS -  $\overline{DQS}$ ) must be linear between these thresholds

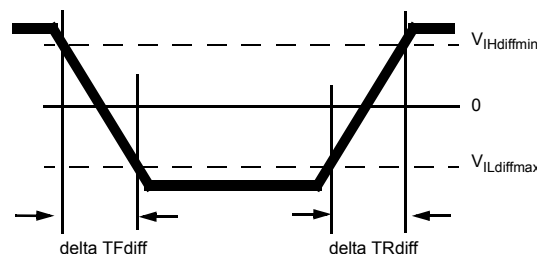

Figure 5. Differential Input Slew Rate definition for DQS,  $\overline{DQS}$  and CK,  $\overline{CK}$

## 9.0 AC and DC Output Measurement Levels

### 9.1 Single Ended AC and DC Output Levels

[ Table 14 ] Single Ended AC and DC output levels

Symbol	Parameter	DDR3-800/1066/1333/1600	Units	Notes
V <sub>OH(DC)</sub>	DC output high measurement level (for IV curve linearity)	0.8 x V <sub>DDQ</sub>	V	
V <sub>OM(DC)</sub>	DC output mid measurement level (for IV curve linearity)	0.5 x V <sub>DDQ</sub>	V	
V <sub>OL(DC)</sub>	DC output low measurement level (for IV curve linearity)	0.2 x V <sub>DDQ</sub>	V	
V <sub>OH(AC)</sub>	AC output high measurement level (for output SR)	V <sub>TT</sub> + 0.1 x V <sub>DDQ</sub>	V	1
V <sub>OL(AC)</sub>	AC output low measurement level (for output SR)	V <sub>TT</sub> - 0.1 x V <sub>DDQ</sub>	V	1

Note : 1. The swing of +/-0.1 x V<sub>DDQ</sub> is based on approximately 50% of the static single ended output high or low swing with a driver impedance of 40Ω and an effective test load of 25Ω to V<sub>TT</sub>=V<sub>DDQ</sub>/2.

### 9.2 Differential AC and DC Output Levels

[ Table 15 ] Differential AC and DC output levels

Symbol	Parameter	DDR3-800/1066/1333/1600	Units	Notes
V <sub>OHdiff(AC)</sub>	AC differential output high measurement level (for output SR)	+0.2 x V <sub>DDQ</sub>	V	1
V <sub>OLdiff(DC)</sub>	AC differential output low measurement level (for output SR)	-0.2 x V <sub>DDQ</sub>	V	1

Note : 1. The swing of +/-0.2xV<sub>DDQ</sub> is based on approximately 50% of the static single ended output high or low swing with a driver impedance of 40Ω and an effective test load of 25Ω to V<sub>TT</sub>=V<sub>DDQ</sub>/2 at each of the differential outputs.

### 9.3 Single Ended Output Slew Rate

With the reference load for timing measurements, output slew rate for falling and rising edges is defined and measured between V<sub>OL(AC)</sub> and V<sub>OH(AC)</sub> for single ended signals as shown in Table 16 and figure 6.

[ Table 16 ] Single Ended Output slew rate definition

Description	Measured		Defined by
	From	To	
Single ended output slew rate for rising edge	V <sub>OL(AC)</sub>	V <sub>OH(AC)</sub>	V <sub>OH(AC)</sub> -V <sub>OL(AC)</sub> Delta TRse
Single ended output slew rate for falling edge	V <sub>OH(AC)</sub>	V <sub>OL(AC)</sub>	V <sub>OH(AC)</sub> -V <sub>OL(AC)</sub> Delta TFse

Note : Output slew rate is verified by design and characterization, and may not be subject to production test.

[ Table 17 ] Single Ended Output slew rate

Parameter	Symbol	DDR3-800		DDR3-1066		DDR3-1333		DDR3-1600		Units
		Min	Max	Min	Max	Min	Max	Min	Max	
Single ended output slew rate	SRQse	2.5	5	2.5	5	2.5	5	TBD	5	V/ns

Description : SR : Slew Rate

Q : Query Output (like in DQ, which stands for Data-in, Query-Output

se : Single-ended Signals

For Ron = RZQ/7 setting

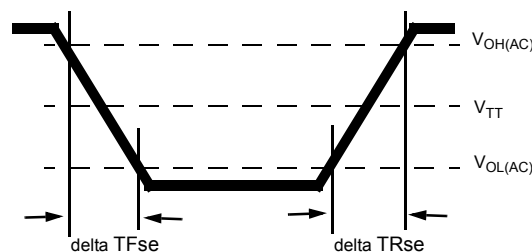

Figure 6. Single Ended Output Slew Rate definition

9.4 Differential Output Slew Rate

With the reference load for timing measurements, output slew rate for falling and rising edges is defined and measured between  $V_{OLdiff}(AC)$  and  $V_{OHdiff}(AC)$  for differential signals as shown in Table 18 and figure 7.

[ Table 18 ] Differential Output slew rate definition

Description	Measured		Defined by
	From	To	
Differential output slew rate for rising edge	$V_{OLdiff}(AC)$	$V_{OHdiff}(AC)$	$V_{OHdiff}(AC) - V_{OLdiff}(AC)$ Delta TRdiff
Differential output slew rate for falling edge	$V_{OHdiff}(AC)$	$V_{OLdiff}(AC)$	$V_{OHdiff}(AC) - V_{OLdiff}(AC)$ Delta TFdiff

Note : Output slew rate is verified by design and characterization, and may not be subject to production test.

[ Table 19 ] Differential Output slew rate

Parameter	Symbol	DDR3-800		DDR3-1066		DDR3-1333		DDR3-1600		Units
		Min	Max	Min	Max	Min	Max	Min	Max	
Differential output slew rate	SRQse	5	10	5	10	5	10	TBD	10	V/ns

Description : SR : Slew Rate

Q : Query Output (like in DQ, which stands for Data-in, Query-Output

diff : Single-ended Signals

For Ron = RZQ/7 setting

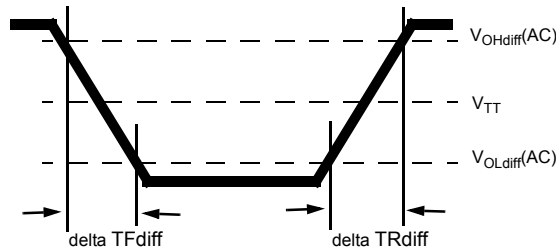

Figure 7. Differential Output Slew Rate definition

9.5 Reference Load for AC Timing and Output Slew Rate

Figure 8 represents the effective reference load of 25 ohms used in defining the relevant AC timing parameters of the device as well as output slew rate measurements.

It is not intended as a precise representation of any particular system environment or a depiction of the actual load presented by a production tester. System designers should use IBIS or other simulation tools to correlate the timing reference load to a system environment. Manufacturers correlate to their production test conditions, generally one or more coaxial transmission lines terminated at the tester electronics.

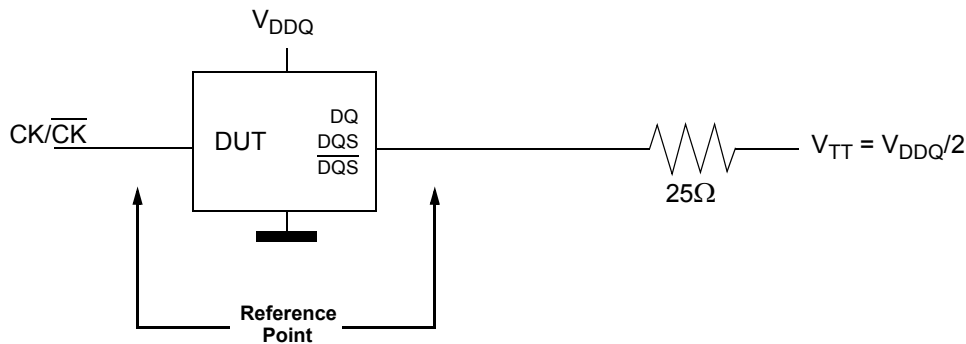

Figure 8. Reference Load for AC Timing and Output Slew Rate

9.6 Overshoot/Undershoot Specification

9.6.1 Address and Control Overshoot and Undershoot specifications

[ Table 20 ] AC overshoot/undershoot specification for Address and Control pins (A0-A12, BA0-BA2,  $\overline{\text{CS}}$ ,  $\overline{\text{RAS}}$ ,  $\overline{\text{CAS}}$ ,  $\overline{\text{WE}}$ ,  $\overline{\text{CKE}}$ , ODT)

Parameter	Specification				Unit
	DDR3-800	DDR3-1066	DDR3-1333	DDR3-1600	
Maximum peak amplitude allowed for overshoot area (See Figure 9)	0.4V	0.4V	0.4V	0.4V	V
Maximum peak amplitude allowed for undershoot area (See Figure 9)	0.4V	0.4V	0.4V	0.4V	V
Maximum overshoot area above $V_{DD}$ (See Figure 9)	0.67V-ns	0.5V-ns	0.4V-ns	0.33V-ns	V-ns
Maximum undershoot area below $V_{SS}$ (See Figure 9)	0.67V-ns	0.5V-ns	0.4V-ns	0.33V-ns	V-ns

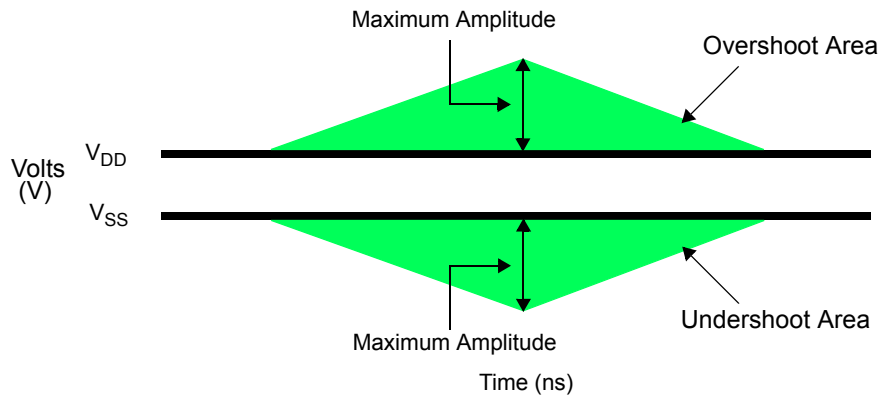

Figure 9. Address and Control Overshoot and Undershoot definition

9.6.2 Clock, Data, Strobe and Mask Overshoot and Undershoot specifications

[ Table 21 ] AC overshoot/undershoot specification for Clock, Data, Strobe and Mask ( $\overline{\text{DQ}}$ ,  $\overline{\text{DQS}}$ ,  $\overline{\text{DQS}}$ ,  $\overline{\text{DM}}$ ,  $\overline{\text{CK}}$ ,  $\overline{\text{CK}}$ )

Parameter	Specification				Unit
	DDR3-800	DDR3-1066	DDR3-1333	DDR3-1600	
Maximum peak amplitude allowed for overshoot area (See Figure 11)	0.4V	0.4V	0.4V	0.4V	V
Maximum peak amplitude allowed for undershoot area (See Figure 11)	0.4V	0.4V	0.4V	0.4V	V
Maximum overshoot area above $V_{DDQ}$ (See Figure 11)	0.25V-ns	0.19V-ns	0.15V-ns	0.13V-ns	V-ns
Maximum undershoot area below $V_{SSQ}$ (See Figure 11)	0.25V-ns	0.19V-ns	0.15V-ns	0.13V-ns	V-ns

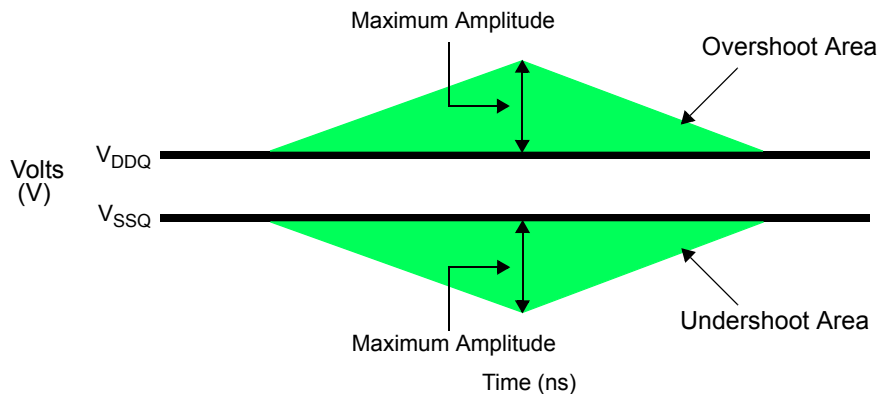

Figure 10. Clock, Data, Strobe and Mask Overshoot and Undershoot definition

9.7 34 ohm Output Driver DC Electrical Characteristics

A functional representation of the output buffer is shown below. Output driver impedance RON is defined by the value of external reference resistor RZQ as follows:

$RON_{34} = RZQ/7$  (Nominal 34ohms +/- 10% with nominal RZQ=240ohm)  
 $RON_{40} = RZQ/6$  (Nominal 40ohms +/- 10% with nominal RZQ=240ohm)

The individual Pull-up and Pull-down resistors (RONpu and RONpd) are defined as follows

$RON_{pu} = \frac{V_{DDQ} - V_{OUT}}{|I_{out}|}$  under the condition that RONpd is turned off  
 $RON_{pd} = \frac{V_{OUT}}{|I_{out}|}$  under the condition that RONpu is turned off

Output Driver : Definition of Voltages and Currents

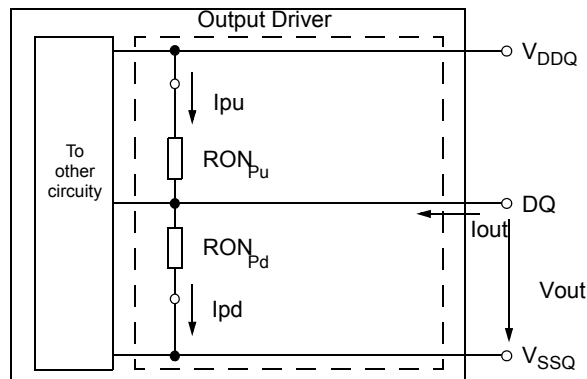

Figure 11. Output Driver : Definition of Voltages and Currents

[ Table 22 ] Output Driver DC Electrical Characteristics, assuming RZQ=240 ohms ;  
entire operating temperature range; after proper ZQ calibration

RONnom	Resistor	Vout	Min	Nom	Max	Units	Notes
34Ohms	RON34pd	$V_{OLdc} = 0.2 \times V_{DDQ}$	0.6	1.0	1.1	RZQ/7	1,2,3
		$V_{OMdc} = 0.5 \times V_{DDQ}$	0.9	1.0	1.1		1,2,3
		$V_{OHdc} = 0.8 \times V_{DDQ}$	0.9	1.0	1.4		1,2,3
	RON34pu	$V_{OLdc} = 0.2 \times V_{DDQ}$	0.9	1.0	1.4		1,2,3
		$V_{OMdc} = 0.5 \times V_{DDQ}$	0.9	1.0	1.1		1,2,3
		$V_{OHdc} = 0.8 \times V_{DDQ}$	0.6	1.0	1.1		1,2,3
40Ohms	RON40pd	$V_{OLdc} = 0.2 \times V_{DDQ}$	0.6	1.0	1.1	RZQ/6	1,2,3
		$V_{OMdc} = 0.5 \times V_{DDQ}$	0.9	1.0	1.1		1,2,3
		$V_{OHdc} = 0.8 \times V_{DDQ}$	0.9	1.0	1.4		1,2,3
	RON40pu	$V_{OLdc} = 0.2 \times V_{DDQ}$	0.9	1.0	1.4		1,2,3
		$V_{OMdc} = 0.5 \times V_{DDQ}$	0.9	1.0	1.1		1,2,3
		$V_{OHdc} = 0.8 \times V_{DDQ}$	0.6	1.0	1.1		1,2,3
Mismatch between Pull-up and Pull-down, MMpupd		$V_{OMdc} = 0.5 \times V_{DDQ}$	-10		10	%	1,2,4

Note :

- The tolerance limits are specified after calibration with stable voltage and temperature. For the behavior of the tolerance limits if temperature or voltage changes after calibration, see following section on voltage and temperature sensitivity
- The tolerance limits are specified under the condition that  $V_{DDQ} = V_{DD}$  and that  $V_{SSQ} = V_{SS}$
- Pull-down and pull-up output driver impedance are recommended to be calibrated at  $0.5 \times V_{DDQ}$ . Other calibration schemes may be used to achieve the linearity spec shown above, e.g. calibration at  $0.2 \times V_{DDQ}$  and  $0.8 \times V_{DDQ}$
- Measurement definition for mismatch between pull-up and pull-down, MMpupd: Measure RONpu and RONpd, both at  $0.5 \times V_{DDQ}$ :

$MMpupd = \frac{RON_{pu} - RON_{pd}}{RON_{nom}} \times 100$

9.7.1 Output Drive Temperature and Voltage sensitivity

If temperature and/or voltage change after calibration, the tolerance limits widen according to table 23 and 24.

$\Delta T = T - T(@\text{calibration})$ ;  $\Delta V = V_{DDQ} - V_{DDQ}(@\text{calibration})$ ;  $V_{DD} = V_{DDQ}$

\* $dR_{ONdT}$  and  $dR_{ONdV}$  are not subject to production test but are verified by design and characterization

[ Table 23 ] Output Driver Sensitivity Definition

	Min	Max	Units
RONPU@VOHDC	$0.6 - dR_{ONdTH} *  \Delta T  - dR_{ONdVH} *  \Delta V $	$1.1 + dR_{ONdTH} *  \Delta T  + dR_{ONdVH} *  \Delta V $	RZQ/7
RON@VOMDC	$0.9 - dR_{ONdTM} *  \Delta T  - dR_{ONdVM} *  \Delta V $	$1.1 + dR_{ONdTM} *  \Delta T  + dR_{ONdVM} *  \Delta V $	RZQ/7
RONPD@VOLDC	$0.6 - dR_{ONdTL} *  \Delta T  - dR_{ONdVL} *  \Delta V $	$1.1 + dR_{ONdTL} *  \Delta T  + dR_{ONdVL} *  \Delta V $	RZQ/7

[ Table 24 ] Output Driver Voltage and Temperature Sensitivity

Speed Bin	800/1066/1333		1600		Units
	Min	Max	Min	Max	
$dR_{ONdTM}$	0	1.5	0	1.5	%/°C
$dR_{ONdVM}$	0	0.15	0	0.13	%/mV
$dR_{ONdTL}$	0	1.5	0	1.5	%/°C
$dR_{ONdVL}$	0	0.15	0	0.13	%/mV
$dR_{ONdTH}$	0	1.5	0	1.5	%/°C
$dR_{ONdVH}$	0	0.15	0	0.13	%/mV

9.8 On-Die Termination (ODT) Levels and I-V Characteristics

On-Die Termination effective resistance  $RTT$  is defined by bits A9, A6 and A2 of MR1 register.

ODT is applied to the DQ, DM, DQS/DQS and TDQS, TDQS (x8 devices only) pins.

A functional representation of the on-die termination is shown below. The individual pull-up and pull-down resistors ( $RTT_{pu}$  and  $RTT_{pd}$ ) are defined as follows :

$$RTT_{pu} = \frac{V_{DDQ} - V_{OUT}}{|I_{out}|} \quad \text{under the condition that } RTT_{pd} \text{ is turned off}$$

$$RTT_{pd} = \frac{V_{OUT}}{|I_{out}|} \quad \text{under the condition that } RTT_{pu} \text{ is turned off}$$

On-Die Termination : Definition of Voltages and Currents

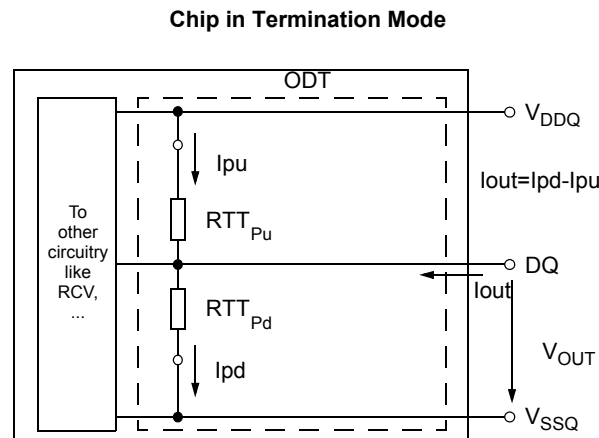

Figure 12. On-Die Termination : Definition of Voltages and Currents

9.8.1 ODT DC electrical characteristics

Table 26 provides an overview of the ODT DC electrical characteristics. The values for  $RTT_{60pd120}$ ,  $RTT_{60pu120}$ ,  $RTT_{120pd240}$ ,  $RTT_{120pu240}$ ,  $RTT_{40pd80}$ ,  $RTT_{40pu80}$ ,  $RTT_{30pd60}$ ,  $RTT_{30pu60}$ ,  $RTT_{20pd40}$ ,  $RTT_{20pu40}$  are not specification requirements, but can be used as design guide lines:

[ Table 25 ] ODT DC Electrical characteristics, assuming  $RZQ=240\ \text{ohm} \pm 1\%$  entire operating temperature range ; after proper ZQ calibration.

MR1 (A9,A6,A2)	RTT	RESISTOR	Vout	Min	Nom	Max	Unit	Notes		
(0,1,0)	120 ohm	RTT <sub>120pd240</sub>	$V_{OL}(DC) 0.2XV_{DDQ}$	0.6	1.0	1.1	R <sub>ZQ</sub>	1,2,3,4		
			$0.5XV_{DDQ}$	0.9	1.0	1.1	R <sub>ZQ</sub>	1,2,3,4		
			$V_{OH}(DC) 0.8XV_{DDQ}$	0.9	1.0	1.4	R <sub>ZQ</sub>	1,2,3,4		
		RTT <sub>120pu240</sub>	$V_{OL}(DC) 0.2XV_{DDQ}$	0.9	1.0	1.4	R <sub>ZQ</sub>	1,2,3,4		
			$0.5XV_{DDQ}$	0.9	1.0	1.1	R <sub>ZQ</sub>	1,2,3,4		
			$V_{OH}(DC) 0.8XV_{DDQ}$	0.6	1.0	1.1	R <sub>ZQ</sub>	1,2,3,4		
		RTT <sub>120</sub>	$V_{IL}(AC) \text{ to } V_{IH}(AC)$	0.9	1.0	1.6	R <sub>ZQ</sub> /2	1,2,5		
		(0,0,1)	60 ohm	RTT <sub>60pd240</sub>	$V_{OL}(DC) 0.2XV_{DDQ}$	0.6	1.0	1.1	R <sub>ZQ</sub> /2	1,2,3,4
					$0.5XV_{DDQ}$	0.9	1.0	1.1	R <sub>ZQ</sub> /2	1,2,3,4
$V_{OH}(DC) 0.8XV_{DDQ}$	0.9				1.0	1.4	R <sub>ZQ</sub> /2	1,2,3,4		
RTT <sub>60pu240</sub>	$V_{OL}(DC) 0.2XV_{DDQ}$			0.9	1.0	1.4	R <sub>ZQ</sub> /2	1,2,3,4		
	$0.5XV_{DDQ}$			0.9	1.0	1.1	R <sub>ZQ</sub> /2	1,2,3,4		
	$V_{OH}(DC) 0.8XV_{DDQ}$			0.6	1.0	1.1	R <sub>ZQ</sub> /2	1,2,3,4		
RTT <sub>60</sub>	$V_{IL}(AC) \text{ to } V_{IH}(AC)$			0.9	1.0	1.6	R <sub>ZQ</sub> /4	1,2,5		
(0,1,1)	40 ohm			RTT <sub>40pd240</sub>	$V_{OL}(DC) 0.2XV_{DDQ}$	0.6	1.0	1.1	R <sub>ZQ</sub> /3	1,2,3,4
					$0.5XV_{DDQ}$	0.9	1.0	1.1	R <sub>ZQ</sub> /3	1,2,3,4
		$V_{OH}(DC) 0.8XV_{DDQ}$	0.9		1.0	1.4	R <sub>ZQ</sub> /3	1,2,3,4		
		RTT <sub>40pu240</sub>	$V_{OL}(DC) 0.2XV_{DDQ}$	0.9	1.0	1.4	R <sub>ZQ</sub> /3	1,2,3,4		
			$0.5XV_{DDQ}$	0.9	1.0	1.1	R <sub>ZQ</sub> /3	1,2,3,4		
			$V_{OH}(DC) 0.8XV_{DDQ}$	0.6	1.0	1.1	R <sub>ZQ</sub> /3	1,2,3,4		
		RTT <sub>40</sub>	$V_{IL}(AC) \text{ to } V_{IH}(AC)$	0.9	1.0	1.6	R <sub>ZQ</sub> /6	1,2,5		
		(1,0,1)	30 ohm	RTT <sub>60pd240</sub>	$V_{OL}(DC) 0.2XV_{DDQ}$	0.6	1.0	1.1	R <sub>ZQ</sub> /4	1,2,3,4
					$0.5XV_{DDQ}$	0.9	1.0	1.1	R <sub>ZQ</sub> /4	1,2,3,4
$V_{OH}(DC) 0.8XV_{DDQ}$	0.9				1.0	1.4	R <sub>ZQ</sub> /4	1,2,3,4		
RTT <sub>60pu240</sub>	$V_{OL}(DC) 0.2XV_{DDQ}$			0.9	1.0	1.4	R <sub>ZQ</sub> /4	1,2,3,4		
	$0.5XV_{DDQ}$			0.9	1.0	1.1	R <sub>ZQ</sub> /4	1,2,3,4		
	$V_{OH}(DC) 0.8XV_{DDQ}$			0.6	1.0	1.1	R <sub>ZQ</sub> /4	1,2,3,4		
RTT <sub>60</sub>	$V_{IL}(AC) \text{ to } V_{IH}(AC)$			0.9	1.0	1.6	R <sub>ZQ</sub> /8	1,2,5		
(1,0,0)	20 ohm			RTT <sub>60pd240</sub>	$V_{OL}(DC) 0.2XV_{DDQ}$	0.6	1.0	1.1	R <sub>ZQ</sub> /6	1,2,3,4
					$0.5XV_{DDQ}$	0.9	1.0	1.1	R <sub>ZQ</sub> /6	1,2,3,4
		$V_{OH}(DC) 0.8XV_{DDQ}$	0.9		1.0	1.4	R <sub>ZQ</sub> /6	1,2,3,4		
		RTT <sub>60pu240</sub>	$V_{OL}(DC) 0.2XV_{DDQ}$	0.9	1.0	1.4	R <sub>ZQ</sub> /6	1,2,3,4		
			$0.5XV_{DDQ}$	0.9	1.0	1.1	R <sub>ZQ</sub> /6	1,2,3,4		
			$V_{OH}(DC) 0.8XV_{DDQ}$	0.6	1.0	1.1	R <sub>ZQ</sub> /6	1,2,3,4		
		RTT <sub>60</sub>	$V_{IL}(AC) \text{ to } V_{IH}(AC)$	0.9	1.0	1.6	R <sub>ZQ</sub> /12	1,2,5		
		Deviation of $V_M$ w.r.t $V_{DDQ}/2$ , $\Delta V_M$				-5		5	%	1,2,5,6

**Note :**

1. The tolerance limits are specified after calibration with stable voltage and temperature. For the behavior of the tolerance limits if temperature or voltage changes after calibration, see following section on voltage and temperature sensitivity
2. The tolerance limits are specified under the condition that  $V_{DDQ} = V_{DD}$  and that  $V_{SSQ} = V_{SS}$
3. Pull-down and pull-up ODT resistors are recommended to be calibrated at  $0.5XV_{DDQ}$ . Other calibration schemes may be used to achieve the linearity spec shown above, e.g. calibration at  $0.2XV_{DDQ}$  and  $0.8XV_{DDQ}$ .
4. Not a specification requirement, but a design guide line
5. Measurement definition for RTT:  
Apply  $V_{IH}(AC)$  to pin under test and measure current  $I(V_{IH}(AC))$ , then apply  $V_{IL}(AC)$  to pin under test and measure current  $I(V_{IL}(AC))$  respectively

$$RTT = \frac{V_{IH}(AC) - V_{IL}(AC)}{I(V_{IH}(AC)) - I(V_{IL}(AC))}$$

6. Measurement definition for  $V_M$  and  $\Delta V_M$  : Measure voltage ( $V_M$ ) at test pin (midpoint) with no load

$$\Delta V_M = \left( \frac{2 \times V_M}{V_{DDQ}} - 1 \right) \times 100$$

**9.8.2 ODT Temperature and Voltage sensitivity**

If temperature and/or voltage change after calibration, the tolerance limits widen according to table below

$\Delta T = T - T(@\text{calibration})$ ;  $\Delta V = V_{DDQ} - V_{DDQ}(@\text{calibration})$ ;  $V_{DD} = V_{DDQ}$

**[ Table 26 ] ODT Sensitivity Definition**

	Min	Max	Units
RTT	$0.9 - dR_{TTdT} *  \Delta T  - dR_{TTdV} *  \Delta V $	$1.6 + dR_{TTdT} *  \Delta T  + dR_{TTdV} *  \Delta V $	RZQ/2,4,6,8,12

**[ Table 27 ] ODT Voltage and Temperature Sensitivity**

	Min	Max	Units
$dR_{TTdT}$	0	1.5	%/°C
$dR_{TTdV}$	0	0.15	%/mV

These parameters may not be subject to production test. They are verified by design and characterization.



9.9 ODT Timing Definitions

9.9.1 Test Load for ODT Timings

Different than for timing measurements, the reference load for ODT timings is defined in Figure 13.

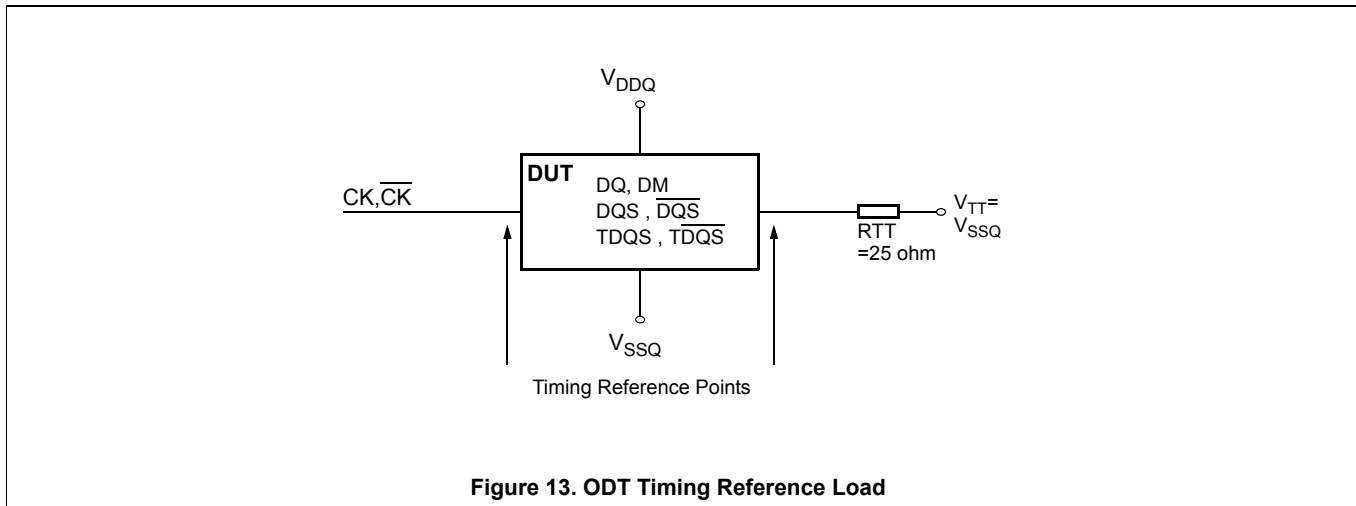

9.9.2 ODT Timing Definition

Definitions for tAON, tAONPD, tAOF, tAOFPD and tADC are provided in Table 28 and subsequent figures. Measurement reference settings are provided in Table 29.

[ Table 28 ] ODT Timing Definitions

Symbol	Begin Point Definition	End Point Definition	Figure
tAON	Rising edge of CK - CK-bar defined by the end point of ODTLon	Extrapolated point at VSSQ	Figure 14
tAONPD	Rising edge of CK - CK-bar with ODT being first registered high	Extrapolated point at VSSQ	Figure 15
tAOF	Rising edge of CK - CK-bar defined by the end point of ODTLoff	End point: Extrapolated point at VRTT_Nom	Figure 16
tAOFPD	Rising edge of CK - CK-bar with ODT being first registered low	End point: Extrapolated point at VRTT_Nom	Figure 17
tADC	Rising edge of CK - CK-bar defined by the end point of ODTLcnw, ODTLcwn4 of ODTLcwn8	End point: Extrapolated point at VRTT_Wr and VRTT_Nom respectively	Figure 18

[ Table 29 ] Reference Settings for ODT Timing Measurements

Measured Parameter	RTT_Nom Setting	RTT_Wr Setting	Vsw1[V]	Vsw2[V]	Note
tAON	RzQ/4	NA	0.05	0.10	
	RzQ/12	NA	0.10	0.20	
tAONPD	RzQ/4	NA	0.05	0.10	
	RzQ/12	NA	0.10	0.20	
tAOF	RzQ/4	NA	0.05	0.10	
	RzQ/12	NA	0.10	0.20	
tAOFPD	RzQ/4	NA	0.05	0.10	
	RzQ/12	NA	0.10	0.20	
tADC	RzQ/12	RzQ/2	0.20	0.30	

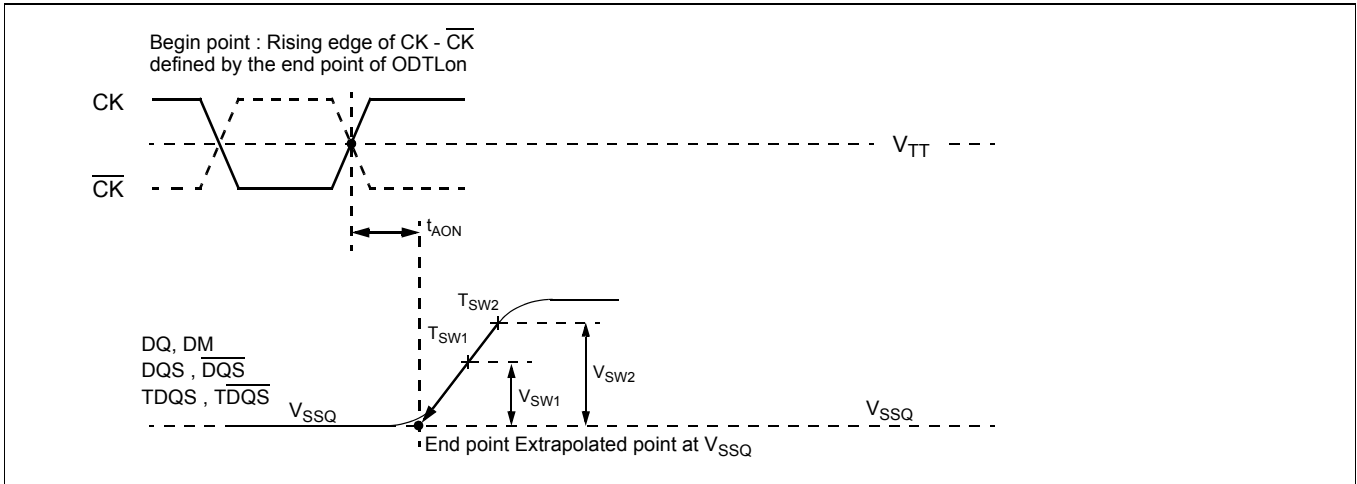

Figure 14. Definition of  $t_{\text{AON}}$

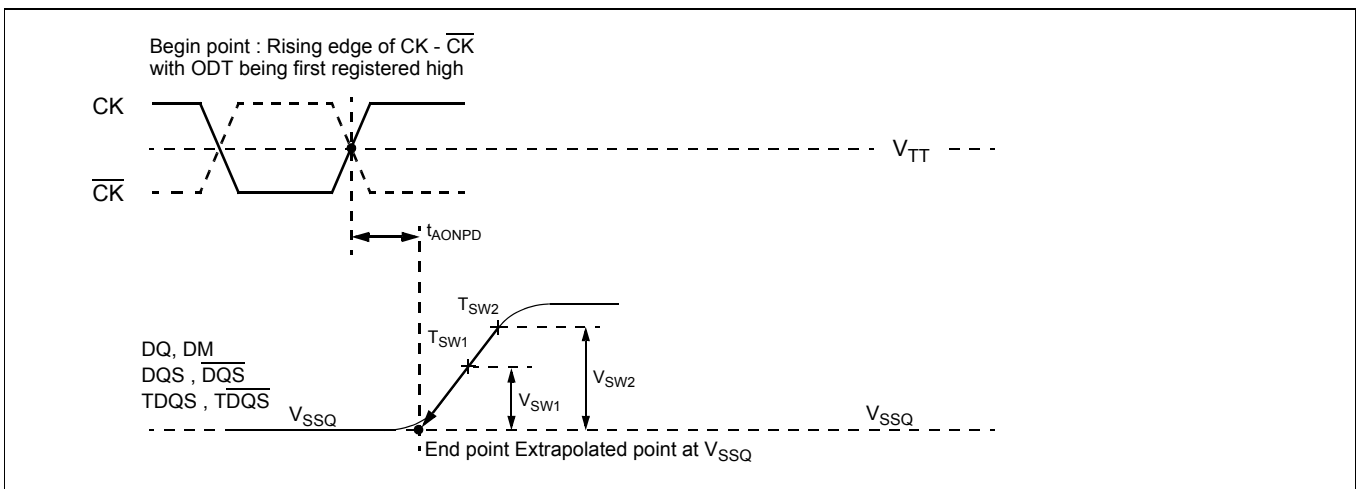

Figure 15. Definition of  $t_{\text{AONPD}}$

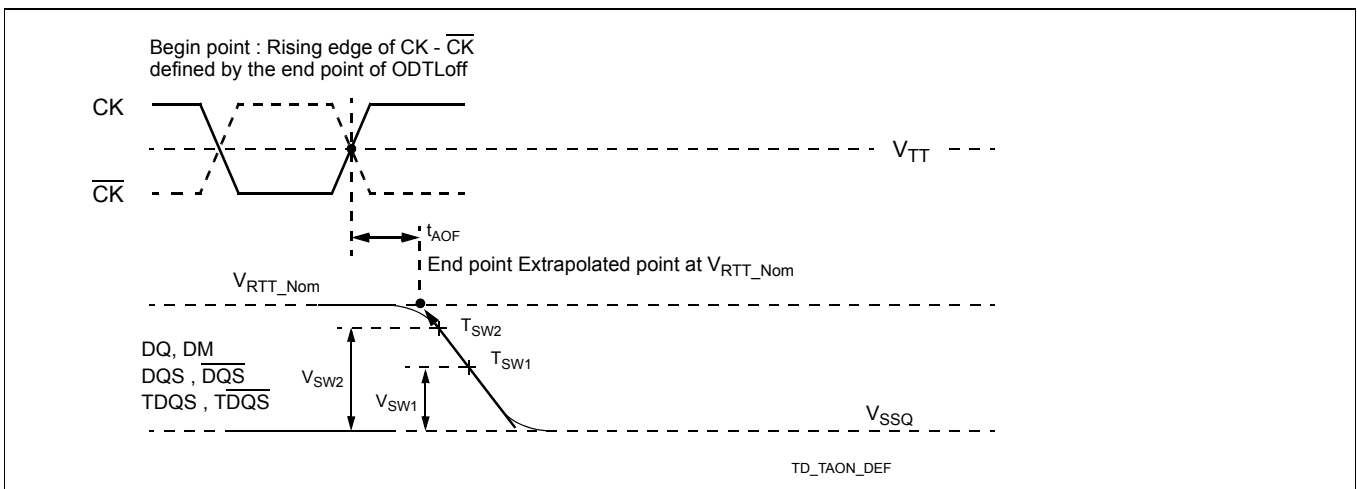

Figure 16. Definition of  $t_{\text{AOF}}$

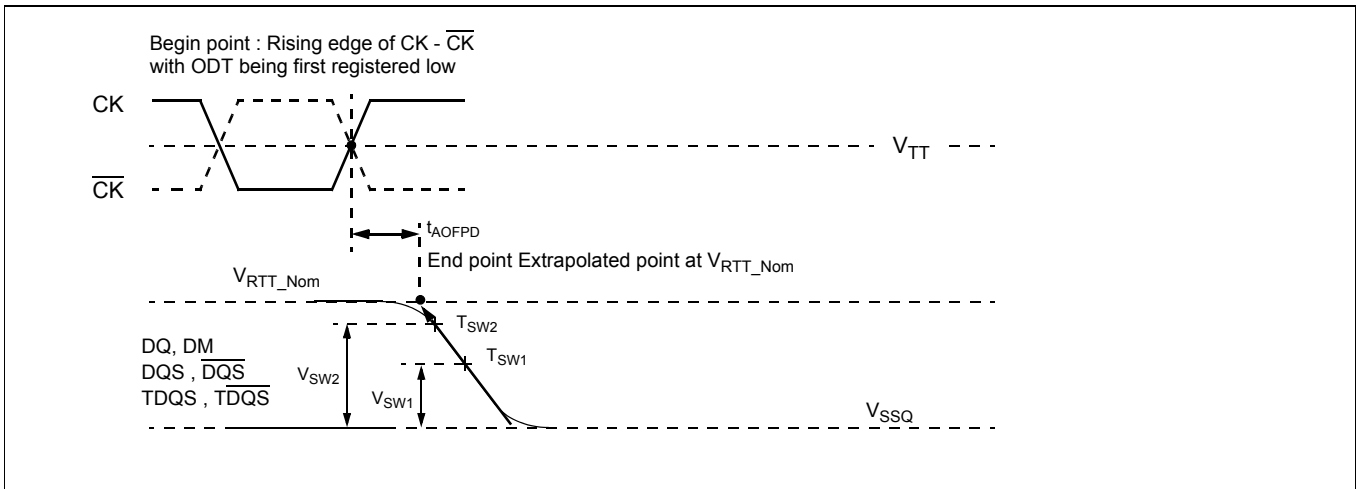

Figure 17. Definition of  $t_{\text{AOFPD}}$

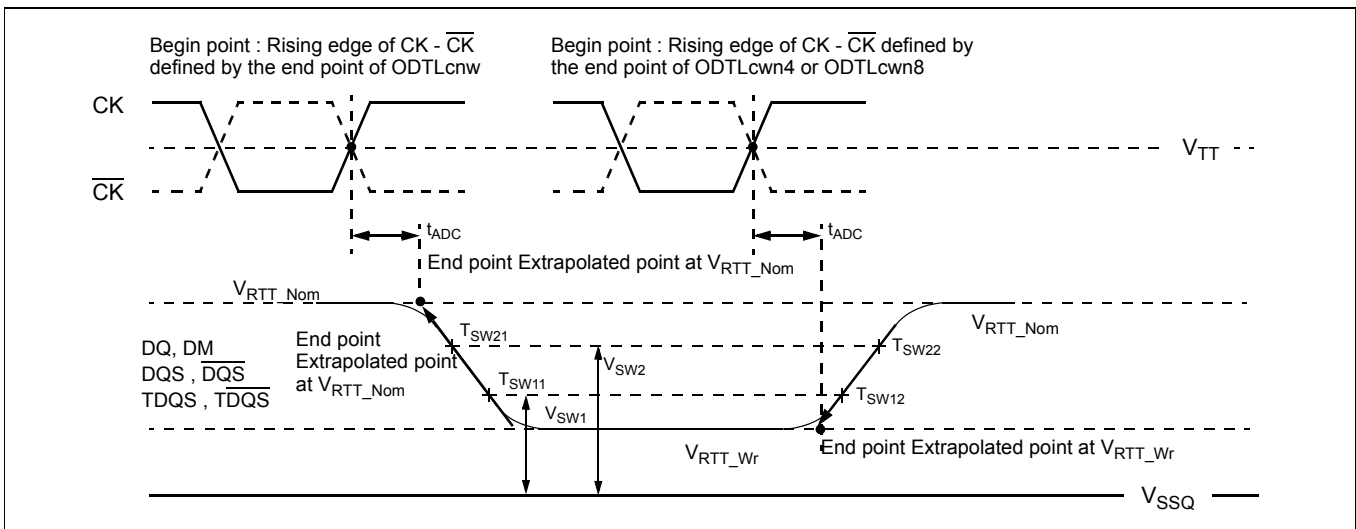

Figure 18. Definition of  $t_{\text{ADC}}$

## 10.0 IDD Specification Parameters and Test Conditions

### 10.1 IDD Measurement Conditions

In this chapter, IDD and IDDQ measurement conditions such as test load and patterns are defined. Figure 19 shows the setup and test load for IDD and IDDQ measurements.

- **IDD currents** (such as IDD0, IDD1, IDD2N, IDD2NT, IDD2P0, IDD2P1, IDD2Q, IDD3N, IDD3P, IDD4R, IDD4W, IDD5B, IDD6, IDD6ET, IDD6TC and IDD7) are measured as time-averaged currents with all  $V_{DD}$  balls of the DDR3 SDRAM under test tied together. Any IDDQ current is not included in IDD currents.
- **IDDQ currents** (such as IDDQ2NT and IDDQ4R) are measured as time-averaged currents with all  $V_{DDQ}$  balls of the DDR3 SDRAM under test tied together. Any IDD current is not included in IDDQ currents.

**Attention** : IDDQ values cannot be directly used to calculate IO power of the DDR3 SDRAM. They can be used to support correlation of simulated IO power to actual IO power as outlined in Figure 20. In DRAM module application, IDDQ cannot be measured separately since  $V_{DD}$  and  $V_{DDQ}$  are using one merged-power layer in Module PCB.

**For IDD and IDDQ measurements, the following definitions apply :**

- "0" and "LOW" is defined as  $V_{IN} \leq V_{ILAC(max)}$ .
- "1" and "HIGH" is defined as  $V_{IN} \geq V_{IHAC(min)}$ .
- "FLOATING" is defined as inputs are  $V_{REF} = V_{DD} / 2$ .
- Timings used for IDD and IDDQ Measurement-Loop Patterns are provided in Table 30.
- Basic IDD and IDDQ Measurement Conditions are described in Table 31.
- Detailed IDD and IDDQ Measurement-Loop Patterns are described in Table 32 on page 33 through Table 39.
- IDD Measurements are done after properly initializing the DDR3 SDRAM. This includes but is not limited to setting  
RON = RZQ/7 (34 Ohm in MR1);  
Qoff = 0B (Output Buffer enabled in MR1);  
RTT\_Nom = RZQ/6 (40 Ohm in MR1);  
RTT\_Wr = RZQ/2 (120 Ohm in MR2);  
TDQS Feature disabled in MR1
- **Attention** : The IDD and IDDQ Measurement-Loop Patterns need to be executed at least one time before actual IDD or IDDQ measurement is started.
- Define  $\bar{D} = \{\overline{CS}, \overline{RAS}, \overline{CAS}, \overline{WE}\} := \{HIGH, LOW, LOW, LOW\}$
- Define  $\underline{D} = \{\underline{CS}, \underline{RAS}, \underline{CAS}, \underline{WE}\} := \{HIGH, HIGH, HIGH, HIGH\}$

Timing parameters are listed in the following table:

[ Table 30 ] Timing used for IDD and IDDQ Measured-Loop Patterns.

Parameter	Bin	DDR3-800		DDR3-1066			DDR3-1333				DDR3-1600				Unit
		5-5-5	6-6-6	6-6-6	7-7-7	8-8-8	7-7-7	8-8-8	9-9-9	10-10-10	8-8-8	9-9-9	10-10-10	11-11-11	
tCKmin(IDD)		2.5		1.875			1.5				1.25				ns
CL(IDD)		5	6	6	7	8	7	8	9	10	8	9	10	11	nCK
tRCDmin(IDD)		5	6	6	7	8	7	8	9	10	8	9	10	11	nCK
tRCmin(IDD)		20	21	26	27	28	31	32	33	34	36	37	38	39	nCK
tRASmin(IDD)		15		20			24				28				nCK
tRPmin(IDD)		5	6	6	7	8	7	8	9	10	8	9	10	11	nCK
tFAW(IDD)	x4/x8	16		20			20				24				nCK
	x16	20		27			30				32				nCK
tRRD(IDD)	x4/x8	4		4			4				5				nCK
	x16	4		6			5				6				nCK
tRFC(IDD) - 512Mb		36		48			60				72				nCK
tRFC(IDD) - 1Gb		44		59			74				88				nCK
tRFC(IDD) - 2Gb		64		86			107				128				nCK
tRFC(IDD) - 4Gb		120		160			200				240				nCK
tRFC(IDD) - 8Gb		140		187			234				280				nCK

[ Table 31 ] Basic IDD and IDDQ Measurement Conditions

Symbol	Description
IDD0	<b>Operating One Bank Active-Precharge Current</b> CKE: High; External clock: On; tCK, nRC, nRAS, CL: see Table 30 ; BL: 8 <sup>a</sup> ; AL: 0; $\overline{CS}$ : High between ACT and PRE; Command, Address, Bank Address Inputs: partially toggling according to Table 32 ; Data IO: MID-LEVEL; DM:stable at 0; Bank Activity: Cycling with one bank active at a time: 0,0,1,1,2,2,... (see Table32); Output Buffer and RTT: Enabled in Mode Registers <sup>b</sup> ; ODT Signal: stable at 0; Pattern Details: see Table 32
IDD1	<b>Operating One Bank Active-Read-Precharge Current</b> CKE: High; External clock: On; tCK, nRC, nRAS, nRCD, CL: see Table 30 ; BL: 8 <sup>a</sup> ; AL: 0; $\overline{CS}$ : High between ACT, RD and PRE; Command, Address, Bank Address Inputs, Data IO: partially toggling according to Table 33 ; DM:stable at 0; Bank Activity: Cycling with one bank active at a time: 0,0,1,1,2,2,... (see Table33); Output Buffer and RTT: Enabled in Mode Registers <sup>b</sup> ; ODT Signal: stable at 0; Pattern Details: see Table 33
IDD2N	<b>Precharge Standby Current</b> CKE: High; External clock: On; tCK, CL: see Table 30 ; BL: 8 <sup>a</sup> ; AL: 0; $\overline{CS}$ : stable at 1; Command, Address, Bank Address Inputs: partially toggling according to Table 34 ; Data IO: MID-LEVEL; DM:stable at 0; Bank Activity: all banks closed; Output Buffer and RTT: Enabled in Mode Registers <sup>b</sup> ; ODT Signal: stable at 0; Pattern Details: see Table 34
DD2NT	<b>Precharge Standby ODT Current</b> CKE: High; External clock: On; tCK, CL: see Table 30 ; BL: 8 <sup>a</sup> ; AL: 0; $\overline{CS}$ : stable at 1; Command, Address, Bank Address Inputs: partially toggling according to Table 35 ; Data IO: MID-LEVEL;DM:stable at 0; Bank Activity: all banks closed; Output Buffer and RTT: Enabled in Mode Registers <sup>b</sup> ; ODT Signal: toggling according to Table 35 ; Pattern Details: see Table 35
DDQ2NT (optional)	<b>Precharge Standby ODT IDDQ Current</b> Same definition like for IDD2NT, however measuring IDDQ current instead of IDD current
IDD2P0	<b>Precharge Power-Down Current Slow Exit</b> CKE: Low; External clock: On; tCK, CL: see Table 30 ; BL: 8 <sup>a</sup> ; AL: 0; $\overline{CS}$ : stable at 1; Command, Address, Bank Address Inputs: stable at 0; Data IO: MID-LEVEL; DM:stable at 0; Bank Activity: all banks closed; Output Buffer and RTT: Enabled in Mode Registers <sup>b</sup> ; ODT Signal: stable at 0; Pecharge Power Down Mode: Slow Exit <sup>c</sup>
IDD2P1	<b>Precharge Power-Down Current Fast Exit</b> CKE: Low; External clock: On; tCK, CL: see Table 30 ; BL: 8 <sup>a</sup> ; AL: 0; $\overline{CS}$ : stable at 1; Command, Address, Bank Address Inputs: stable at 0; Data IO: MID-LEVEL; DM:stable at 0; Bank Activity: all banks closed; Output Buffer and RTT: Enabled in Mode Registers <sup>b</sup> ; ODT Signal: stable at 0; Pecharge Power Down Mode: Fast Exit <sup>c</sup>
IDD2Q	<b>Precharge Quiet Standby Current</b> CKE: High; External clock: On; tCK, CL: see Table 30 ; BL: 8 <sup>a</sup> ; AL: 0; $\overline{CS}$ : stable at 1; Command, Address, Bank Address Inputs: stable at 0; Data IO: MID-LEVEL; DM:stable at 0; Bank Activity: all banks closed; Output Buffer and RTT: Enabled in Mode Registers <sup>b</sup> ; ODT Signal: stable at 0
IDD3N	<b>Active Standby Current</b> CKE: High; External clock: On; tCK, CL: see Table 30 ; BL: 8 <sup>a</sup> ; AL: 0; $\overline{CS}$ : stable at 1; Command, Address, Bank Address Inputs: partially toggling according to Table 34 ; Data IO: MID-LEVEL; DM:stable at 0; Bank Activity: all banks open; Output Buffer and RTT: Enabled in Mode Registers <sup>b</sup> ; ODT Signal: stable at 0; Pattern Details: see Table 34
IDD3P	<b>Active Power-Down Current</b> CKE: Low; External clock: On; tCK, CL: see Table 30 ; BL: 8 <sup>a</sup> ; AL: 0; $\overline{CS}$ : stable at 1; Command, Address, Bank Address Inputs: stable at 0; Data IO: MID-LEVEL;DM:stable at 0; Bank Activity: all banks open; Output Buffer and RTT: Enabled in Mode Registers <sup>b</sup> ; ODT Signal: stable at 0
IDD4R	<b>Operating Burst Read Current</b> CKE: High; External clock: On; tCK, CL: see Table 30 ; BL: 8 <sup>a</sup> ; AL: 0; $\overline{CS}$ : High between RD; Command, Address, Bank Address Inputs: partially toggling according to Table 36 ; Data IO: seamless read data burst with different data between one burst and the next one according to Table 36 ; DM:stable at 0; Bank Activity: all banks open, RD commands cycling through banks: 0,0,1,1,2,2,... (see Table 7 on page 10); Output Buffer and RTT: Enabled in Mode Registers <sup>b</sup> ; ODT Signal: stable at 0; Pattern Details: see Table 36
IDDQ4R (optional)	<b>Operating Burst Read IDDQ Current</b> Same definition like for IDD4R, however measuring IDDQ current instead of IDD current
IDD4W	<b>Operating Burst Write Current</b> CKE: High; External clock: On; tCK, CL: see Table 30 ; BL: 8 <sup>a</sup> ; AL: 0; $\overline{CS}$ : High between WR; Command, Address, Bank Address Inputs: partially toggling according to Table 37 ; Data IO: seamless write data burst with different data between one burst and the next one according to Table 37; DM: stable at 0; Bank Activity: all banks open, WR commands cycling through banks: 0,0,1,1,2,2,... (see Table 37); Output Buffer and RTT: Enabled in Mode Registers <sup>b</sup> ; ODT Signal: stable at HIGH; Pattern Details: see Table 37
IDD5B	<b>Burst Refresh Current</b> CKE: High; External clock: On; tCK, CL, nRFC: see Table 30 ; BL: 8 <sup>a</sup> ; AL: 0; $\overline{CS}$ : High between REF; Command, Address, Bank Address Inputs: partially toggling according to Table 38 ; Data IO: MID-LEVEL;DM:stable at 0; Bank Activity: REF command every nRFC (see Table 38); Output Buffer and RTT: Enabled in Mode Registers <sup>b</sup> ; ODT Signal: stable at 0; Pattern Details: see Table 38
IDD6	<b>Self Refresh Current: Normal Temperature Range</b> TCASE: 0 - 85°C; Auto Self-Refresh (ASR): Disabled <sup>d</sup> ; Self-Refresh Temperature Range (SRT): Normal <sup>e</sup> ; CKE: Low; External clock: Off; CK and $\overline{CK}$ : LOW; CL: see Table 30 ; BL: 8 <sup>a</sup> ; AL: 0; $\overline{CS}$ , Command, Address, Bank Address, Data IO: MID-LEVEL;DM:stable at 0; Bank Activity: Self-Refresh operation; Output Buffer and RTT: Enabled in Mode Registers <sup>b</sup> ; ODT Signal: MID-LEVEL

[ Table 31 ] Basic IDD and IDDQ Measurement Conditions

Symbol	Description
IDD6ET	<b>Self-Refresh Current: Extended Temperature Range (optional)<sup>f)</sup></b> <b>TCASE:</b> 0 - 95°C; <b>Auto Self-Refresh (ASR):</b> Disabled <sup>d)</sup> ; <b>Self-Refresh Temperature Range (SRT):</b> Extended <sup>e)</sup> ; <b>CKE:</b> Low; <b>External clock:</b> Off; <b>CK and <math>\overline{CK}</math>:</b> LOW; <b>CL:</b> see Table 30 ; <b>BL:</b> 8 <sup>a)</sup> ; <b>AL:</b> 0; <b>CS,</b> Command, Address, Bank Address, <b>Data IO:</b> MID-LEVEL; <b>DM:</b> stable at 0; <b>Bank Activity:</b> Extended Temperature Self-Refresh operation; <b>Output Buffer and RTT:</b> Enabled in Mode Registers <sup>b)</sup> ; <b>ODT Signal:</b> MID-LEVEL
IDD6TC	<b>Auto Self-Refresh Current (optional)<sup>f)</sup></b> <b>TCASE:</b> 0 - 95°C; <b>Auto Self-Refresh (ASR):</b> Enabled <sup>d)</sup> ; <b>Self-Refresh Temperature Range (SRT):</b> Normal <sup>e)</sup> ; <b>CKE:</b> Low; <b>External clock:</b> Off; <b>CK and <math>\overline{CK}</math>:</b> LOW; <b>CL:</b> see Table 30 ; <b>BL:</b> 8 <sup>a)</sup> ; <b>AL:</b> 0; <b>CS,</b> Command, Address, Bank Address, <b>Data IO:</b> MID-LEVEL; <b>DM:</b> stable at 0; <b>Bank Activity:</b> Auto Self-Refresh operation; <b>Output Buffer and RTT:</b> Enabled in Mode Registers <sup>b)</sup> ; <b>ODT Signal:</b> MID-LEVEL
IDD7	<b>Operating Bank Interleave Read Current</b> <b>CKE:</b> High; <b>External clock:</b> On; tCK, nRC, nRAS, nRCD, nRRD, nFAW, <b>CL:</b> see Table 30 ; <b>BL:</b> 8 <sup>a), 9)</sup> ; <b>AL:</b> CL-1; <b>CS:</b> High between ACT and RDA; <b>Command, Address, Bank Address Inputs:</b> partially toggling according to Table 39 ; <b>Data IO:</b> read data bursts with different data between one burst and the next one according to Table 39 ; <b>DM:</b> stable at 0; <b>Bank Activity:</b> two times interleaved cycling through banks (0, 1, ...7) with different addressing, see Table 39 ; <b>Output Buffer and RTT:</b> Enabled in Mode Registers <sup>b)</sup> ; <b>ODT Signal:</b> stable at 0; <b>Pattern Details:</b> see Table 39

- a) Burst Length: BL8 fixed by MRS: set MR0 A[1,0]=00B
- b) Output Buffer Enable: set MR1 A[12] = 0B; set MR1 A[5,1] = 01B; RTT\_Nom enable: set MR1 A[9,6,2] = 011B; RTT\_Wr enable: set MR2 A[10,9] = 10B
- c) Pecharge Power Down Mode: set MR0 A12=0B for Slow Exit or MR0 A12=1B for Fast Exit
- d) Auto Self-Refresh (ASR): set MR2 A6 = 0B to disable or 1B to enable feature
- e) Self-Refresh Temperature Range (SRT): set MR2 A7=0B for normal or 1B for extended temperature range
- f) Refer to DRAM supplier data sheet and/or DIMM SPD to determine if optional features or requirements are supported by DDR3 SDRAM device

## 10.2 IDD Specifications definition

Editorial Instruction: Chapter 10.2 in JESD79-3B in principal stays at it is. See Reference Material at the end of this ballot.

Only the following changes will be done to Chapter 10.2:

Table 53 "IDD Specification Example 512M DDR3", add the following Rows:

- Between IDD2N and IDD2Q: Add 2 rows (one for x4/x8, one for x16) with a straddled cell for Symbol "IDD2NT".
- Between IDD2NT (as inserted with above bullet) and IDD2Q: Add 2 rows (one for x4/x8, one for x16) with a straddled cell for Symbol "IDDQ2NT".
- Between IDD4R and IDD4W: Add 3 rows (one for x4, one for x8 and one for x16) with a straddled cell for Symbol "IDDQ4R".

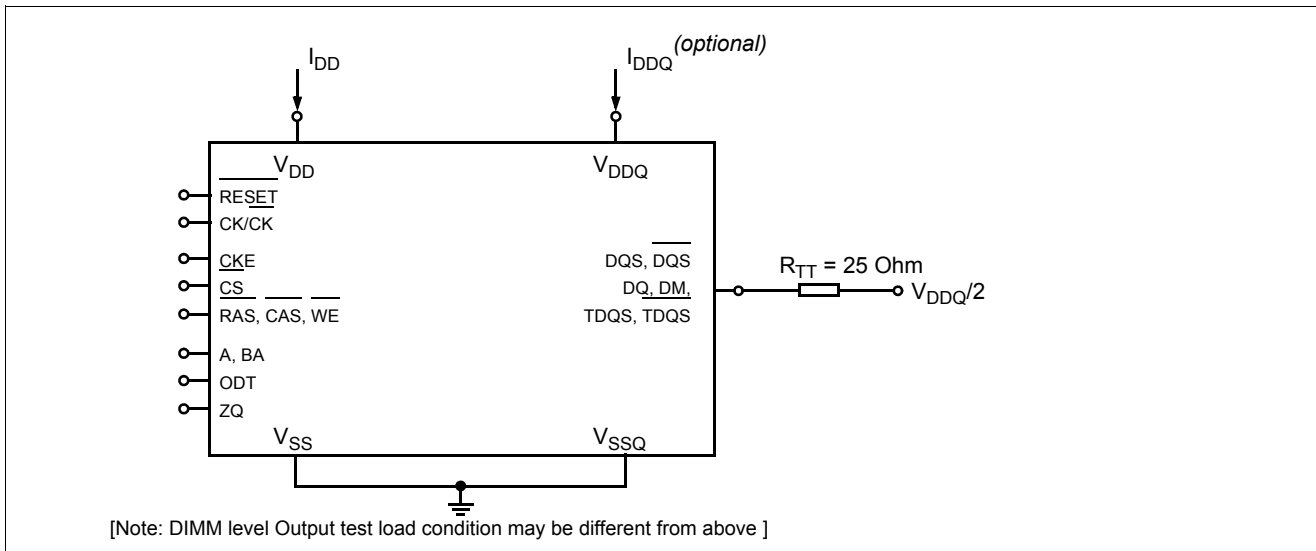

Figure 19 : Measurement Setup and Test Load for IDD and IDDQ (optional) Measurements

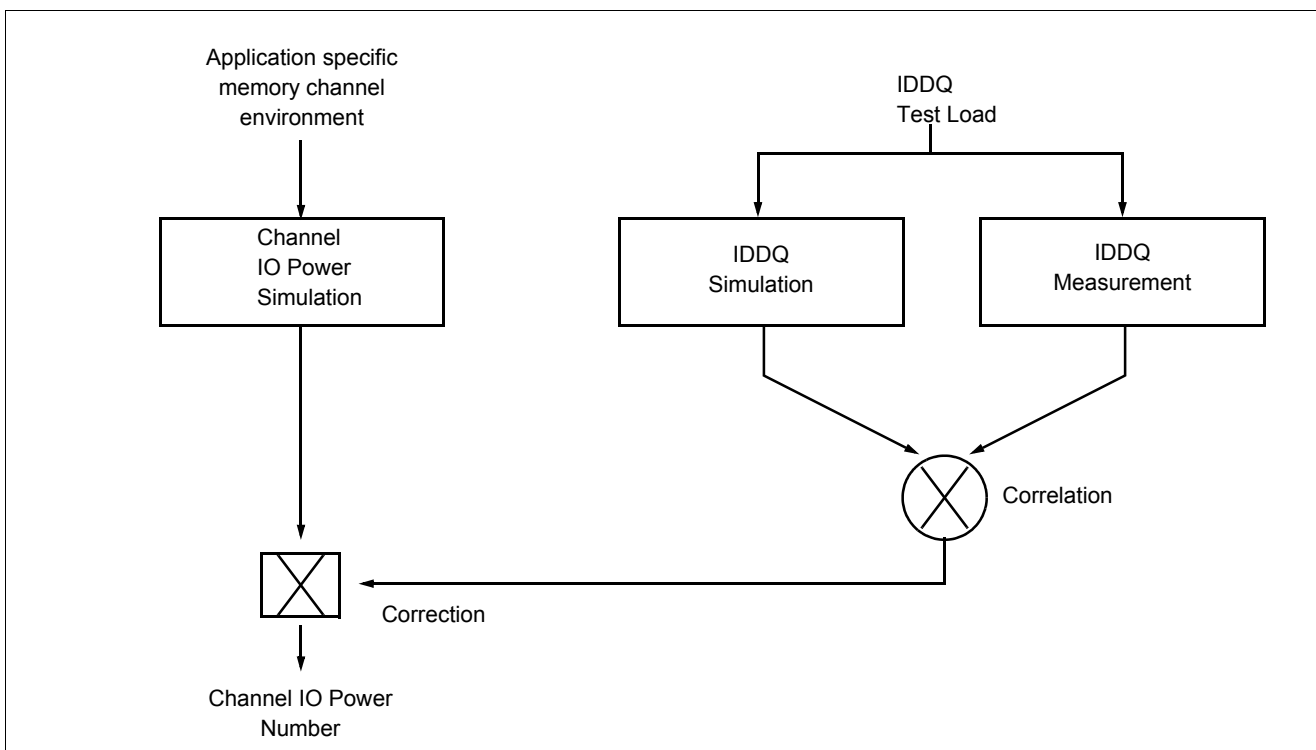

Figure 20 :Correlation from simulated Channel IO Power to actual Channel IO Power supported by IDDQ Measurement.

[ Table 32 ] IDD0 Measurement - Loop Pattern<sup>1</sup>

CK/CK	CKE	Sub-Loop	Cycle Number	Command	$\overline{\text{CS}}$	$\overline{\text{RAS}}$	$\overline{\text{CAS}}$	$\overline{\text{WE}}$	ODT	BA[2:0]	A[15:11]	A[10]	A[9:7]	A[6:3]	A[2:0]	Data <sup>2</sup>		
toggling	Static High	0	0	ACT	0	0	1	1	0	0	00	0	0	0	0	-		
			1,2	D, D	1	0	0	0	0	0	0	00	0	0	0	0	-	
			3,4	$\overline{\text{D}}, \overline{\text{D}}$	1	1	1	1	0	0	0	00	0	0	0	0	-	
			...	repeat pattern 1...4 until nRAS - 1, truncate if necessary														
			nRAS	PRE	0	0	1	0	0	0	0	00	0	0	0	0	-	
			...	repeat pattern 1...4 until nRC - 1, truncate if necessary														
			1*nRC + 0	ACT	0	0	1	1	0	0	00	0	0	F	0	-		
			1*nRC + 1, 2	D, D	1	0	0	0	0	0	0	00	0	F	0	-		
			1*nRC + 3, 4	$\overline{\text{D}}, \overline{\text{D}}$	1	1	1	1	0	0	00	0	0	F	0	-		
			...	repeat pattern 1...4 until 1*nRC + nRAS - 1, truncate if necessary														
			1*nRC + nRAS	PRE	0	0	1	0	0	0	0	00	0	F	0	-		
			...	repeat 1...4 until 2*nRC - 1, truncate if necessary														
			1	2*nRC	repeat Sub-Loop 0, use BA[2:0] = 1 instead													
		2	4*nRC	repeat Sub-Loop 0, use BA[2:0] = 2 instead														
		3	6*nRC	repeat Sub-Loop 0, use BA[2:0] = 3 instead														
		4	8*nRC	repeat Sub-Loop 0, use BA[2:0] = 4 instead														
		5	10*nRC	repeat Sub-Loop 0, use BA[2:0] = 5 instead														
		6	12*nRC	repeat Sub-Loop 0, use BA[2:0] = 6 instead														
7	14*nRC	repeat Sub-Loop 0, use BA[2:0] = 7 instead																

Note :

- DM must be driven LOW all the time. DQS,  $\overline{\text{DQS}}$  are MID-LEVEL.
- DQ signals are MID-LEVEL.



[ Table 33 ] IDD1 Measurement - Loop Pattern<sup>1</sup>

CK/CKE	Sub-Loop	Cycle Number	Command	CS	RAS	CAS	WE	ODT	BA[2:0]	A[15:11]	A[10]	A[9:7]	A[6:3]	A[2:0]	Data <sup>2)</sup>	
toggling	Static High	0	ACT	0	0	1	1	0	0	00	0	0	0	0	-	
		1,2	D, D	1	0	0	0	0	0	0	00	0	0	0	0	-
		3,4	D, D	1	1	1	1	0	0	0	00	0	0	0	0	-
		...	repeat pattern 1...4 until nRCD- 1, truncate if necessary													
		nRCD	RD	0	1	0	1	0	0	0	00	0	0	0	0	00000000
		...	repeat pattern 1...4 until nRAS - 1, truncate if necessary													
		nRAS	PRE	0	0	1	0	0	0	0	00	0	0	0	0	-
		...	repeat pattern 1...4 until nRC - 1, truncate if necessary													
		1*nRC+0	ACT	0	0	1	1	0	0	00	0	0	F	0	-	
		1*nRC + 1, 2	D, D	1	0	0	0	0	0	0	00	0	0	F	0	-
		1*nRC + 3, 4	D, D	1	1	1	1	0	0	00	0	0	F	0	-	
		...	repeat pattern nRC + 1,..., 4 until nRC + nRCD - 1, truncate if necessary													
		1*nRC + nRCD	RD	0	1	0	1	0	0	0	00	0	0	F	0	00110011
		...	repeat pattern nRC + 1,..., 4 until nRC + nRAS - 1, truncate if necessary													
	1*nRC + nRAS	PRE	0	0	1	0	0	0	0	00	0	0	F	0	-	
	...	repeat pattern nRC + 1,..., 4 until 2 * nRC - 1, truncate if necessary														
	1	2*nRC	repeat Sub-Loop 0, use BA[2:0] = 1 instead													
	2	4*nRC	repeat Sub-Loop 0, use BA[2:0] = 2 instead													
	3	6*nRC	repeat Sub-Loop 0, use BA[2:0] = 3 instead													
	4	8*nRC	repeat Sub-Loop 0, use BA[2:0] = 4 instead													
5	10*nRC	repeat Sub-Loop 0, use BA[2:0] = 5 instead														
6	12*nRC	repeat Sub-Loop 0, use BA[2:0] = 6 instead														
7	14*nRC	repeat Sub-Loop 0, use BA[2:0] = 7 instead														

Note :

- DM must be driven LOW all the time. DQS,  $\overline{DQS}$  are used according to RD Commands, otherwise MID-LEVEL.
- Burst Sequence driven on each DQ signal by Read Command. Outside burst operation, DQ signals are MID-LEVEL.

[ Table 34 ] IDD2 and IDD3N Measurement - Loop Pattern<sup>1</sup>

CK/CKE	Sub-Loop	Cycle Number	Command	CS	RAS	CAS	WE	ODT	BA[2:0]	A[15:11]	A[10]	A[9:7]	A[6:3]	A[2:0]	Data <sup>2)</sup>	
toggling	Static High	0	D	1	0	0	0	0	0	00	0	0	0	0	-	
		1	D	1	0	0	0	0	0	00	0	0	0	0	-	
		2	D	1	1	1	1	0	0	00	0	0	F	0	-	
		3	D	1	1	1	1	0	0	00	0	0	F	0	-	
	1	4-7	repeat Sub-Loop 0, use BA[2:0] = 1 instead													
	2	8-11	repeat Sub-Loop 0, use BA[2:0] = 2 instead													
	3	12-15	repeat Sub-Loop 0, use BA[2:0] = 3 instead													
	4	16-19	repeat Sub-Loop 0, use BA[2:0] = 4 instead													
	5	20-23	repeat Sub-Loop 0, use BA[2:0] = 5 instead													
	6	24-27	repeat Sub-Loop 0, use BA[2:0] = 6 instead													
	7	28-31	repeat Sub-Loop 0, use BA[2:0] = 7 instead													

Note :

- DM must be driven Low all the time. DQS,  $\overline{DQS}$  are MID-LEVEL.
- DQ signals are MID-LEVEL.

[ Table 35 ] IDD2NT and IDDQ2NT Measurement - Loop Pattern<sup>1</sup>

CK/CK	CKE	Sub-Loop	Cycle Number	Command	CS	RAS	CAS	WE	ODT	BA[2:0]	A[15:11]	A[10]	A[9:7]	A[6:3]	A[2:0]	Data <sup>2)</sup>		
toggling	Static High	0	0	D	1	0	0	0	0	0	00	0	0	0	0	-		
			1	D	1	0	0	0	0	0	0	00	0	0	0	0	-	
			2	D	1	1	1	1	1	0	0	0	00	0	0	F	0	-
			3	D	1	1	1	1	1	0	0	0	00	0	0	F	0	-
		1	4-7	repeat Sub-Loop 0, but ODT = 0 and BA[2:0] = 1														
		2	8-11	repeat Sub-Loop 0, but ODT = 0 and BA[2:0] = 2														
		3	12-15	repeat Sub-Loop 0, but ODT = 0 and BA[2:0] = 3														
		4	16-19	repeat Sub-Loop 0, but ODT = 0 and BA[2:0] = 4														
		5	20-23	repeat Sub-Loop 0, but ODT = 0 and BA[2:0] = 5														
		6	24-27	repeat Sub-Loop 0, but ODT = 0 and BA[2:0] = 6														
		7	28-31	repeat Sub-Loop 0, but ODT = 0 and BA[2:0] = 7														

Note :

1. DM must be driven Low all the time. DQS,  $\overline{DQS}$  are MID-LEVEL.
2. DQ signals are MID-LEVEL.

[ Table 36 ] IDD4R and IDDQ4R Measurement - Loop Pattern<sup>1</sup>

CK/CK	CKE	Sub-Loop	Cycle Number	Command	CS	RAS	CAS	WE	ODT	BA[2:0]	A[15:11]	A[10]	A[9:7]	A[6:3]	A[2:0]	Data <sup>2)</sup>		
toggling	Static High	0	0	RD	0	1	0	1	0	0	00	0	0	0	0	0000000		
			1	D	1	0	0	0	0	0	0	00	0	0	0	0	-	
			2,3	$\overline{D}, \overline{D}$	1	1	1	1	1	0	0	0	00	0	0	0	0	-
			4	RD	0	1	0	1	1	0	0	0	00	0	0	F	0	00110011
			5	D	1	0	0	0	0	0	0	0	00	0	0	F	0	-
			6,7	$\overline{D}, \overline{D}$	1	1	1	1	1	0	0	0	00	0	0	F	0	-
		1	8-15	repeat Sub-Loop 0, but BA[2:0] = 1														
		2	16-23	repeat Sub-Loop 0, but BA[2:0] = 2														
		3	24-31	repeat Sub-Loop 0, but BA[2:0] = 3														
		4	32-39	repeat Sub-Loop 0, but BA[2:0] = 4														
		5	40-47	repeat Sub-Loop 0, but BA[2:0] = 5														
		6	48-55	repeat Sub-Loop 0, but BA[2:0] = 6														
		7	56-63	repeat Sub-Loop 0, but BA[2:0] = 7														

Note :

1. DM must be driven LOW all the time. DQS,  $\overline{DQS}$  are used according to WR Commands, otherwise MID-LEVEL.
2. Burst Sequence driven on each DQ signal by Write Command. Outside burst operation, DQ signals are MID-LEVEL.

[ Table 37 ] IDD4W Measurement - Loop Pattern<sup>1</sup>

CK/CK	CKE	Sub-Loop	Cycle Number	Command	CS	RAS	CAS	WE	ODT	BA[2:0]	A[15:11]	A[10]	A[9:7]	A[6:3]	A[2:0]	Data <sup>2)</sup>							
toggling	Static High	0	0	WR	0	1	0	0	1	0	00	0	0	0	0	00000000							
			1	D	1	0	0	0	0	1	0	00	0	0	0	0	-						
			2,3	$\overline{D}, \overline{D}$	1	1	1	1	1	1	0	00	0	0	0	0	-						
			4	WR	0	1	0	0	0	1	0	00	0	0	F	0	00110011						
		1	2	3	4	5	6	7	5	D	1	0	0	0	0	0	F	0	-				
									6,7	$\overline{D}, \overline{D}$	1	1	1	1	1	1	0	00	0	0	F	0	-
									repeat Sub-Loop 0, but BA[2:0] = 1														
		repeat Sub-Loop 0, but BA[2:0] = 2																					
		repeat Sub-Loop 0, but BA[2:0] = 3																					
		repeat Sub-Loop 0, but BA[2:0] = 4																					
		repeat Sub-Loop 0, but BA[2:0] = 5																					
		repeat Sub-Loop 0, but BA[2:0] = 6																					
		repeat Sub-Loop 0, but BA[2:0] = 7																					

Note :

- DM must be driven LOW all the time. DQS,  $\overline{DQS}$  are used according to WR Commands, otherwise MID-LEVEL.
- Burst Sequence driven on each DQ signal by Write Command. Outside burst operation, DQ signals are MID-LEVEL.

[ Table 38 ] IDD5B Measurement - Loop Pattern<sup>1</sup>

CK/CK	CKE	Sub-Loop	Cycle Number	Command	CS	RAS	CAS	WE	ODT	BA[2:0]	A[15:11]	A[10]	A[9:7]	A[6:3]	A[2:0]	Data <sup>2)</sup>	
toggling	Static High	1	0	REF	0	0	0	1	0	0	00	0	0	0	0	-	
			1,2	D	1	0	0	0	0	0	0	00	0	0	0	0	-
			3,4	$\overline{D}, \overline{D}$	1	1	1	1	1	0	0	00	0	0	F	0	-
			repeat cycles 1...4, but BA[2:0] = 1														
			repeat cycles 1...4, but BA[2:0] = 2														
			repeat cycles 1...4, but BA[2:0] = 3														
			repeat cycles 1...4, but BA[2:0] = 4														
			repeat cycles 1...4, but BA[2:0] = 5														
			repeat cycles 1...4, but BA[2:0] = 6														
			repeat cycles 1...4, but BA[2:0] = 7														
		2	33...nRFC - 1	repeat Sub-Loop 1, until nRFC - 1. Truncate, if necessary.													

Note :

- DM must be driven LOW all the time. DQS,  $\overline{DQS}$  are MID-LEVEL.
- DQ signals are MID-LEVEL.

[ Table 39 ] IDD7 Measurement - Loop Pattern<sup>1</sup>

CK/CK	CKE	Sub-Loop	Cycle Number	Command	CS	RAS	CAS	WE	ODT	BA[2:0]	A[15:11]	A[10]	A[9:7]	A[6:3]	A[2:0]	Data <sup>2)</sup>		
toggling	Static High	0	0	ACT	0	0	1	1	0	0	00	0	0	0	0	-		
			1	RDA	0	1	0	1	0	0	0	00	1	0	0	0	00000000	
			2	D	1	0	0	0	0	0	0	0	00	0	0	0	0	-
			...	repeat above D Command until nRRD - 1														
		1	nRRD	ACT	0	0	1	1	0	0	1	00	0	0	F	0	-	
			nRRD + 1	RDA	0	1	0	1	0	0	1	00	1	0	F	0	00110011	
			nRRD + 2	D	1	0	0	0	0	0	1	00	0	0	F	0	-	
			...	repeat above D Command until 2*nRRD-1														
		2	2 * nRRD	repeat Sub-Loop 0, but BA[2:0] = 2														
		3	3 * nRRD	repeat Sub-Loop 1, but BA[2:0] = 3														
		4	4 * nRRD	D	1	0	0	0	0	0	3	00	0	0	F	0	-	
				Assert and repeat above D Command until nFAW - 1, if necessary														
		5	nFAW	repeat Sub-Loop 0, but BA[2:0] = 4														
		6	nFAW+nRRD	repeat Sub-Loop 1, but BA[2:0] = 5														
		7	nFAW+2*nRRD	repeat Sub-Loop 0, but BA[2:0] = 6														
		8	nFAW+3*nRRD	repeat Sub-Loop 1, but BA[2:0] = 7														
		9	nFAW+4*nRRD	D	1	0	0	0	0	0	7	00	0	0	F	0	-	
				Assert and repeat above D Command until 2*nFAW - 1, if necessary														
		10	2*nFAW+0	ACT	0	0	1	1	0	0	0	00	0	0	F	0	-	
				RDA	0	1	0	1	0	0	0	00	1	0	F	0	00110011	
D	1			0	0	0	0	0	0	0	00	0	0	F	0	-		
Repeat above D Command until 2*nFAW + nRRD - 1																		
11	2*nFAW+nRRD	ACT	0	0	1	1	0	1	00	0	0	0	0	0	-			
		RDA	0	1	0	1	0	1	00	1	0	0	0	0	00000000			
		D	1	0	0	0	0	0	1	00	0	0	0	0	-			
		Repeat above D Command until 2*nFAW + 2*nRRD - 1																
12	2*nFAW+2*nRRD	repeat Sub-Loop 10, but BA[2:0] = 2																
13	2*nFAW+3*nRRD	repeat Sub-Loop 11, but BA[2:0] = 3																
14	2*nFAW+4*nRRD	D	1	0	0	0	0	0	3	00	0	0	0	0	-			
		Assert and repeat above D Command until 3*nFAW - 1, if necessary																
15	3*nFAW	repeat Sub-Loop 10, but BA[2:0] = 4																
16	3*nFAW+nRRD	repeat Sub-Loop 11, but BA[2:0] = 5																
17	3*nFAW+2*nRRD	repeat Sub-Loop 10, but BA[2:0] = 6																
18	3*nFAW+3*nRRD	repeat Sub-Loop 11, but BA[2:0] = 7																
19	3*nFAW+4*nRRD	D	1	0	0	0	0	0	7	00	0	0	0	0	-			
		Assert and repeat above D Command until 4*nFAW - 1, if necessary																

Note :

- DM must be driven LOW all the time. DQS,  $\overline{DQS}$  are used according to RD Commands, otherwise MID-LEVEL.
- Burst Sequence driven on each DQ signal by Read Command. Outside burst operation. DQ signals are MID-LEVEL.

11.0 DDP 2Gb DDR3 SDRAM E-die IDD Spec Table

[ Table 40 ] IDD Specification for DDP 2Gb DDR3 E-die

Symbol	512Mx4 (K4B2G0446E)				Unit	Notes
	DDR3-800	DDR3-1066	DDR3-1333	DDR3-1600		
	6-6-6	7-7-7	9-9-9	TBD		
IDD0	85	90	100	TBD	mA	
IDD1	100	105	115	TBD	mA	
IDD2P0(slow exit)	20	20	20	TBD	mA	
IDD2P1(fast exit)	50	50	50	TBD	mA	
IDD2N	60	60	70	TBD	mA	
IDD2NT	60	70	80	TBD	mA	
IDD2Q	50	60	70	TBD	mA	
IDD3P(fast exit)	50	50	50	TBD	mA	
IDD3N	70	75	85	TBD	mA	
IDD4R	115	130	150	TBD	mA	
IDD4W	115	135	160	TBD	mA	
IDD5B	180	180	195	TBD	mA	
IDD6	20	20	20	TBD	mA	
IDD7	200	210	260	TBD	mA	

Symbol	256Mx8 (K4B2G0846E)				Unit	Notes
	DDR3-800	DDR3-1066	DDR3-1333	DDR3-1600		
	6-6-6	7-7-7	9-9-9	TBD		
IDD0	85	90	100	TBD	mA	
IDD1	100	105	115	TBD	mA	
IDD2P0(slow exit)	20	20	20	TBD	mA	
IDD2P1(fast exit)	50	50	50	TBD	mA	
IDD2N	60	60	70	TBD	mA	
IDD2NT	60	70	80	TBD	mA	
IDD2Q	50	60	70	TBD	mA	
IDD3P(fast exit)	50	50	50	TBD	mA	
IDD3N	70	75	85	TBD	mA	
IDD4R	125	140	160	TBD	mA	
IDD4W	115	145	170	TBD	mA	
IDD5B	180	180	195	TBD	mA	
IDD6	20	20	20	TBD	mA	
IDD7	200	215	265	TBD	mA	

## 12.0 Input/Output Capacitance

[ Table 41 ] Input/Output Capacitance

Parameter	Symbol	DDR3-800		DDR3-1066		DDR3-1333		DDR3-1600		Units	Notes
		Min	Max	Min	Max	Min	Max	Min	Max		
Input/output capacitance (DQ, DM, DQS, $\overline{DQS}$ , TDQS, $\overline{TDQS}$ )	CIO	TBD	TBD	TBD	TBD	TBD	TBD	TBD	TBD	pF	1,2,3
Input capacitance (CK and $\overline{CK}$ )	CCK	TBD	TBD	TBD	TBD	TBD	TBD	TBD	TBD	pF	2,3
Input capacitance delta (CK and $\overline{CK}$ )	CDCK	TBD	TBD	TBD	TBD	TBD	TBD	TBD	TBD	pF	2,3,4
Input capacitance (All other input-only pins)	CI	TBD	TBD	TBD	TBD	TBD	TBD	TBD	TBD	pF	2,3,6
Input capacitance delta (DQS and $\overline{DQS}$ )	CDDQS	TBD	TBD	TBD	TBD	TBD	TBD	TBD	TBD	pF	2,3,5
Input capacitance delta (All control input-only pins)	CDI_CTRL	TBD	TBD	TBD	TBD	TBD	TBD	TBD	TBD	pF	2,3,7,8
Input capacitance delta (all ADD and CMD input-only pins)	CDI_ADD_CMD	TBD	TBD	TBD	TBD	TBD	TBD	TBD	TBD	pF	2,3,9,10
Input/output capacitance delta (DQ, DM, DQS, $\overline{DQS}$ , TDQS, $\overline{TDQS}$ )	CDIO	TBD	TBD	TBD	TBD	TBD	TBD	TBD	TBD	pF	2,3,11
Input/output capacitance of ZQ pin	CZQ	TBD	TBD	TBD	TBD	TBD	TBD	TBD	TBD	pF	2, 3, 12

Note :

- Although the DM, TDQS and  $\overline{TDQS}$  pins have different functions, the loading matches DQ and DQS
- This parameter is not subject to production test. It is verified by design and characterization.  
The capacitance is measured according to JEP147("PROCEDURE FOR MEASURING INPUT CAPACITANCE USING A VECTOR NETWORK ANALYZER( VNA)") with  $V_{DD}$ ,  $V_{DDQ}$ ,  $V_{SS}$ ,  $V_{SSQ}$  applied and all other pins floating (except the pin under test, CKE,  $\overline{RESET}$  and ODT as necessary).  
 $V_{DD}=V_{DDQ}=1.5V$ ,  $V_{BIAS}=V_{DD}/2$  and on-die termination off.
- This parameter applies to monolithic devices only; stacked/dual-die devices are not covered here
- Absolute value of CCK- $\overline{CCK}$
- Absolute value of CIO(DQS)-CIO( $\overline{DQS}$ )
- CI applies to ODT,  $\overline{CS}$ , CKE, A0-A15, BA0-BA2,  $\overline{RAS}$ ,  $\overline{CAS}$ ,  $\overline{WE}$ .
- CDI\_CTRL applies to ODT,  $\overline{CS}$  and CKE
- $CDI\_CTRL=CI(CTRL)-0.5*(CI(CLK)+CI(\overline{CLK}))$
- CDI\_ADD\_CMD applies to A0-A15, BA0-BA2,  $\overline{RAS}$ ,  $\overline{CAS}$  and  $\overline{WE}$
- $CDI\_ADD\_CMD=CI(ADD\_CMD) - 0.5*(CI(CLK)+CI(\overline{CLK}))$
- $CDIO=CIO(DQ,DM) - 0.5*(CIO(DQS)+CIO(\overline{DQS}))$
- Maximum external load capacitance on ZQ pin: 5pF

## 13.0 Electrical Characteristics and AC timing for DDR3-800 to DDR3-1600

### 13.1 Clock specification

The jitter specified is a random jitter meeting a Gaussian distribution. Input clocks violating the min/max values may result in malfunction of the DDR3 SDRAM device.

#### 13.1.1 Definition for tCK (avg)

tCK(avg) is calculated as the average clock period across any consecutive 200 cycle window, where each clock period is calculated from rising edge to rising edge.

$$\left( \sum_{j=1}^N tCK_j \right) / N \quad N=200$$

#### 13.1.2 Definition for tCK (abs)

tCK(abs) is the absolute clock period, as measured from one rising edge to the next consecutive rising edge. tCK(abs) is not subject to production test.

#### 13.1.3 Definition for tCH(avg) and tCL(avg)

tCH(avg) is defined as the average high pulse width, as calculated across any consecutive 200 high pulses:

tCL(avg) is defined as the average low pulse width, as calculated across any consecutive 200 low pulses:

$$\left( \sum_{j=1}^N tCH_j \right) / N \times tCK(avg) \quad N=200 \quad \left( \sum_{j=1}^N tCL_j \right) / N \times tCK(avg) \quad N=200$$

#### 13.1.4 Definition for note for tJIT(per), tJIT(per,lck)

tJIT(per) is defined as the largest deviation of any single tCK from tCK(avg). tJIT(per) = min/max of {tCKi-tCK(avg) where i=1 to 200}

tJIT(per) defines the single period jitter when the DLL is already locked.

tJIT(per,lck) uses the same definition for single period jitter, during the DLL locking period only.

tJIT(per) and tJIT(per,lck) are not subject to production test.

#### 13.1.5 Definition for note for tJIT(cc), tJIT(cc,lck)

tJIT(cc) is defined as the absolute difference in clock period between two consecutive clock cycles: tJIT(cc) = Max of {tCKi+1-tCKi}

tJIT(cc) defines the cycle to cycle jitter when the DLL is already locked.

tJIT(cc,lck) uses the same definition for cycle to cycle jitter, during the DLL locking period only.

tJIT(cc) and tJIT(cc,lck) are not subject to production test.

#### 13.1.6 Definition for tERR(nper)

tERR is defined as the cumulative error across n multiple consecutive cycles from tCK(avg). tERR is not subject to production test.

**13.2 Refresh Parameters by Device Density**

[ Table 42 ] Refresh parameters by device density

Parameter	Symbol	1Gb	2Gb	4Gb	8Gb	Units	Note	
All Bank Refresh to active/refresh cmd time	tRFC	110	160	300	350	ns		
Average periodic refresh interval	tREFI	0 °C ≤ T <sub>CASE</sub> ≤ 85°C	7.8	7.8	7.8	7.8	μs	
		85 °C < T <sub>CASE</sub> ≤ 95°C	3.9	3.9	3.9	3.9	μs	1

Note :

1. Users should refer to the DRAM supplier data sheet and/or the DIMM SPD to determine if DDR3 SDRAM devices support the following options or requirements referred to in this material.

**13.3 Speed Bins and CL, tRCD, tRP, tRC and tRAS for corresponding Bin**

DDR3 SDRAM Speed Bins include tCK, tRCD, tRP, tRAS and tRC for each corresponding bin.

[ Table 43 ] DDR3-800 Speed Bins

Speed		DDR3-800		Units	Note
CL-nRCD-nRP		6 - 6 - 6			
Parameter	Symbol	min	max		
Internal read command to first data	tAA	15	20	ns	
ACT to internal read or write delay time	tRCD	15	-	ns	
PRE command period	tRP	15	-	ns	
ACT to ACT or REF command period	tRC	52.5	-	ns	
ACT to PRE command period	tRAS	37.5	9*tREFI	ns	8
CL = 6 / CWL = 5	tCK(AVG)	2.5	3.3	ns	1,2,3
Supported CL Settings		6		nCK	
Supported CWL Settings		5		nCK	

[ Table 44 ] DDR3-1066 Speed Bins

Speed		DDR3-1066		Units	Note	
CL-nRCD-nRP		7 - 7 - 7				
Parameter	Symbol	min	max			
Internal read command to first data	tAA	13.125	20	ns		
ACT to internal read or write delay time	tRCD	13.125	-	ns		
PRE command period	tRP	13.125	-	ns		
ACT to ACT or REF command period	tRC	50.625	-	ns		
ACT to PRE command period	tRAS	37.5	9*tREFI	ns	8	
CL = 6	CWL = 5	tCK(AVG)	2.5	3.3	ns	1,2,3,6
	CWL = 6	tCK(AVG)	Reserved		ns	1,2,3,4
CL = 7	CWL = 5	tCK(AVG)	Reserved		ns	4
	CWL = 6	tCK(AVG)	1.875	<2.5	ns	1,2,3,4
CL = 8	CWL = 5	tCK(AVG)	Reserved		ns	4
	CWL = 6	tCK(AVG)	1.875	<2.5	ns	1,2,3
Supported CL Settings		6,7,8		nCK		
Supported CWL Settings		5,6		nCK		



[ Table 45 ] DDR3-1333 Speed Bins

Speed		DDR3-1333		Units	Note
CL-nRCD-nRP		9 - 9 - 9			
Parameter	Symbol	min	max		
Internal read command to first data	tAA	13.5 (13.125) <sup>5,9</sup>	20	ns	
ACT to internal read or write delay time	tRCD	13.5 (13.125) <sup>5,9</sup>	-	ns	
PRE command period	tRP	13.5 (13.125) <sup>5,9</sup>	-	ns	
ACT to ACT or REF command period	tRC	49.5 (49.125) <sup>5,9</sup>	-	ns	
ACT to PRE command period	tRAS	36	9*tREFI	ns	8
CL = 6	CWL = 5	tCK(AVG)	2.5      3.3	ns	1,2,3,7
	CWL = 6	tCK(AVG)	Reserved	ns	1,2,3,4,7
	CWL = 7	tCK(AVG)	Reserved	ns	4
CL = 7	CWL = 5	tCK(AVG)	Reserved	ns	4
	CWL = 6	tCK(AVG)	1.875      <2.5	ns	1,2,3,4,7
			(Optional) Note 5,9		
CWL = 7	tCK(AVG)	Reserved	ns	1,2,3,4,	
CL = 8	CWL = 5	tCK(AVG)	Reserved	ns	4
	CWL = 6	tCK(AVG)	1.875      <2.5	ns	1,2,3,7
	CWL = 7	tCK(AVG)	Reserved	ns	1,2,3,4,
CL = 9	CWL = 5,6	tCK(AVG)	Reserved	ns	4
	CWL = 7	tCK(AVG)	1.5      <1.875	ns	1,2,3,4
CL = 10	CWL = 5,6	tCK(AVG)	Reserved	ns	4
	CWL = 7	tCK(AVG)	1.5      <1.875	ns	1,2,3
			(Optional)		
Supported CL Settings		6,7,8,9		nCK	
Supported CWL Settings		5,6,7		nCK	

[ Table 46 ] DDR3-1600 Speed Bins

Speed		DDR3-1600		Units	Note
CL-nRCD-nRP		11-11-11			
Parameter	Symbol	min	max		
Internal read command to first data	tAA	13.75 (13.125) <sup>5,9</sup>	20	ns	
ACT to internal read or write delay time	tRCD	13.75 (13.125) <sup>5,9</sup>	-	ns	
PRE command period	tRP	13.75 (13.125) <sup>5,9</sup>	-	ns	
ACT to ACT or REF command period	tRC	48.75 (48.125) <sup>5,9</sup>	-	ns	
ACT to PRE command period	tRAS	35	9*tREFI	ns	
CL = 6	CWL = 5	tCK(AVG)	2.5      3.3	ns	1,2,3,8
	CWL = 6	tCK(AVG)	Reserved	ns	1,2,3,4,8
	CWL = 7, 8	tCK(AVG)	Reserved	ns	4
CL = 7	CWL = 5	tCK(AVG)	Reserved	ns	4
	CWL = 6	tCK(AVG)	1.875      <2.5	ns	1,2,3,4,8
			(Optional) Note 5,9		
	CWL = 7	tCK(AVG)	Reserved	ns	1,2,3,4,8
CWL = 8	tCK(AVG)	Reserved	ns	4	
CL = 8	CWL = 5	tCK(AVG)	Reserved	ns	4
	CWL = 6	tCK(AVG)	1.875      <2.5	ns	1,2,3,8
			Reserved		
	CWL = 7	tCK(AVG)	Reserved	ns	1,2,3,4,8
CWL = 8	tCK(AVG)	Reserved	ns	1,2,3,4	
CL = 9	CWL = 5,6	tCK(AVG)	Reserved	ns	4
	CWL = 7	tCK(AVG)	1.5      <1.875	ns	1,2,3,4,8
			(Optional) Note 9,10		
CWL = 8	tCK(AVG)	TBD	ns	1,2,3,4	
CL = 10	CWL = 5,6	tCK(AVG)	Reserved	ns	4
	CWL = 7	tCK(AVG)	1.5      <1.875	ns	1,2,3,8
			(Optional) Note 9,10		
CWL = 8	tCK(AVG)	Reserved	ns	1,2,3,4	
CL = 11	CWL = 5,6,7	tCK(AVG)	Reserved	ns	4
	CWL = 8	tCK(AVG)	1.25      <1.5	ns	1,2,3,5
Supported CL Settings		6,7,8,9,10,11		nCK	
Supported CWL Settings		5,6,7,8		nCK	

**13.3.1 Speed Bin Table Notes**

Absolute Specification ( $T_{OPER}$ ;  $V_{DDQ} = V_{DD} = 1.5V \pm 0.075V$ );

Note :

1. The CL setting and CWL setting result in tCK(AVG).MIN and tCK(AVG).MAX requirements. When making a selection of tCK(AVG), both need to be fulfilled: Requirements from CL setting as well as requirements from CWL setting.
2. tCK(AVG).MIN limits: Since CAS Latency is not purely analog - data and strobe output are synchronized by the DLL - all possible intermediate frequencies may not be guaranteed. An application should use the next smaller JEDEC standard tCK(AVG) value (2.5, 1.875, 1.5, or 1.25 ns) when calculating  $CL [nCK] = tAA [ns] / tCK(AVG) [ns]$ , rounding up to the next "SupportedCL".
3. tCK(AVG).MAX limits: Calculate  $tCK(AVG) = tAA.MAX / CL \text{ SELECTED}$  and round the resulting tCK(AVG) down to the next valid speed bin (i.e. 3.3ns or 2.5ns or 1.875 ns or 1.25 ns). This result is tCK(AVG).MAX corresponding to CL SELECTED.
4. "Reserved" settings are not allowed. User must program a different value.
5. "Optional" settings allow certain devices in the industry to support this setting, however, it is not a mandatory feature. Refer to supplier's data sheet and/or the DIMM SPD information if and how this setting is supported.
6. Any DDR3-1066 speed bin also supports functional operation at lower frequencies as shown in the table which are not subject to Production Tests but verified by Design/Characterization.
7. Any DDR3-1333 speed bin also supports functional operation at lower frequencies as shown in the table which are not subject to Production Tests but verified by Design/Characterization.
8. Any DDR3-1600 speed bin also supports functional operation at lower frequencies as shown in the table which are not subject to Production Tests but verified by Design/Characterization.
9. For devices supporting optional downshift to CL=7 and CL=9, tAA/tRCD/tRP min must be 13.125 ns or lower. SPD settings must be programmed to match. For example, DDR3-1333(CL9) devices supporting downshift to DDR3-1066(CL7) should program 13.125 ns in SPD bytes for tAAmin (Byte 16), tRCDmin (Byte 18), and tRPmin (Byte 20). DDR3-1600(CL11) devices supporting downshift to DDR3-1333(CL9) or DDR3-1066(CL7) should program 13.125 ns in SPD bytes for tAAmin (Byte16), tRCDmin (Byte 18), and tRPmin (Byte 20). Once tRP (Byte 20) is programmed to 13.125ns, tRCmin (Byte 21,23) also should be programmed accordingly. For example, 49.125ns (tRASmin + tRPmin=36ns+13.125ns) for DDR3-1333(CL9) and 48.125ns (tRASmin+tRPmin=35ns+13.125ns) for DDR3-1600(CL11).

14.0 Timing Parameters by Speed Grade

[ Table 47 ] Timing Parameters by Speed Bin

Speed		DDR3-800		DDR3-1066		DDR3-1333		DDR3-1600		Units	Note
Parameter	Symbol	MIN	MAX	MIN	MAX	MIN	MAX	MIN	MAX		
<b>Clock Timing</b>											
Minimum Clock Cycle Time (DLL off mode)	tCK(DLL_OF F)	8	-	8	-	8	-	8	-	ns	6
Average Clock Period	tCK(avg)	See Speed Bins Table								ps	
Clock Period	tCK(abs)	tCK(avg)min + tJIT(per)min	tCK(avg)max + tJIT(per)max	tCK(avg)min + tJIT(per)min	tCK(avg)max + tJIT(per)max	tCK(avg)min + tJIT(per)min	tCK(avg)max + tJIT(per)max	tCK(avg)min + tJIT(per)min	tCK(avg)max + tJIT(per)max	ps	
Average high pulse width	tCH(avg)	0.47	0.53	0.47	0.53	0.47	0.53	0.47	0.53	tCK(avg)	
Average low pulse width	tCL(avg)	0.47	0.53	0.47	0.53	0.47	0.53	0.47	0.53	tCK(avg)	
Clock Period Jitter	tJIT(per)	-100	100	-90	90	-80	80	-70	70	ps	
Clock Period Jitter during DLL locking period	tJIT(per, lck)	-90	90	-80	80	-70	70	-60	60	ps	
Cycle to Cycle Period Jitter	tJIT(cc)	200		180		160		140		ps	
Cycle to Cycle Period Jitter during DLL locking period	tJIT(cc, lck)	180		160		140		120		ps	
Cumulative error across 2 cycles	tERR(2per)	-147	147	-132	132	-118	118	-103	103	ps	
Cumulative error across 3 cycles	tERR(3per)	-175	175	-157	157	-140	140	-122	122	ps	
Cumulative error across 4 cycles	tERR(4per)	-194	194	-175	175	-155	155	-136	136	ps	
Cumulative error across 5 cycles	tERR(5per)	-209	209	-188	188	-168	168	-147	147	ps	
Cumulative error across 6 cycles	tERR(6per)	-222	222	-200	200	-177	177	-155	155	ps	
Cumulative error across 7 cycles	tERR(7per)	-232	232	-209	209	-186	186	-163	163	ps	
Cumulative error across 8 cycles	tERR(8per)	-241	241	-217	217	-193	193	-169	169	ps	
Cumulative error across 9 cycles	tERR(9per)	-249	249	-224	224	-200	200	-175	175	ps	
Cumulative error across 10 cycles	tERR(10per)	-257	257	-231	231	-205	205	-180	180	ps	
Cumulative error across 11 cycles	tERR(11per)	-263	263	-237	237	-210	210	-184	184	ps	
Cumulative error across 12 cycles	tERR(12per)	-269	269	-242	242	-215	215	-188	188	ps	
Cumulative error across n = 13, 14 ... 49, 50 cycles	tERR(nper)	tERR(nper)min = (1 + 0.68ln(n))*tJIT(per)min tERR(nper)max = (1 + 0.68ln(n))*tJIT(per)max								ps	24
Absolute clock HIGH pulse width	tCH(abs)	0.43	-	0.43	-	0.43	-	0.43	-	tCK(avg)	25
Absolute clock Low pulse width	tCL(abs)	0.43	-	0.43	-	0.43	-	0.43	-	tCK(avg)	26
<b>Data Timing</b>											
DQS, $\overline{DQS}$ to DQ skew, per group, per access	tDQSQ	-	200	-	150	-	125	-	100	ps	13
DQ output hold time from DQS, $\overline{DQS}$	tQH	0.38	-	0.38	-	0.38	-	0.38	-	tCK(avg)	13, g
DQ low-impedance time from CK, $\overline{CK}$	tLZ(DQ)	-800	400	-600	300	-500	250	-450	225	ps	13,14, f
DQ high-impedance time from CK, $\overline{CK}$	tHZ(DQ)	-	400	-	300	-	250	-	225	ps	13,14, f
Data setup time to DQS, $\overline{DQS}$ referenced to $V_{IH}(AC)V_{IL}(AC)$ levels	tDS(base)	75	-	25	-	30	-	10	-	ps	d, 17
Data hold time to DQS, $\overline{DQS}$ referenced to $V_{IH}(AC)V_{IL}(AC)$ levels	tDH(base)	150	-	100	-	65	-	45	-	ps	d, 17
DQ and DM Input pulse width for each input	tDIPW	600	-	490	-	400	-	360	-	ps	28
<b>Data Strobe Timing</b>											
DQS, $\overline{DQS}$ READ Preamble	tRPRE	0.9	Note 19	0.9	Note 19	0.9	Note 19	0.9	Note 19	tCK	13, 19, g
DQS, $\overline{DQS}$ differential READ Postamble	tRPST	0.3	Note 11	0.3	Note 11	0.3	Note 11	0.3	Note 11	tCK	11, 13, b
DQS, $\overline{DQS}$ output high time	tQSH	0.38	-	0.38	-	0.4	-	0.4	-	tCK(avg)	13, g
DQS, $\overline{DQS}$ output low time	tQSL	0.38	-	0.38	-	0.4	-	0.4	-	tCK(avg)	13, g
DQS, $\overline{DQS}$ WRITE Preamble	tWPRE	0.9	-	0.9	-	0.9	-	0.9	-	tCK	
DQS, $\overline{DQS}$ WRITE Postamble	tWPST	0.3	-	0.3	-	0.3	-	0.3	-	tCK	
DQS, $\overline{DQS}$ rising edge output access time from rising CK, $\overline{CK}$	tDQSCK	-400	400	-300	300	-255	255	-225	225	ps	13, f
DQS, $\overline{DQS}$ low-impedance time (Referenced from RL-1)	tLZ(DQS)	-800	400	-600	300	-500	250	-450	225	ps	13,14, f
DQS, $\overline{DQS}$ high-impedance time (Referenced from RL+BL/2)	tHZ(DQS)	-	400	-	300	-	250	-	225	ps	12,13,14
DQS, $\overline{DQS}$ differential input low pulse width	tDQSL	0.45	0.55	0.45	0.55	0.45	0.55	0.45	0.55	tCK	29, 31
DQS, $\overline{DQS}$ differential input high pulse width	tDQSH	0.45	0.55	0.45	0.55	0.45	0.55	0.45	0.55	tCK	30, 31
DQS, $\overline{DQS}$ rising edge to CK, $\overline{CK}$ rising edge	tDQSS	-0.25	0.25	-0.25	0.25	-0.25	0.25	-0.27	0.27	tCK(avg)	c
DQS, $\overline{DQS}$ falling edge setup time to CK, $\overline{CK}$ rising edge	tDSS	0.2	-	0.2	-	0.2	-	0.18	-	tCK(avg)	c, 32
DQS, $\overline{DQS}$ falling edge hold time to CK, $\overline{CK}$ rising edge	tDSH	0.2	-	0.2	-	0.2	-	0.18	-	tCK(avg)	c, 32

[ Tabel 47 ] Timing Parameters by Speed Bin (Cont.)

Speed		DDR3-800		DDR3-1066		DDR3-1333		DDR3-1600		Units	Note
Parameter	Symbol	MIN	MAX	MIN	MAX	MIN	MAX	MIN	MAX		
<b>Command and Address Timing</b>											
DLL locking time	tDLLK	512	-	512	-	512	-	512	-	nCK	
Internal READ Command to PRECHARGE Command delay	tRTP	max (4nCK, 7.5ns)	-	max (4nCK, 7.5ns)	-	max (4nCK, 7.5ns)	-	max (4nCK, 7.5ns)	-		e
Delay from start of internal write transaction to internal read command	tWTR	max (4nCK, 7.5ns)	-	max (4nCK, 7.5ns)	-	max (4nCK, 7.5ns)	-	max (4nCK, 7.5ns)	-		e, 18
WRITE recovery time	tWR	15	-	15	-	15	-	15	-	ns	e
Mode Register Set command cycle time	tMRD	4	-	4	-	4	-	4	-	nCK	
Mode Register Set command update delay	tMOD	max (12nCK, 15ns)	-	max (12nCK, 15ns)	-	max (12nCK, 15ns)	-	max (12nCK, 15ns)	-		
CAS# to CAS# command delay	tCCD	4	-	4	-	4	-	4	-	nCK	
Auto precharge write recovery + precharge time	tDAL(min)	WR + roundup (tRP / tCK(AVG))								nCK	
Multi-Purpose Register Recovery Time	tMPRR	1	-	1	-	1	-	1	-	nCK	22
ACTIVE to PRECHARGE command period	tRAS	See 13.3 " Speed Bins and CL, tRCD, tRP, tRC and tRAS for corresponding Bin" on page 37								ns	e
ACTIVE to ACTIVE command period for 1KB page size	tRRD	max (4nCK, 10ns)	-	max (4nCK, 7.5ns)	-	max (4nCK, 6ns)	-	max (4nCK, 6ns)	-		e
ACTIVE to ACTIVE command period for 2KB page size	tRRD	max (4nCK, 10ns)	-	max (4nCK, 10ns)	-	max (4nCK, 7.5ns)	-	max (4nCK, 7.5ns)	-		e
Four activate window for 1KB page size	tFAW	40	-	37.5	-	30	-	30	-	ns	e
Four activate window for 2KB page size	tFAW	50	-	50	-	45	-	40	-	ns	e
Command and Address setup time to CK, $\overline{CK}$ referenced to $V_{IH}(AC)$ / $V_{IL}(AC)$ levels	tIS(base)	200	-	125	-	65	-	TBD	-	ps	b, 16
Command and Address hold time from CK, $\overline{CK}$ referenced to $V_{IH}(AC)$ / $V_{IL}(AC)$ levels	tIH(base)	275	-	200	-	140	-	TBD	-	ps	b, 16
Command and Address setup time to CK, $\overline{CK}$ referenced to $V_{IH}(AC)$ / $V_{IL}(AC)$ levels	tIS(base) AC150	200 + 150	-	125 + 150	-	65+125	-	TBD+125	-	ps	b, 16, 27
Control & Address Input pulse width for each input	tIPW	900	-	780	-	620	-	560	-	ps	28
<b>Calibration Timing</b>											
Power-up and RESET calibration time	tZQinitl	512	-	512	-	512	-	512	-	nCK	
Normal operation Full calibration time	tZQoper	256	-	256	-	256	-	256	-	nCK	
Normal operation short calibration time	tZQCS	64	-	64	-	64	-	64	-	nCK	23
<b>Reset Timing</b>											
Exit Reset from CK HIGH to a valid command	tXPR	max(5nCK, tRFC + 10ns)	-	max(5nCK, tRFC + 10ns)	-	max(5nCK, tRFC + 10ns)	-	max(5nCK, tRFC + 10ns)	-		
<b>Self Refresh Timing</b>											
Exit Self Refresh to commands not requiring a locked DLL	tXS	max(5nCK, tRFC + 10ns)	-	max(5nCK, tRFC + 10ns)	-	max(5nCK, tRFC + 10ns)	-	max(5nCK, tRFC + 10ns)	-		
Exit Self Refresh to commands requiring a locked DLL	tXSDLL	tDLLK(min)	-	tDLLK(min)	-	tDLLK(min)	-	tDLLK(min)	-	nCK	
Minimum CKE low width for Self refresh entry to exit timing	tCKESR	tCKE(min) + 1tCK	-	tCKE(min) + 1tCK	-	tCKE(min) + 1tCK	-	tCKE(min) + 1tCK	-		
Valid Clock Requirement after Self Refresh Entry (SRE) or Power-Down Entry (PDE)	tCKSRE	max(5nCK, 10ns)	-	max(5nCK, 10ns)	-	max(5nCK, 10ns)	-	max(5nCK, 10ns)	-		
Valid Clock Requirement before Self Refresh Exit (SRX) or Power-Down Exit (PDX) or Reset Exit	tCKSRX	max(5nCK, 10ns)	-	max(5nCK, 10ns)	-	max(5nCK, 10ns)	-	max(5nCK, 10ns)	-		

[ Table 47 ] Timing Parameters by Speed Bin (Cont.)

Speed		DDR3-800		DDR3-1066		DDR3-1333		DDR3-1600		Units	Note
Parameter	Symbol	MIN	MAX	MIN	MAX	MIN	MAX	MIN	MAX		
<b>Power Down Timing</b>											
Exit Power Down with DLL on to any valid command; Exit Precharge Power Down with DLL frozen to commands not requiring a locked DLL	tXP	max (3nCK, 7.5ns)	-	max (3nCK, 7.5ns)	-	max (3nCK, 6ns)	-	max (3nCK, 6ns)	-		
Exit Precharge Power Down with DLL frozen to commands requiring a locked DLL	tXPDLL	max (10nCK, 24ns)	-	max (10nCK, 24ns)	-	max (10nCK, 24ns)	-	max (10nCK, 24ns)	-		2
CKE minimum pulse width	tCKE	max (3nCK, 7.5ns)	-	max (3nCK, 5.625ns)	-	max (3nCK, 5.625ns)	-	max (3nCK, 5ns)	-		
Command pass disable delay	tCPDED	1	-	1	-	1	-	1	-	nCK	
Power Down Entry to Exit Timing	tPD	tCKE(min)	9*tREFI	tCKE(min)	9*tREFI	tCKE(min)	9*tREFI	tCKE(min)	9*tREFI	tCK	15
Timing of ACT command to Power Down entry	tACTPDEN	1	-	1	-	1	-	1	-	nCK	20
Timing of PRE command to Power Down entry	tPRPDEN	1	-	1	-	1	-	1	-	nCK	20
Timing of RD/RDA command to Power Down entry	tRDPDEN	RL + 4 + 1	-	RL + 4 + 1	-	RL + 4 + 1	-	RL + 4 + 1	-		
Timing of WR command to Power Down entry (BL8OTF, BL8MRS, BL4OTF)	tWRPDEN	WL + 4 + (tWR/tCK)(avg)	-	WL + 4 + (tWR/tCK)(avg)	-	WL + 4 + (tWR/tCK)(avg)	-	WL + 4 + (tWR/tCK)(avg)	-	nCK	9
Timing of WRA command to Power Down entry (BL8OTF, BL8MRS, BL4OTF)	tWRAPDEN	WL + 4 + WR + 1	-	WL + 4 + WR + 1	-	WL + 4 + WR + 1	-	WL + 4 + WR + 1	-	nCK	10
Timing of WR command to Power Down entry (BL4MRS)	tWRPDEN	WL + 2 + (tWR/tCK)(avg)	-	WL + 2 + (tWR/tCK)(avg)	-	WL + 2 + (tWR/tCK)(avg)	-	WL + 2 + (tWR/tCK)(avg)	-	nCK	9
Timing of WRA command to Power Down entry (BL4MRS)	tWRAPDEN	WL + 2 + WR + 1	-	WL + 2 + WR + 1	-	WL + 2 + WR + 1	-	WL + 2 + WR + 1	-	nCK	10
Timing of REF command to Power Down entry	tREFPDEN	1	-	1	-	1	-	1	-		20,21
Timing of MRS command to Power Down entry	tMRSPDEN	tMOD(min)	-	tMOD(min)	-	tMOD(min)	-	tMOD(min)	-		
<b>ODT Timing</b>											
ODT high time without write command or with write command and BC4	ODTH4	4	-	4	-	4	-	4	-	nCK	
ODT high time with Write command and BL8	ODTH8	6	-	6	-	6	-	6	-	nCK	
Asynchronous RTT turn-on delay (Power-Down with DLL frozen)	tAONPD	2	8.5	2	8.5	2	8.5	2	8.5	ns	
Asynchronous RTT turn-off delay (Power-Down with DLL frozen)	tAOFPD	2	8.5	2	8.5	2	8.5	2	8.5	ns	
ODT turn-on	tAON	-400	400	-300	300	-250	250	-225	225	ps	7,f
RTT_NOM and RTT_WR turn-off time from ODTLoff reference	tAOF	0.3	0.7	0.3	0.7	0.3	0.7	0.3	0.7	tCK(avg)	8,f
RTT dynamic change skew	tADC	0.3	0.7	0.3	0.7	0.3	0.7	0.3	0.7	tCK(avg)	f
<b>Write Leveling Timing</b>											
First DQS pulse rising edge after tDQSS margining mode is programmed	tWLMRD	40	-	40	-	40	-	40	-	tCK	3
DQS/DQS delay after tDQSS margining mode is programmed	tWLDQSEN	25	-	25	-	25	-	25	-	tCK	3
Setup time for tDQSS latch	tWLS	325	-	245	-	195	-	165	-	ps	
Write leveling hold time from rising DQS, DQS crossing to rising CK, CK crossing	tWLH	325	-	245	-	195	-	165	-	ps	
Write leveling output delay	tWLO	0	9	0	9	0	9	0	7.5	ns	
Write leveling output error	tWLOE	0	2	0	2	0	2	0	2	ns	

## 14.1 Jitter Notes

- Specific Note a** Unit 'tCK(avg)' represents the actual tCK(avg) of the input clock under operation. Unit 'nCK' represents one clock cycle of the input clock, counting the actual clock edges.ex) tMRD = 4 [nCK] means; if one Mode Register Set command is registered at Tm, another Mode Register Set command may be registered at Tm+4, even if (Tm+4 - Tm) is 4 x tCK(avg) + tERR(4per),min.
- Specific Note b** These parameters are measured from a command/address signal ( $\overline{\text{CKE}}$ ,  $\overline{\text{CS}}$ ,  $\overline{\text{RAS}}$ ,  $\overline{\text{CAS}}$ ,  $\overline{\text{WE}}$ , ODT, BA0, A0, A1, etc.) transition edge to its respective clock signal (CK/ $\overline{\text{CK}}$ ) crossing. The spec values are not affected by the amount of clock jitter applied (i.e. tJIT(per), tJIT(cc), etc.), as the setup and hold are relative to the clock signal crossing that latches the command/address. That is, these parameters should be met whether clock jitter is present or not.
- Specific Note c** These parameters are measured from a data strobe signal (DQS(L/U),  $\overline{\text{DQS}}$ (L/U)) crossing to its respective clock signal (CK,  $\overline{\text{CK}}$ ) crossing. The spec values are not affected by the amount of clock jitter applied (i.e. tJIT(per), tJIT(cc), etc.), as these are relative to the clock signal crossing. That is, these parameters should be met whether clock jitter is present or not.
- Specific Note d** These parameters are measured from a data signal (DM(L/U), DQ(L/U)0, DQ(L/U)1, etc.) transition edge to its respective data strobe signal (DQS(L/U),  $\overline{\text{DQS}}$ (L/U)) crossing. Specific Note e For these parameters, the DDR3 SDRAM device supports tPARAM [nCK] =  $\text{RU}\{t\text{PARAM} [\text{ns}] / t\text{CK}(\text{avg}) [\text{ns}]\}$ , which is in clock cycles, assuming all input clock jitter specifications are satisfied. For example, the device will support tRP =  $\text{RU}\{t\text{RP} / t\text{CK}(\text{avg})\}$ , which is in clock cycles, if all input clock jitter specifications are met. This means: For DDR3-800 6-6-6, of which tRP = 15ns, the device will support tRP =  $\text{RU}\{t\text{RP} / t\text{CK}(\text{avg})\} = 6$ , as long as the input clock jitter specifications are met, i.e. Precharge command at Tm and Active command at Tm+6 is valid even if (Tm+6 - Tm) is less than 15ns due to input clock jitter.
- Specific Note f** When the device is operated with input clock jitter, this parameter needs to be derated by the actual tERR(mper),act of the input clock, where  $2 \leq m \leq 12$ . (output deratings are relative to the SDRAM input clock.)  
For example, if the measured jitter into a DDR3-800 SDRAM has tERR(mper),act,min = - 172 ps and tERR(mper),act,max = + 193 ps, then tDQSCK,min(derated) = tDQSCK,min - tERR(mper),act,max = - 400 ps - 193 ps = - 593 ps and tDQSCK,max(derated) = tDQSCK,max - tERR(mper),act,min = 400 ps + 172 ps = + 572 ps. Similarly, tLZ(DQ) for DDR3-800 derates to tLZ(DQ),min(derated) = - 800 ps - 193 ps = - 993 ps and tLZ(DQ),max(derated) = 400 ps + 172 ps = + 572 ps. (Caution on the min/max usage!)  
Note that tERR(mper),act,min is the minimum measured value of tERR(nper) where  $2 \leq n \leq 12$ , and tERR(mper),act,max is the maximum measured value of tERR(nper) where  $2 \leq n \leq 12$ .
- Specific Note g** When the device is operated with input clock jitter, this parameter needs to be derated by the actual tJIT(per),act of the input clock. (output deratings are relative to the SDRAM input clock.) For example, if the measured jitter into a DDR3-800 SDRAM has tCK(avg),act = 2500 ps, tJIT(per),act,min = - 72 ps and tJIT(per),act,max = + 93 ps, then tRPRE,min(derated) = tRPRE,min + tJIT(per),act,min = 0.9 x tCK(avg),act + tJIT(per),act,min = 0.9 x 2500 ps - 72 ps = + 2178 ps. Similarly, tQH,min(derated) = tQH,min + tJIT(per),act,min = 0.38 x tCK(avg),act + tJIT(per),act,min = 0.38 x 2500 ps - 72 ps = + 878 ps. (Caution on the min/max usage!)

## 14.2 Timing Parameter Notes

1. Actual value dependant upon measurement level definitions which are TBD.
2. Commands requiring a locked DLL are: READ (and RAP) and synchronous ODT commands.
3. The max values are system dependent.
4. WR as programmed in mode register
5. Value must be rounded-up to next higher integer value
6. There is no maximum cycle time limit besides the need to satisfy the refresh interval, tREFI.
7. For definition of RTT turn-on time tAON see "Device Operation"
8. For definition of RTT turn-off time tAOF see "Device Operation".
9. tWR is defined in ns, for calculation of tWRPDEN it is necessary to round up tWR / tCK to the next integer.
10. WR in clock cycles as programmed in MR0
11. The maximum read postamble is bound by tDQSQ(min) plus tQSH(min) on the left side and tHZ(DQS)max on the right side. Device Operation.
12. Output timing deratings are relative to the SDRAM input clock. When the device is operated with input clock jitter, this parameter needs to be derated by TBD
13. Value is valid for RON34
14. Single ended signal parameter. Refer to chapter 8 and chapter 9 for definition and measurement method.
15. tREFI depends on T<sub>OPER</sub>
16. tIS(base) and tIH(base) values are for 1V/ns CMD/ADD single-ended slew rate and 2V/ns CK,  $\overline{\text{CK}}$  differential slew rate, Note for DQ and DM signals, V<sub>REF(DC)</sub> = V<sub>REFDQ(DC)</sub>. For input only pins except RESET, V<sub>REF(DC)</sub>=V<sub>REFCA(DC)</sub>. See "Address/ Command Setup, Hold and Derating"
17. tDS(base) and tDH(base) values are for 1V/ns DQ single-ended slew rate and 2V/ns DQS,  $\overline{\text{DQS}}$  differential slew rate. Note for DQ and DM signals, V<sub>REF(DC)</sub>= V<sub>REFDQ(DC)</sub>. For input only pins except RESET, V<sub>REF(DC)</sub>=V<sub>REFCA(DC)</sub>. See "Data Setup, Hold and Slew Rate Derating"
18. Start of internal write transaction is defined as follows ;  
For BL8 (fixed by MRS and on-the-fly) : Rising clock edge 4 clock cycles after WL.  
For BC4 (on-the-fly) : Rising clock edge 4 clock cycles after WL  
For BC4 (fixed by MRS) : Rising clock edge 2 clock cycles after WL
19. The maximum read preamble is bound by tLZDQS(min) on the left side and tDQSQ(max) on the right side. See "Device Operation"
20. CKE is allowed to be registered low while operations such as row activation, precharge, autoprecharge or refresh are in progress, but power-down IDD spec will not be applied until finishing those operations.
21. Although CKE is allowed to be registered LOW after a REFRESH command once tREFPDEN(min) is satisfied, there are cases where additional time such as tXPDLL(min) is also required. See "Device Operation".
22. Defined between end of MPR read burst and MRS which reloads MPR or disables MPR function.
23. One ZQCS command can effectively correct a minimum of 0.5 % (ZQCorrection) of RON and RTT impedance error within 64 nCK for all speed bins assuming the maximum sensitivities specified in the 'Output Driver Voltage and Temperature Sensitivity' and 'ODT Voltage and Temperature Sensitivity' tables. The appropriate interval between ZQCS commands can be determined from these tables and other application specific parameters. One method for calculating the interval between ZQCS commands, given the temperature (Tdriftrate) and voltage (Vdriftrate) drift rates that the SDRAM is subject to in the application, is illustrated. The interval could be defined by the following formula:

$$\frac{\text{ZQCorrection}}{(\text{TSens} \times \text{Tdriftrate}) + (\text{VSens} \times \text{Vdriftrate})}$$

where TSens = max(dRTTdT, dRONdTM) and VSens = max(dRTTdV, dRONdVM) define the SDRAM temperature and voltage sensitivities.

For example, if TSens = 1.5% /°C, VSens = 0.15% / mV, Tdriftrate = 1°C / sec and Vdriftrate = 15 mV / sec, then the interval between ZQCS commands is calculated as:

$$\frac{0.5}{(1.5 \times 1) + (0.15 \times 15)} = 0.133 \approx 128\text{ms}$$

24. n = from 13 cycles to 50 cycles. This row defines 38 parameters.
25. tCH(abs) is the absolute instantaneous clock high pulse width, as measured from one rising edge to the following falling edge.
26. tCL(abs) is the absolute instantaneous clock low pulse width, as measured from one falling edge to the following rising edge.
27. The tIS(base) AC150 specifications are adjusted from the tIS(base) specification by adding an additional 100 ps of derating to accommodate for the lower alternate threshold of 150 mV and another 25 ps to account for the earlier reference point [(175 mv - 150 mV) / 1 V/ns].
28. Pulse width of a input signal is defined as the width between the first crossing of V<sub>REF(DC)</sub> and the consecutive crossing of V<sub>REF(DC)</sub>
29. tDQSL describes the instantaneous differential input low pulse width on DQS-DQS, as measured from one falling edge to the next consecutive rising edge.
30. tDQSH describes the instantaneous differential input high pulse width on DQS-DQS, as measured from one rising edge to the next consecutive falling edge.
31. tDQSH, act + tDQSL, act = 1 tCK, act ; with tXYZ, act being the actual measured value of the respective timing parameter in the application.
32. tDSH, act + tDSS, act = 1 tCK, act ; with tXYZ, act being the actual measured value of the respective timing parameter in the application.



14.3 Address / Command Setup, Hold and Derating:

For all input signals the total tIS (setup time) and tIH (hold time) required is calculated by adding the data sheet tIS(base) and tIH(base) value (see Table 48) to the ΔtIS and ΔtIH derating value (see Table 49) respectively.

Example: tIS (total setup time) = tIS(base) + ΔtIS Setup (tIS) nominal slew rate for a rising signal is defined as the slew rate between the last crossing of V<sub>REF</sub>(DC) and the first crossing of V<sub>IH</sub>(AC)min. Setup (tIS) nominal slew rate for a falling signal is defined as

the slew rate between the last crossing of V<sub>REF</sub>(DC) and the first crossing of V<sub>IL</sub>(AC)max. If the actual signal is always earlier than the nominal slew rate line between shaded 'V<sub>REF</sub>(DC) to ac region', use nominal slew rate for derating value (see Figure 23). If the actual signal is later than the nominal slew rate line anywhere between shaded 'V<sub>REF</sub>(DC) to ac region', the slew rate of a tangent line to the actual signal from the ac level to dc level is used for derating value (see Figure 25).

Hold (tIH) nominal slew rate for a rising signal is defined as the slew rate between the last crossing of V<sub>IL</sub>(DC)max and the first crossing of V<sub>REF</sub>(DC).

Hold (tIH) nominal slew rate for a falling signal is defined as the slew rate between the last crossing of V<sub>IH</sub>(DC)min and the first crossing of V<sub>REF</sub>(DC). If the actual signal is always later than the nominal slew rate line between shaded 'dc to V<sub>REF</sub>(DC) region', use nominal slew rate for derating value (see Figure 24). If the actual signal is earlier than the nominal slew rate line anywhere between shaded 'dc to V<sub>REF</sub>(DC) region', the slew rate of a tangent line to the actual signal from the dc level to V<sub>REF</sub>(DC) level is used for derating value (see Figure 26).

For a valid transition the input signal has to remain above/below V<sub>IH/IL</sub>(AC) for some time tVAC (see Table 50).

Although for slow slew rates the total setup time might be negative (i.e. a valid input signal will not have reached V<sub>IH/IL</sub>(AC) at the time of the rising clock transition) a valid input signal is still required to complete the transition and reach V<sub>IH/IL</sub>(AC).

For slew rates in between the values listed in Table 51, the derating values may obtained by linear interpolation.

These values are typically not subject to production test. They are verified by design and characterization.

[ Table 48 ] ADD/CMD Setup and Hold Base-Values for 1V/ns

[ps]	DDR3-800	DDR3-1066	DDR3-1333	DDR3-1600	reference
tIS(base)	200	125	65	45	V <sub>IH/IL</sub> (AC)
tIH(base)	275	200	140	120	V <sub>IH/IL</sub> (DC)
tIS(base)-AC150	200 + 150	125 + 150	65+125	45+125	V <sub>IH/IL</sub> (AC)

Note : AC/DC referenced for 1V/ns DQ-slew rate and 2V/ns DQS slew rate

Note : The tIS(base)-AC150 specifications are further adjusted to add an additional 100ps of derating to accommodate for the lower alternate threshold of 150mV and another 25ps to account for the earlier reference point [(175mv-150mV)/1 V/ns].

[ Table 49 ] Derating values DDR3-800/1066/1333/1600 tIS/tIH-ac/dc based

ΔtIS, ΔtIH Derating [ps] AC/DC based AC175 Threshold -> V <sub>IH</sub> (AC) = V <sub>REF</sub> (DC) + 175mV, V <sub>IL</sub> (AC) = V <sub>REF</sub> (DC) - 175mV																	
		CLK,CLK Differential Slew Rate															
		4.0 V/ns		3.0 V/ns		2.0 V/ns		1.8 V/ns		1.6 V/ns		1.4V/ns		1.2V/ns		1.0V/ns	
		ΔtIS	ΔtIH	ΔtIS	ΔtIH	ΔtIS	ΔtIH	ΔtIS	ΔtIH	ΔtIS	ΔtIH	ΔtIS	ΔtIH	ΔtIS	ΔtIH	ΔtIS	ΔtIH
CMD/ ADD Slew rate V/ns	2.0	88	50	88	50	88	50	96	58	104	66	112	74	120	84	128	100
	1.5	59	34	59	34	59	34	67	42	75	50	83	58	91	68	99	84
	1.0	0	0	0	0	0	0	8	8	16	16	24	24	32	34	40	50
	0.9	-2	-4	-2	-4	-2	-4	6	4	14	12	20	20	30	30	38	46
	0.8	-6	-10	-6	-10	-6	-10	2	-2	10	6	13	14	26	24	34	40
	0.7	-11	-16	-11	-16	-11	-16	-3	-8	5	0	13	8	21	18	29	34
	0.6	-17	-26	-17	-26	-17	-26	-9	-18	-1	-10	7	-2	15	8	23	24
	0.5	-35	-40	-35	-40	-35	-40	-27	-32	-19	-24	-11	-16	-2	-6	5	10
0.4	-62	-60	-62	-60	-62	-60	-54	-52	-46	-44	-38	-36	-30	-26	-22	-10	

[ Table 50 ] Derating values DDR3-1333/1600 tIS/tIH-ac/dc based - Alternate AC150 Threshold

$\Delta tIS, \Delta tIH$ Derating [ps] AC/DC based Alternate AC150 Threshold $\rightarrow V_{IH}(AC) = V_{REF}(DC) + 150mV, V_{IL}(AC) = V_{REF}(DC) - 150mV$																	
		CLK,CLK Differential Slew Rate															
		4.0 V/ns		3.0 V/ns		2.0 V/ns		1.8 V/ns		1.6 V/ns		1.4V/ns		1.2V/ns		1.0V/ns	
		$\Delta tIS$	$\Delta tIH$	$\Delta tIS$	$\Delta tIH$	$\Delta tIS$	$\Delta tIH$	$\Delta tIS$	$\Delta tIH$	$\Delta tIS$	$\Delta tIH$	$\Delta tIS$	$\Delta tIH$	$\Delta tIS$	$\Delta tIH$	$\Delta tIS$	$\Delta tIH$
CMD/ ADD Slew rate V/ns	2.0	75	50	75	50	75	50	83	58	91	66	99	74	107	84	115	100
	1.5	50	34	50	34	50	34	58	42	66	50	74	58	82	68	90	84
	1.0	0	0	0	0	0	0	8	8	16	16	24	24	32	34	40	50
	0.9	0	-4	0	-4	0	-4	8	4	16	12	24	20	32	30	40	46
	0.8	0	-10	0	-10	0	-10	8	-2	16	6	24	14	32	24	40	40
	0.7	0	-16	0	-16	0	-16	8	-8	16	0	24	8	32	18	40	34
	0.6	-1	-26	-1	-26	-1	-26	7	-18	15	-10	23	-2	31	8	39	24
	0.5	-10	-40	-10	-40	-10	-40	-2	-32	6	-24	14	-16	22	-6	30	10
	0.4	-25	-60	-25	-60	-25	-60	-17	-52	-9	-44	-1	-36	7	-26	15	-10

[ Table 51 ] Required time  $t_{VAC}$  above  $V_{IH}(AC)$  {blow  $V_{IL}(AC)$ } for valid transition

Slew Rate[V/ns]	$t_{VAC}$ @175mV [ps]		$t_{VAC}$ @150mV [ps]	
	min	max	min	max
>2.0	75	-	175	-
2.0	57	-	170	-
1.5	50	-	167	-
1.0	38	-	163	-
0.9	34	-	162	-
0.8	29	-	161	-
0.7	22	-	159	-
0.6	13	-	155	-
0.5	0	-	150	-
< 0.5	0	-	150	-

Note :Clock and Strobe are drawn on a different time scale.

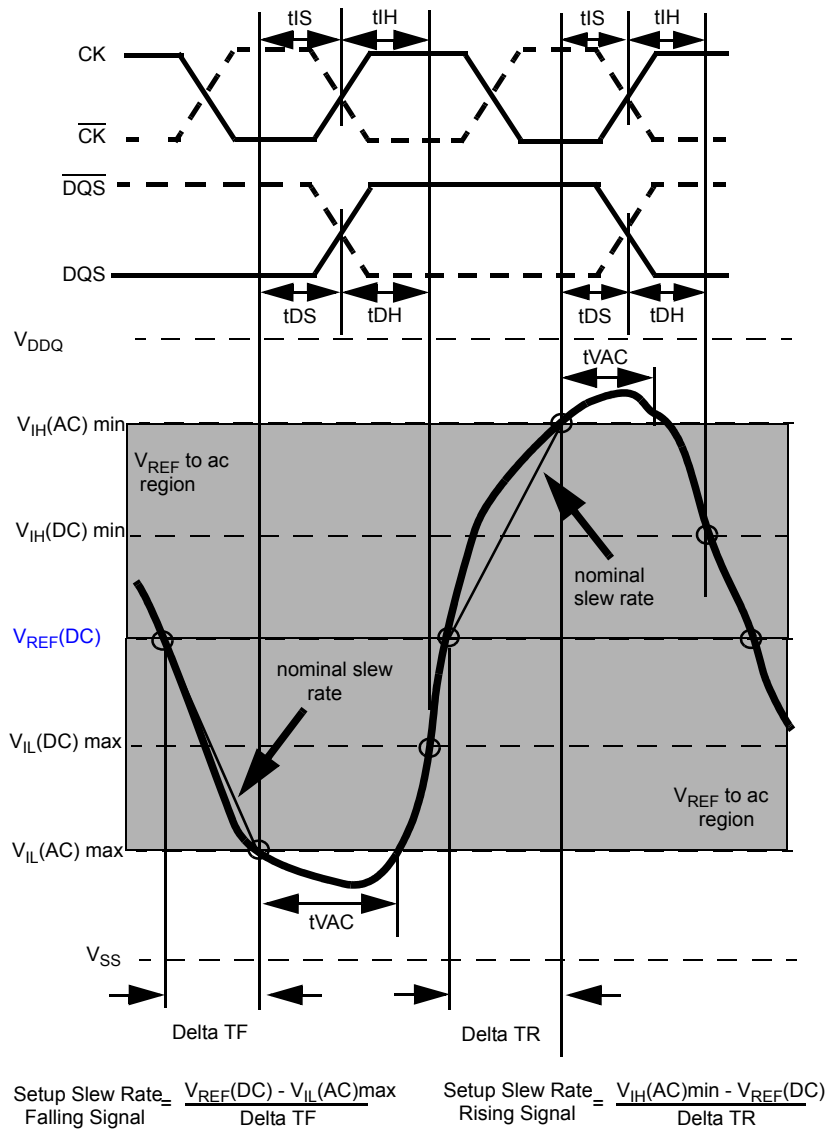

Figure 21 - Illustration of nominal slew rate and tVAC for setup time tDS (for DQ with respect to strobe) and tIS (for ADD/CMD with respect to clock).

Note :Clock and Strobe are drawn on a different time scale.

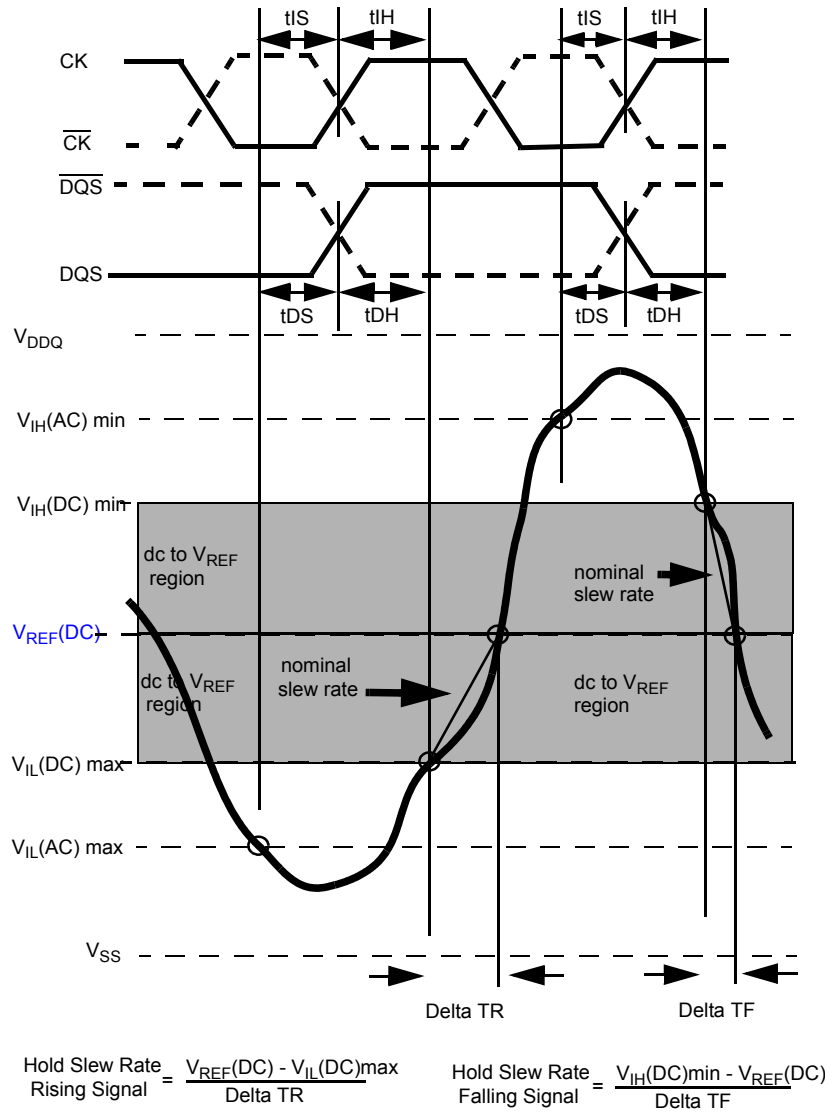

Figure 22 - Illustration of nominal slew rate for hold time tDH (for DQ with respect to strobe) and tIH (for ADD/CMD with respect to clock).

Note :Clock and Strobe are drawn on a different time scale.

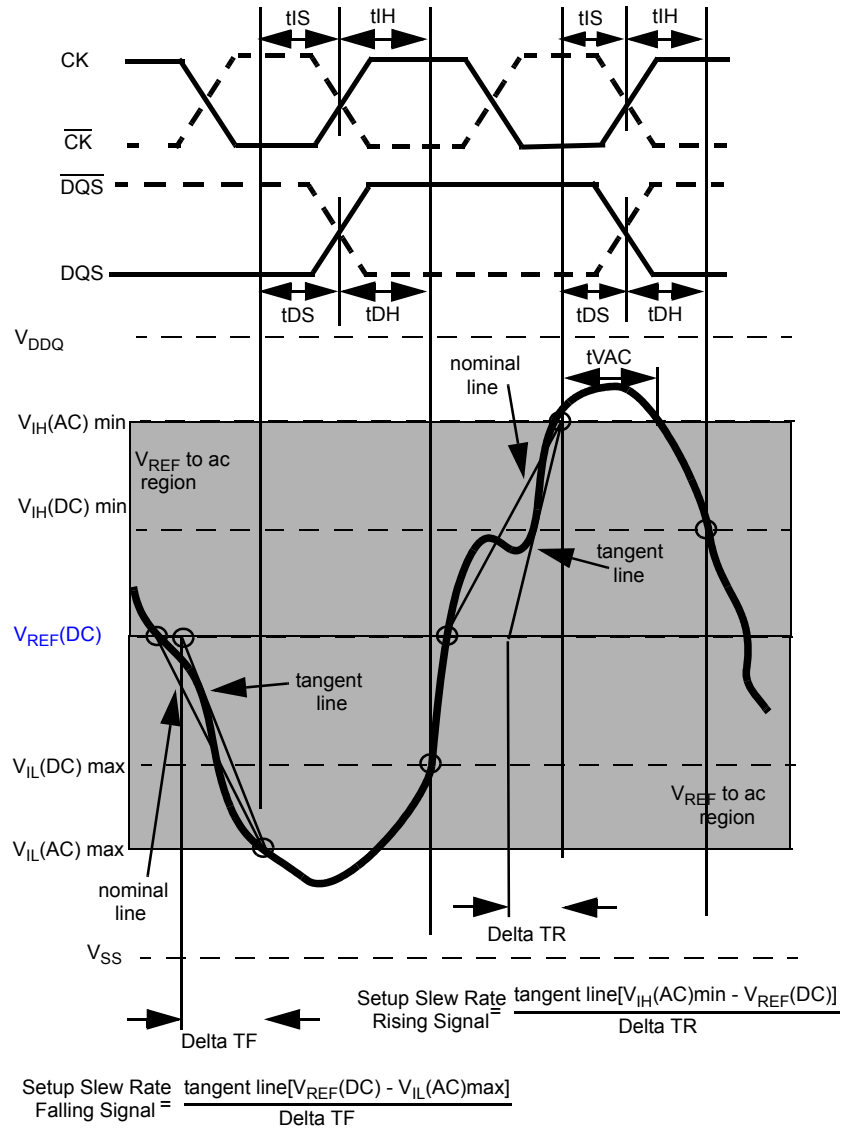

Figure 23. Illustration of tangent line for setup time  $t_{DS}$  (for DQ with respect to strobe) and  $t_{IS}$  (for ADD/CMD with respect to clock)

Note :Clock and Strobe are drawn on a different time scale.

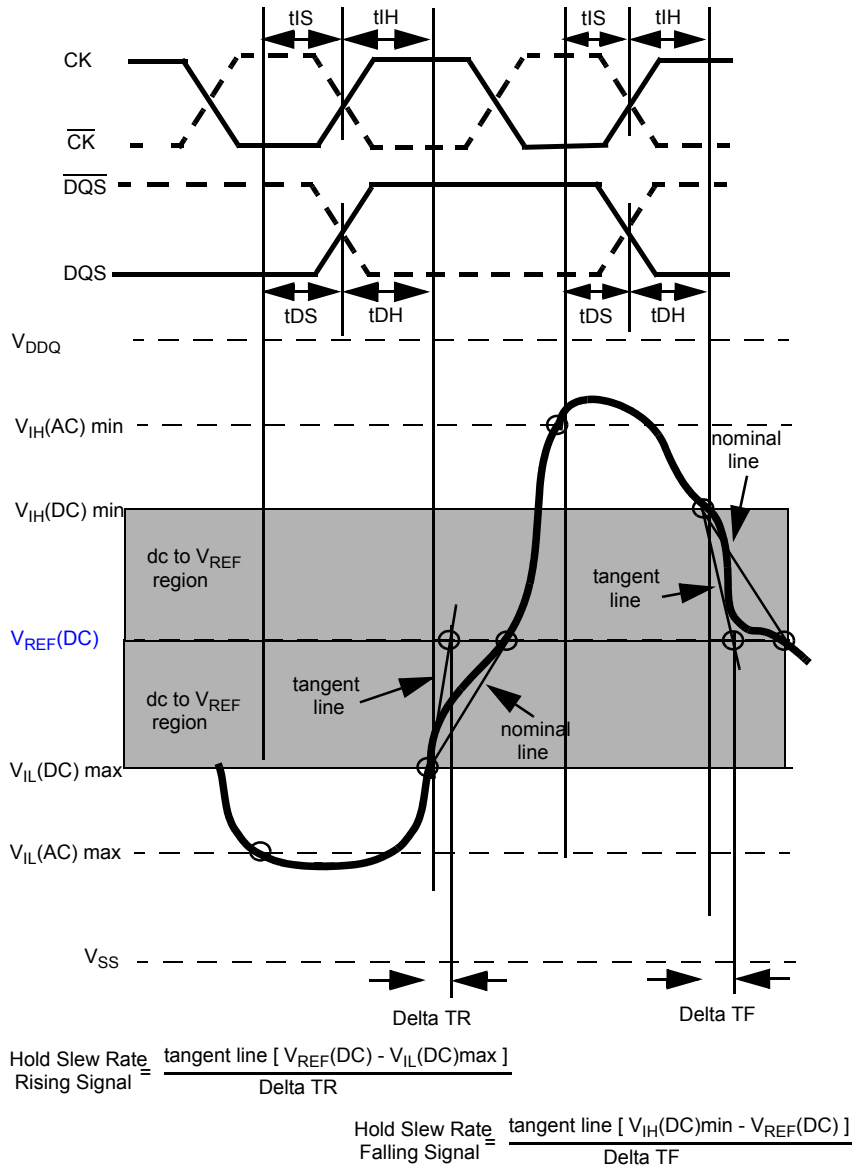

Figure 24 - Illustration of tangent line for hold time tDH (for DQ with respect to strobe) and tIH (for ADD/CMD with respect to clock)

**14.4 Data Setup, Hold and Slew Rate Derating:**

or all input signals the total tDS (setup time) and tDH (hold time) required is calculated by adding the data sheet tDS(base) and tDH(base) value (see Table 52) to the ΔtDS and ΔtDH (see Table 53) derating value respectively. Example: tDS (total setup time) = tDS(base) + ΔtDS.

Setup (tDS) nominal slew rate for a rising signal is defined as the slew rate between the last crossing of VREF(DC) and the first crossing of VIH(AC)min.

Setup (tDS) nominal slew rate for a falling signal is defined as the slew rate between the last crossing of VREF(DC) and the first crossing of VIL(AC)max (see Figure 25). If the actual signal is always earlier than the nominal slew rate line between shaded 'VREF(DC) to ac region', use nominal slew rate for derating value. If the actual signal is later than the nominal slew rate line anywhere

between shaded 'VREF(DC) to ac region', the slew rate of a tangent line to the actual signal from the ac level to dc level is used for derating value (see Figure 27).

Hold (tDH) nominal slew rate for a rising signal is defined as the slew rate between the last crossing of VIL(DC)max and the first crossing of VREF(DC).

Hold (tDH) nominal slew rate for a falling signal is defined as the slew rate between the last crossing of VIH(DC)min and the first crossing of VREF(DC) (see Figure 26). If the actual signal is always later than the nominal slew rate line between shaded 'dc level to VREF(DC) region', use nominal slew rate for derating value. If the actual signal is earlier than the nominal slew rate line anywhere between shaded 'dc to VREF(DC) region', the slew rate of a tangent line to the actual signal from the dc level to VREF(DC) level is used for derating value (see Figure 28).

For a valid transition the input signal has to remain above/below VIH/IL(AC) for some time tVAC (see Table 54).

Although for slow slew rates the total setup time might be negative (i.e. a valid input signal will not have reached VIH/IL(AC) at the time of the rising clock transition) a valid input signal is still required to complete the transition and reach VIH/IL(AC).

For slew rates in between the values listed in the tables the derating values may be obtained by linear interpolation. These values are typically not subject to production test. They are verified by design and characterization

**[ Table 52 ] Data Setup and Hold Base-Value**

[ps]	DDR3-800	DDR3-1066	DDR3-1333	DDR3-1600	reference
tDS(base)	75	25	30	10	VIH/L(AC)
tDH(base)	150	100	65	45	VIH/L(DC)
tDS(AC150)	75+50	25+50	-	-	VIH/L(AC)

Note : AC/DC referenced for 1V/ns DQ-slew rate and 2 V/ns DQS slew rate)

**[ Table 53 ] Derating values DDR3-800/1066/1333/1600 tIS/tIH-ac/dc based**

ΔtDS, ΔtDH Derating [ps] AC/DC based <sup>a</sup>																		
		DQS,DQS Differential Slew Rate																
		4.0 V/ns		3.0 V/ns		2.0 V/ns		1.8 V/ns		1.6 V/ns		1.4V/ns		1.2V/ns		1.0V/ns		
		ΔtDS	ΔtDH	ΔtDS	ΔtDH	ΔtDS	ΔtDH	ΔtDS	ΔtDH	ΔtDS	ΔtDH	ΔtDS	ΔtDH	ΔtDS	ΔtDH	ΔtDS	ΔtDH	
DDR3 - 800/ 1066	DQ Slew rate V/ns	2.0	88	50	88	50	88	50	-	-	-	-	-	-	-	-	-	-
		1.5	59	34	59	34	59	34	67	42	-	-	-	-	-	-	-	-
		1.0	0	0	0	0	0	0	8	8	16	16	-	-	-	-	-	-
		0.9	-	-	-2	-4	-2	-4	6	4	14	12	22	20	-	-	-	-
		0.8	-	-	-	-	-6	-10	2	-2	10	6	18	14	26	24	-	-
		0.7	-	-	-	-	-	-	-3	-8	5	0	13	8	21	18	29	34
		0.6	-	-	-	-	-	-	-	-	-1	-10	7	-2	15	8	23	24
		0.5	-	-	-	-	-	-	-	-	-	-	-11	-16	-2	-6	6	10
0.4	-	-	-	-	-	-	-	-	-	-	-	-	-30	-26	-22	-10		
DDR3 - 1333/ 1600	DQ Slew rate V/ns	2.0	75	50	75	50	75	50	-	-	-	-	-	-	-	-	-	-
		1.5	50	34	50	34	50	34	58	42	-	-	-	-	-	-	-	-
		1.0	0	0	0	0	0	0	8	8	16	16	-	-	-	-	-	-
		0.9	-	-	0	-4	0	-4	8	4	16	12	24	20	-	-	-	-
		0.8	-	-	-	-	0	-10	8	-2	16	6	24	14	32	24	-	-
		0.7	-	-	-	-	-	-	8	-8	16	0	24	8	32	18	40	34
		0.6	-	-	-	-	-	-	-	-	15	-10	23	-2	31	8	39	24
		0.5	-	-	-	-	-	-	-	-	-	-	14	-16	22	-6	30	10
0.4	-	-	-	-	-	-	-	-	-	-	-	-	7	-26	15	-10		

Note : a. Cell contents shaded in red are defined as 'not supported'.

**[ Table 54 ] Required time tVAC above VIH(AC) {blow VIL(AC)} for valid transition**

Slew Rate[V/ns]	tVAC[ps] DDR3-800/1066		tVAC[ps] DDR3-1333/1600	
	min	max	min	max
>2.0	75	-	175	-
2.0	57	-	170	-
1.5	50	-	167	-
1.0	38	-	163	-
0.9	34	-	162	-
0.8	29	-	161	-
0.7	22	-	159	-
0.6	13	-	155	-
0.5	0	-	155	-
<0.5	0	-	150	-

Note :Clock and Strobe are drawn on a different time scale.

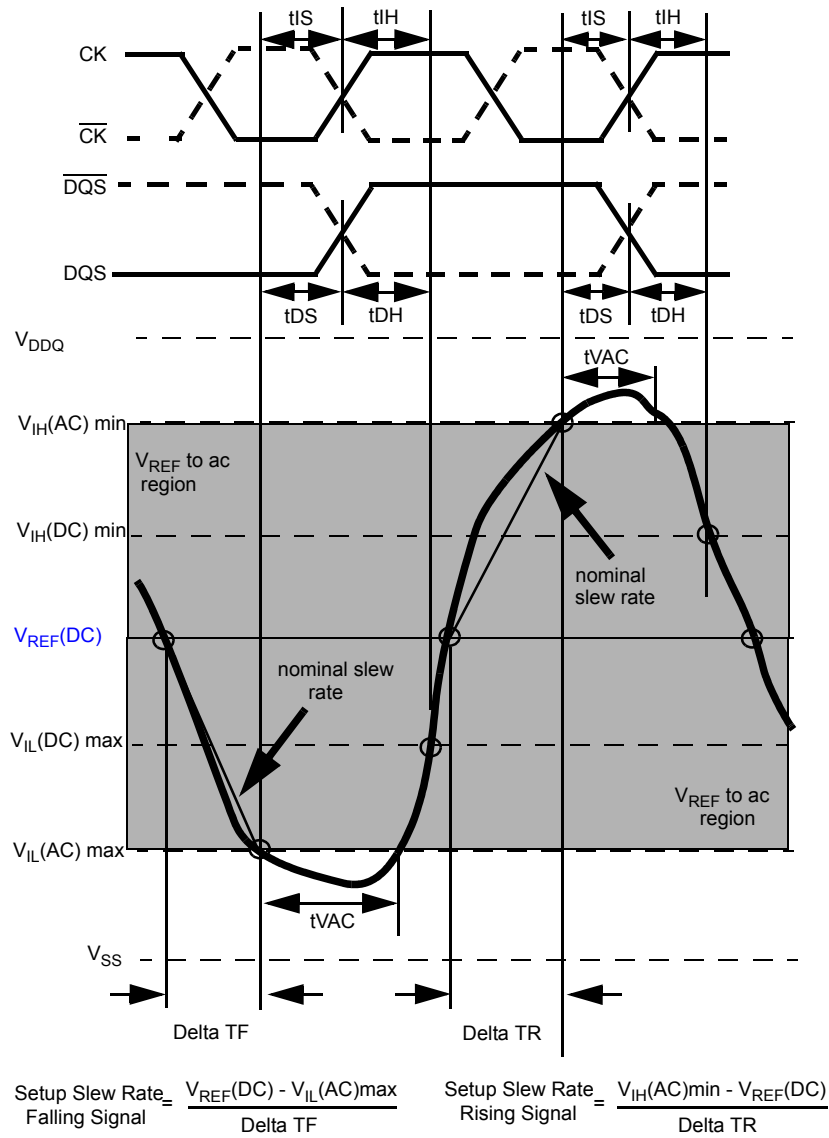

Figure 25 - Illustration of nominal slew rate and tVAC for setup time tDS (for DQ with respect to strobe) and tIS (for ADD/CMD with respect to clock).



Note :Clock and Strobe are drawn on a different time scale.

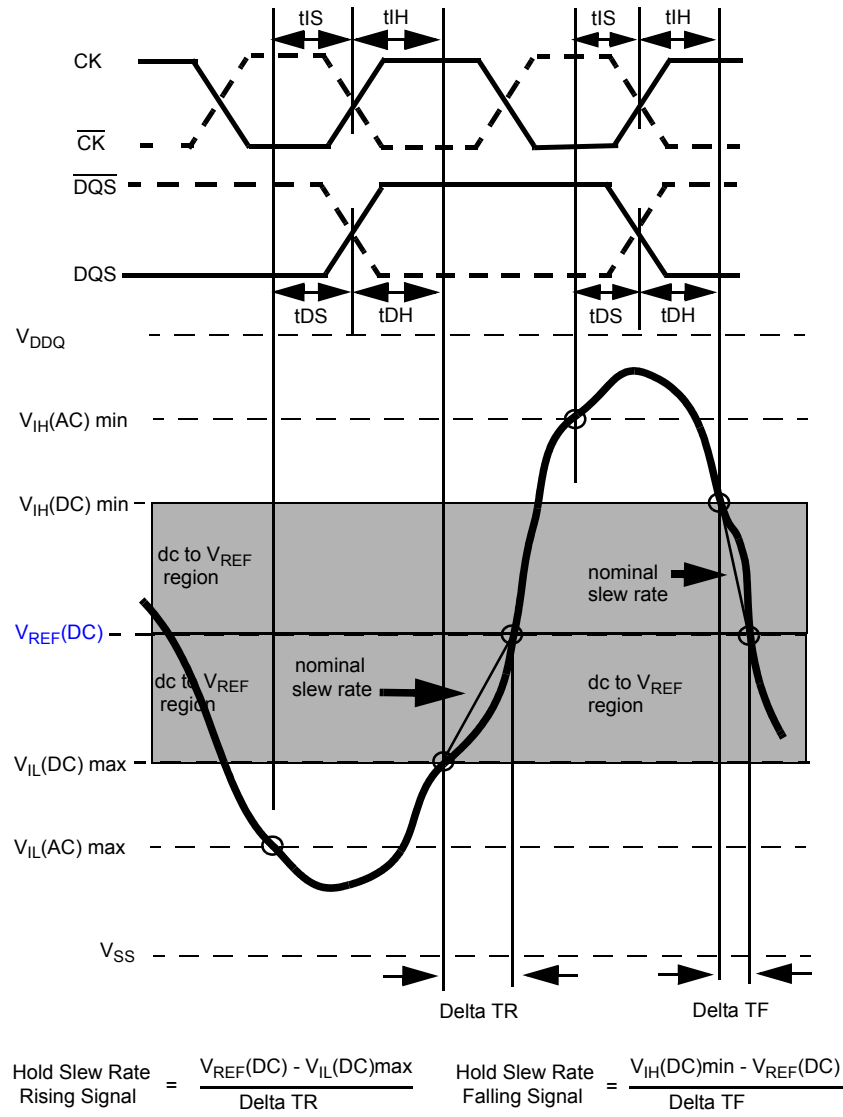

Figure 26 - Illustration of nominal slew rate for hold time  $t_{DH}$  (for DQ with respect to strobe) and  $t_{IH}$  (for ADD/CMD with respect to clock).

Note :Clock and Strobe are drawn on a different time scale.

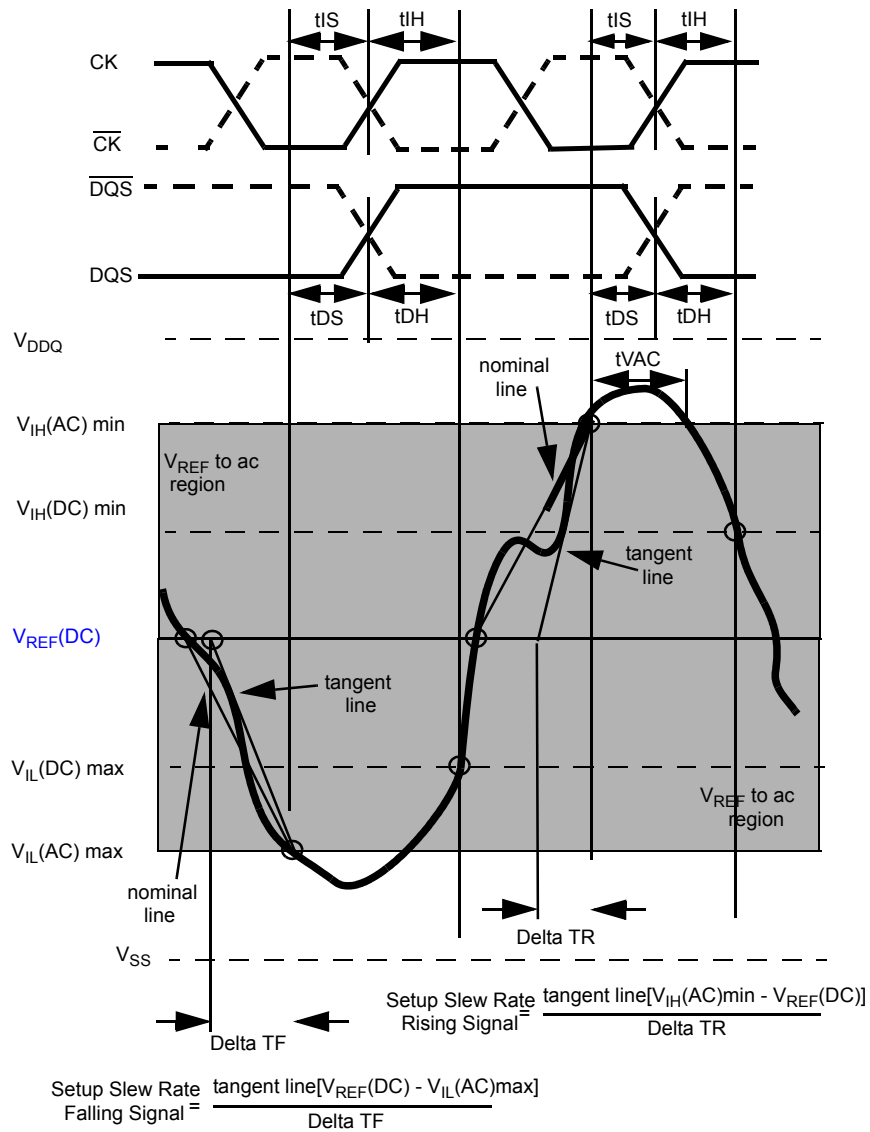

Figure 27 - Illustration of tangent line for setup time  $t_{DS}$  (for DQ with respect to strobe) and  $t_{IS}$  (for ADD/CMD with respect to clock)

Note :Clock and Strobe are drawn on a different time scale.

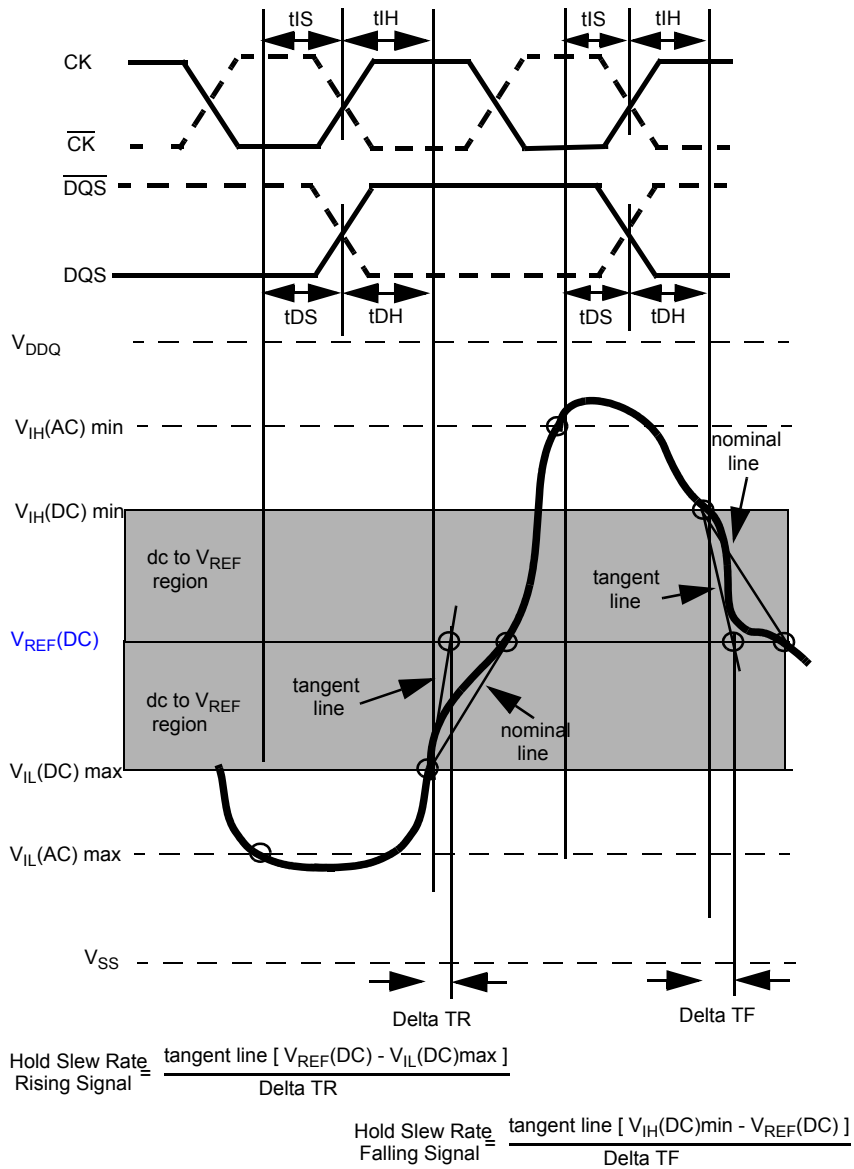

Figure 28 - Illustration of tangent line for hold time tDH (for DQ with respect to strobe) and tIH (for ADD/CMD with respect to clock)