

OptiMOS™3 Power-Transistor
Features

- Ideal for high frequency switching and DC/DC converters
- Excellent gate charge $\times R_{DS(on)}$ product (FOM)
- Very low on-resistance $R_{DS(on)}$
- N-channel, normal level
- 100% avalanche tested
- Pb-free plating; RoHS compliant, halogen free
- Qualified according to JEDEC¹⁾ for target applications

Product Summary

| | | |
|------------------|-----|------------|
| V_{DS} | 120 | V |
| $R_{DS(on),max}$ | 3.6 | m Ω |
| I_D | 180 | A |

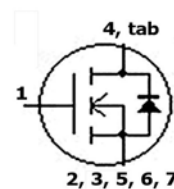

| | |
|----------------|--|
| Type | IPB036N12N3 G |
| |  |
| Package | PG-TO263-7 |
| Marking | 036N12N |

Maximum ratings, at $T_j=25\text{ }^\circ\text{C}$, unless otherwise specified

| Parameter | Symbol | Conditions | Value | Unit |
|--|-------------------|--|-------------|------------------|
| Continuous drain current | I_D | $T_C=25\text{ }^\circ\text{C}^{2)}$ | 180 | A |
| | | $T_C=100\text{ }^\circ\text{C}$ | 139 | |
| Pulsed drain current ²⁾ | $I_{D,pulse}$ | $T_C=25\text{ }^\circ\text{C}$ | 720 | |
| Avalanche energy, single pulse ³⁾ | E_{AS} | $I_D=100\text{ A}$, $R_{GS}=25\text{ }\Omega$ | 900 | mJ |
| Gate source voltage | V_{GS} | | ± 20 | V |
| Power dissipation | P_{tot} | $T_C=25\text{ }^\circ\text{C}$ | 300 | W |
| Operating and storage temperature | T_j , T_{stg} | | -55 ... 175 | $^\circ\text{C}$ |
| IEC climatic category; DIN IEC 68-1 | | | 55/175/56 | |

¹⁾J-STD20 and JESD22

²⁾ See figure 3 for more detailed information

³⁾ See figure 13 for more detailed information

| Parameter | Symbol | Conditions | Values | | | Unit |
|-----------|--------|------------|--------|------|------|------|
| | | | min. | typ. | max. | |

Thermal characteristics

| | | | | | | |
|--|------------|--|---|---|-----|-----|
| Thermal resistance, junction - case | R_{thJC} | | - | - | 0.5 | K/W |
| Thermal resistance, junction - ambient | R_{thJA} | minimal footprint | - | - | 62 | |
| | | 6 cm ² cooling area ⁴⁾ | - | - | 40 | |

Electrical characteristics, at $T_j=25\text{ }^\circ\text{C}$, unless otherwise specified
Static characteristics

| | | | | | | |
|----------------------------------|---------------|---|-----|-----|-----|---------------|
| Drain-source breakdown voltage | $V_{(BR)DSS}$ | $V_{GS}=0\text{ V}, I_D=1\text{ mA}$ | 120 | - | - | V |
| Gate threshold voltage | $V_{GS(th)}$ | $V_{DS}=V_{GS}, I_D=270\text{ }\mu\text{A}$ | 2 | 3 | 4 | |
| Zero gate voltage drain current | I_{DSS} | $V_{DS}=100\text{ V}, V_{GS}=0\text{ V}, T_j=25\text{ }^\circ\text{C}$ | - | 0.1 | 1 | μA |
| | | $V_{DS}=100\text{ V}, V_{GS}=0\text{ V}, T_j=125\text{ }^\circ\text{C}$ | - | 10 | 100 | |
| Gate-source leakage current | I_{GSS} | $V_{GS}=20\text{ V}, V_{DS}=0\text{ V}$ | - | 1 | 100 | nA |
| Drain-source on-state resistance | $R_{DS(on)}$ | $V_{GS}=10\text{ V}, I_D=100\text{ A}$ | - | 2.9 | 3.6 | m Ω |
| Gate resistance | R_G | | - | 1.4 | - | Ω |
| Transconductance | g_{fs} | $ V_{DS} >2 I_D R_{DS(on)max}, I_D=100\text{ A}$ | 98 | 195 | - | S |

⁴⁾ Device on 40 mm x 40 mm x 1.5 mm epoxy PCB FR4 with 6 cm² (one layer, 70 μm thick) copper area for drain connection. PCB is vertical in still air.

| Parameter | Symbol | Conditions | Values | | | Unit |
|-----------|--------|------------|--------|------|------|------|
| | | | min. | typ. | max. | |

Dynamic characteristics

| | | | | | | |
|------------------------------|--------------|--|---|-------|-------|----|
| Input capacitance | C_{iss} | $V_{GS}=0\text{ V}, V_{DS}=60\text{ V},$ $f=1\text{ MHz}$ | - | 10400 | 13800 | pF |
| Output capacitance | C_{oss} | | - | 1320 | 1760 | |
| Reverse transfer capacitance | C_{rss} | | - | 61 | - | |
| Turn-on delay time | $t_{d(on)}$ | $V_{DD}=60\text{ V}, V_{GS}=10\text{ V},$ $I_D=100\text{ A}, R_G=1.6\ \Omega$ | - | 35 | - | ns |
| Rise time | t_r | | - | 52 | - | |
| Turn-off delay time | $t_{d(off)}$ | | - | 76 | - | |
| Fall time | t_f | | - | 21 | - | |

Gate Charge Characteristics⁵⁾

| | | | | | | |
|-----------------------|---------------|---|---|-----|-----|----|
| Gate to source charge | Q_{gs} | $V_{DD}=60\text{ V}, I_D=100\text{ A},$ $V_{GS}=0\text{ to }10\text{ V}$ | - | 52 | - | nC |
| Gate to drain charge | Q_{gd} | | - | 37 | - | |
| Switching charge | Q_{sw} | | - | 57 | - | |
| Gate charge total | Q_g | | - | 158 | 211 | |
| Gate plateau voltage | $V_{plateau}$ | | - | 5.0 | - | |
| Output charge | Q_{oss} | $V_{DD}=60\text{ V}, V_{GS}=0\text{ V}$ | - | 182 | 242 | nC |

Reverse Diode

| | | | | | | |
|----------------------------------|---------------|--|---|-----|-----|----|
| Diode continuous forward current | I_S | $T_C=25\text{ }^\circ\text{C}$ | - | - | 180 | A |
| Diode pulse current | $I_{S,pulse}$ | | - | - | 720 | |
| Diode forward voltage | V_{SD} | $V_{GS}=0\text{ V}, I_F=100\text{ A},$ $T_j=25\text{ }^\circ\text{C}$ | - | 0.9 | 1.2 | V |
| Reverse recovery time | t_{rr} | $V_R=37.5\text{ V}, I_F=I_S,$ $di_F/dt=100\text{ A}/\mu\text{s}$ | - | 123 | - | ns |
| Reverse recovery charge | Q_{rr} | | - | 356 | - | nC |

⁵⁾ See figure 16 for gate charge parameter definition

1 Power dissipation

$$P_{\text{tot}} = f(T_C)$$

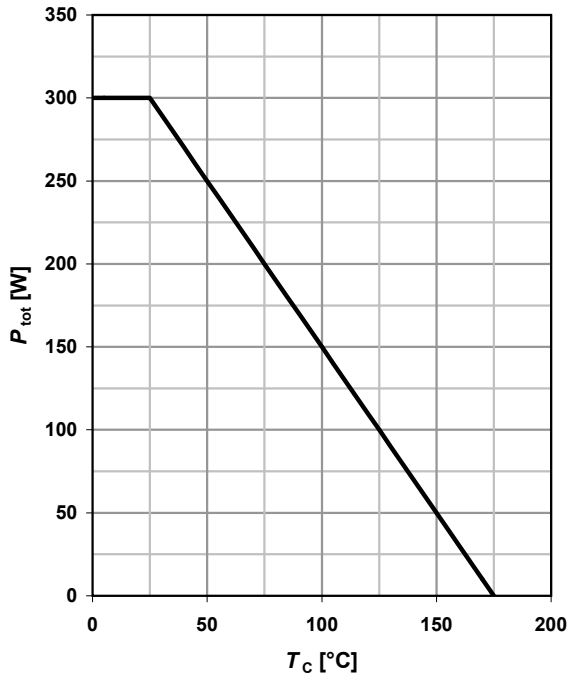

2 Drain current

$$I_D = f(T_C); V_{\text{GS}} \geq 10 \text{ V}$$

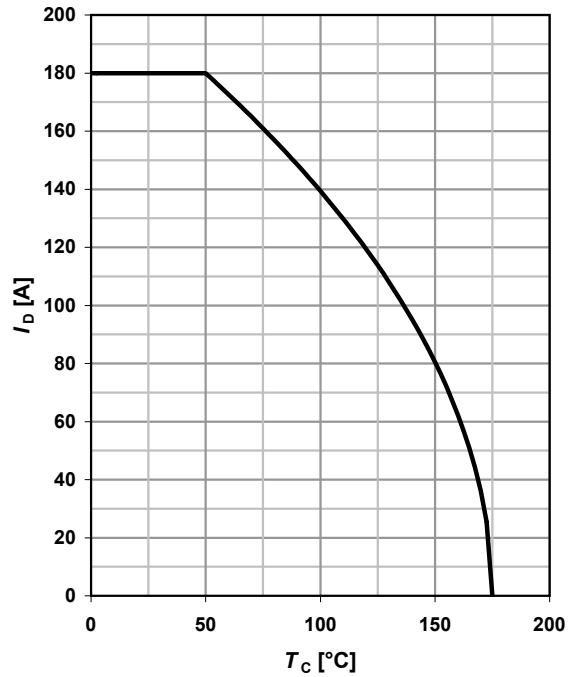

3 Safe operating area

$$I_D = f(V_{\text{DS}}); T_C = 25 \text{ °C}; D = 0$$

parameter: t_p

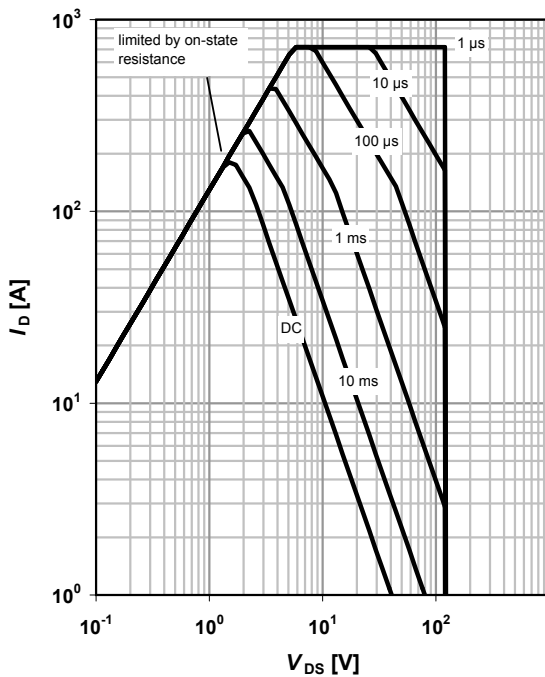

4 Max. transient thermal impedance

$$Z_{\text{thJC}} = f(t_p)$$

parameter: $D = t_p / T$

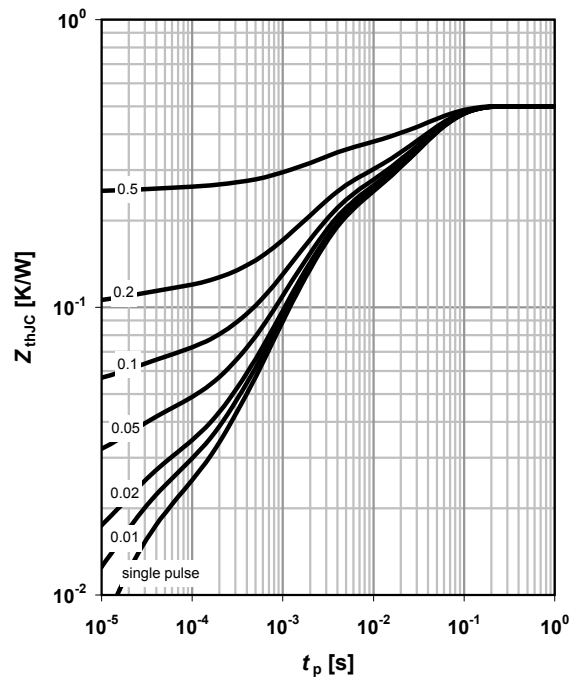

5 Typ. output characteristics

$I_D = f(V_{DS}); T_j = 25\text{ }^\circ\text{C}$

parameter: V_{GS}

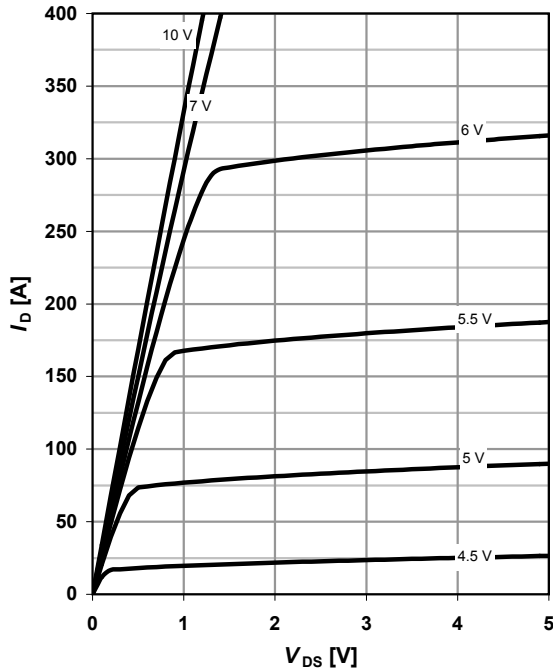

6 Typ. drain-source on resistance

$R_{DS(on)} = f(I_D); T_j = 25\text{ }^\circ\text{C}$

parameter: V_{GS}

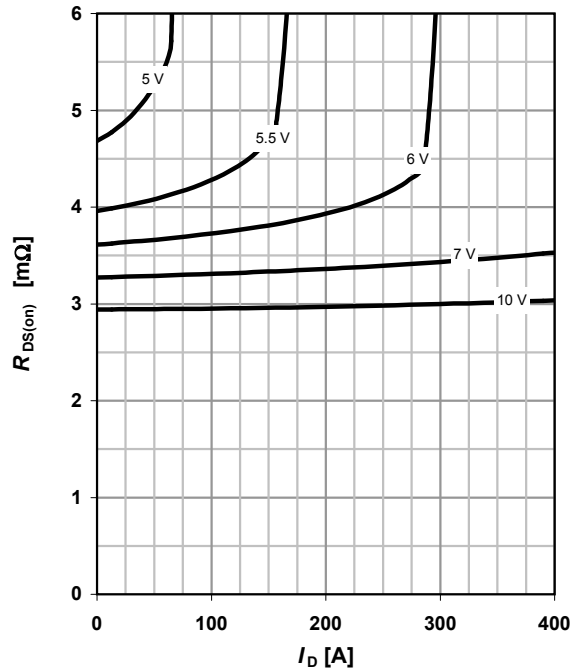

7 Typ. transfer characteristics

$I_D = f(V_{GS}); |V_{DS}| > 2|I_D|R_{DS(on)max}$

parameter: T_j

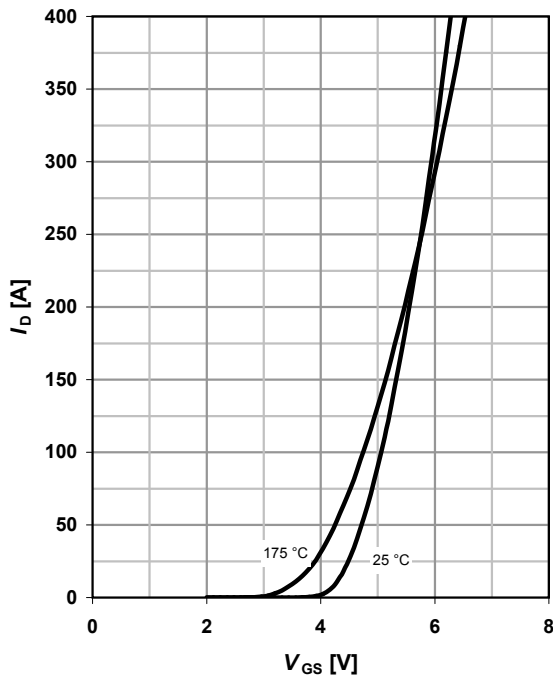

8 Typ. forward transconductance

$g_{fs} = f(I_D); T_j = 25\text{ }^\circ\text{C}$

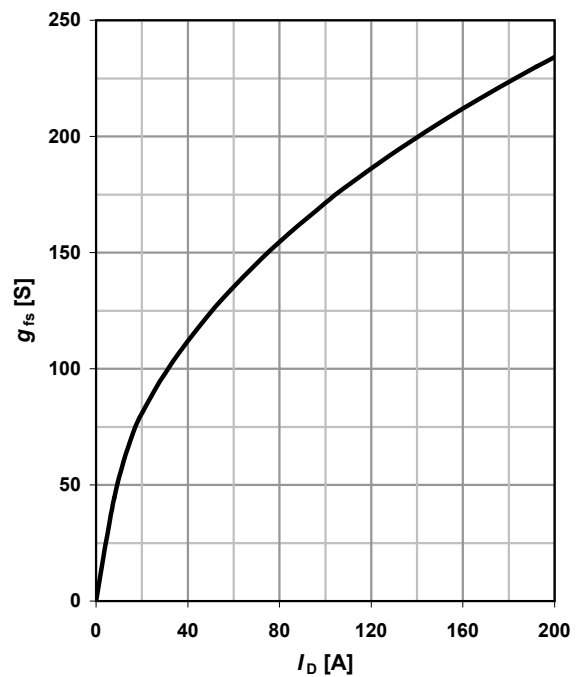

9 Drain-source on-state resistance

$R_{DS(on)} = f(T_j); I_D = 100 \text{ A}; V_{GS} = 10 \text{ V}$

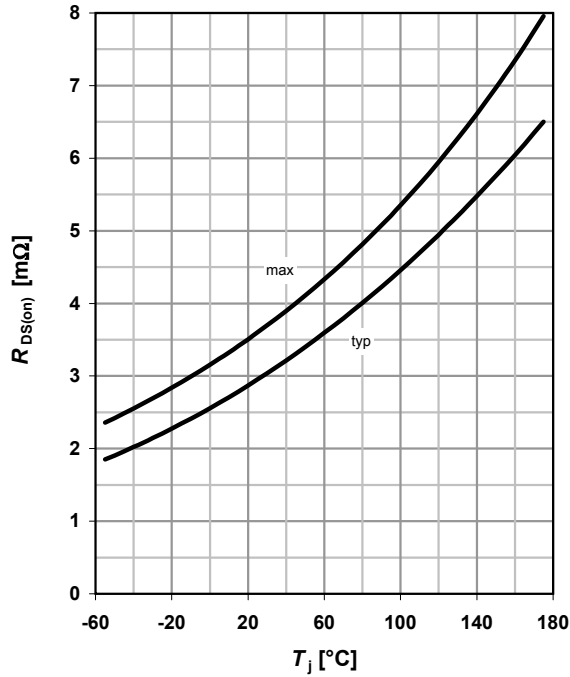

10 Typ. gate threshold voltage

$V_{GS(th)} = f(T_j); V_{GS} = V_{DS}$

parameter: I_D

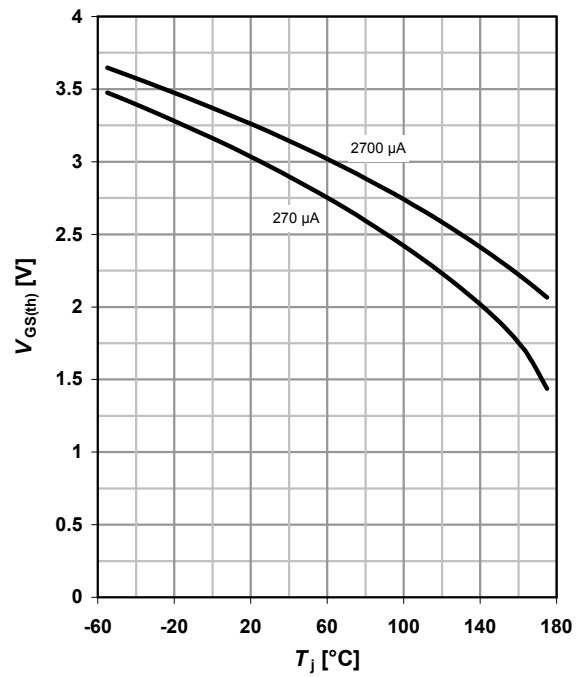

11 Typ. capacitances

$C = f(V_{DS}); V_{GS} = 0 \text{ V}; f = 1 \text{ MHz}$

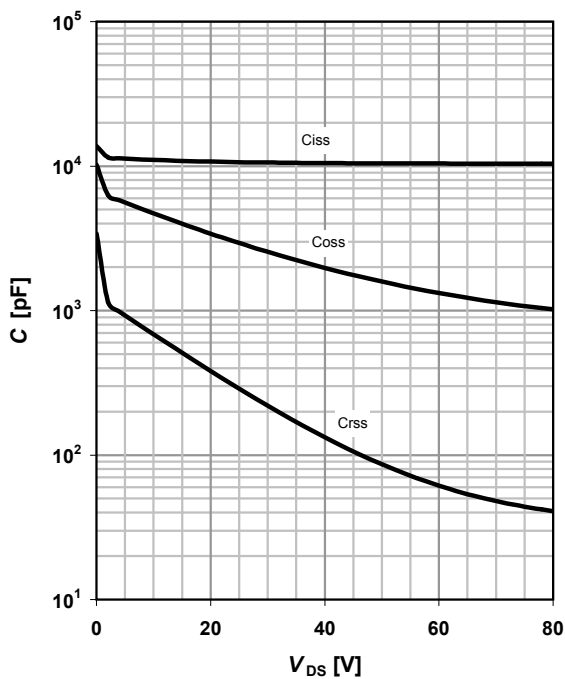

12 Forward characteristics of reverse diode

$I_F = f(V_{SD})$

parameter: T_j

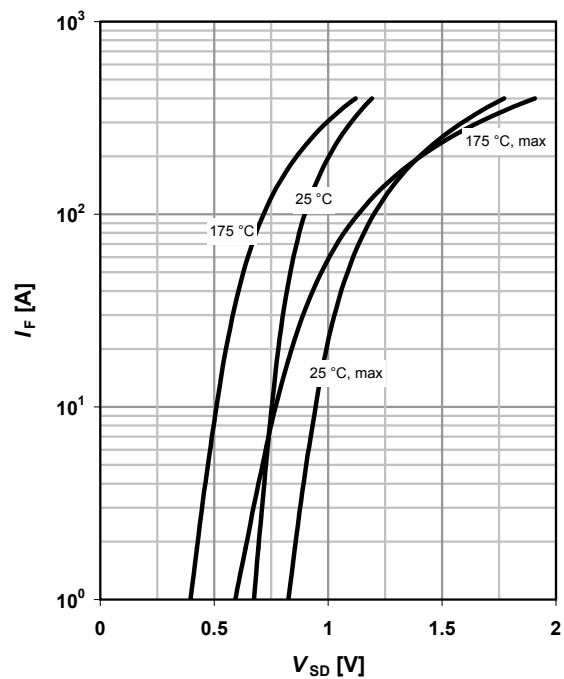

13 Avalanche characteristics

$I_{AS}=f(t_{AV}); R_{GS}=25 \Omega$

parameter: $T_{j(start)}$

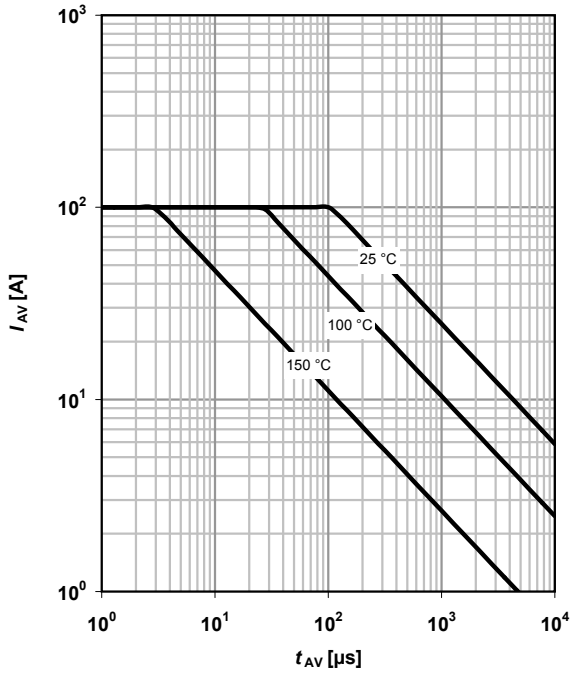

14 Typ. gate charge

$V_{GS}=f(Q_{gate}); I_D=100 \text{ A pulsed}$

parameter: V_{DD}

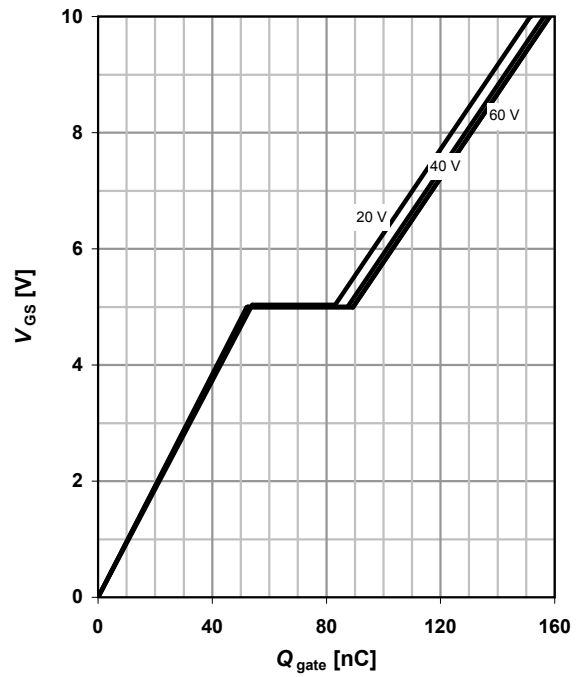

15 Drain-source breakdown voltage

$V_{BR(DSS)}=f(T_j); I_D=1 \text{ mA}$

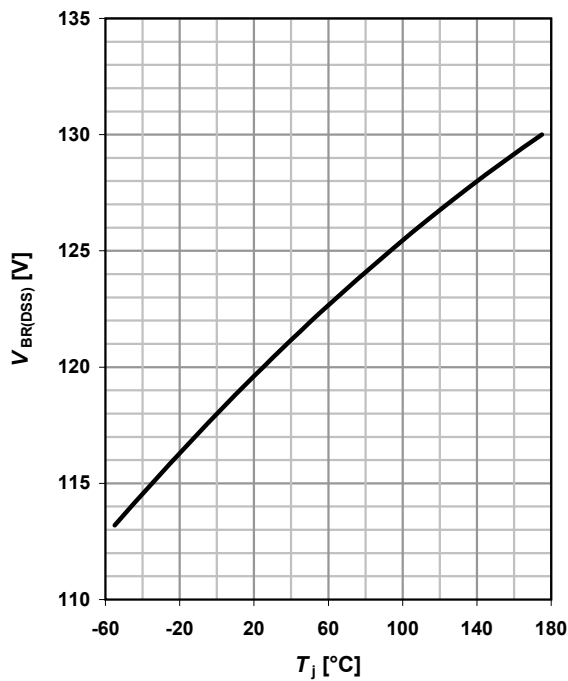

16 Gate charge waveforms



PG-TO263-7

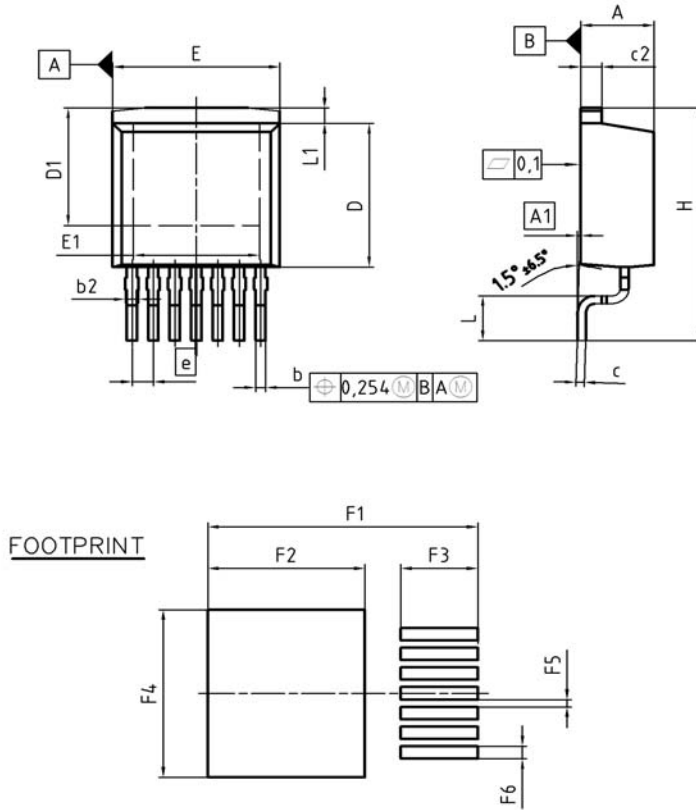

| DIM | MILLIMETERS | | INCHES | |
|-----|-------------|-------|--------|-------|
| | MIN | MAX | MIN | MAX |
| A | 4.30 | 4.57 | 0.169 | 0.180 |
| A1 | 0.00 | 0.25 | 0.000 | 0.010 |
| b | 0.50 | 0.70 | 0.020 | 0.028 |
| b2 | 0.50 | 1.00 | 0.020 | 0.039 |
| c | 0.33 | 0.65 | 0.013 | 0.026 |
| c2 | 1.17 | 1.40 | 0.046 | 0.055 |
| D | 8.51 | 9.45 | 0.335 | 0.372 |
| D1 | 6.90 | 7.90 | 0.272 | 0.311 |
| E | 9.80 | 10.31 | 0.386 | 0.406 |
| E1 | 6.50 | 8.60 | 0.256 | 0.339 |
| e | 1.27 | | 0.050 | |
| N | 7 | | 7 | |
| H | 14.61 | 15.88 | 0.575 | 0.625 |
| L | 2.29 | 3.00 | 0.090 | 0.118 |
| L1 | 0.70 | 1.60 | 0.028 | 0.063 |
| F1 | 16.05 | 16.25 | 0.632 | 0.640 |
| F2 | 9.30 | 9.50 | 0.366 | 0.374 |
| F3 | 4.50 | 4.70 | 0.177 | 0.185 |
| F4 | 10.70 | 10.90 | 0.421 | 0.429 |
| F5 | 0.37 | 0.57 | 0.015 | 0.022 |
| F6 | 0.70 | 0.90 | 0.028 | 0.035 |

DOCUMENT NO.
Z8B00134764

SCALE

EUROPEAN PROJECTION

ISSUE DATE
05-11-2007

REVISION
01

Published by
Infineon Technologies AG
81726 Munich, Germany
© 2009 Infineon Technologies AG
All Rights Reserved.

Legal Disclaimer

The information given in this document shall in no event be regarded as a guarantee of conditions or characteristics. With respect to any examples or hints given herein, any typical values stated herein and/or any information regarding the application of the device, Infineon Technologies hereby disclaims any and all warranties and liabilities of any kind, including without limitation, warranties of non-infringement of intellectual property rights of any third party.

Information

For further information on technology, delivery terms and conditions and prices, please contact the nearest Infineon Technologies Office (www.infineon.com).

Warnings

Due to technical requirements, components may contain dangerous substances. For information on the types in question, please contact the nearest Infineon Technologies Office. Infineon Technologies components may be used in life-support devices or systems only with the express written approval of Infineon Technologies, if a failure of such components can reasonably be expected to cause the failure of that life-support device or system or to affect the safety or effectiveness of that device or system. Life support devices or systems are intended to be implanted in the human body or to support and/or maintain and sustain and/or protect human life. If they fail, it is reasonable to assume that the health of the user or other persons may be endangered.