

DomiLED[™]

Synonymous with function and performance, the DomiLED[™] series is perfectly suited for a variety of cross-industrial applications due to its small package outline, durability and superior brightness.

Features:

- > High brightness surface mount LED using thin film technology.
- > 120° viewing angle.
- > Small package outline (LxWxH) of 3.2 x 2.8 x 1.8mm.
- > Qualified according to JEDEC moisture sensitivity Level 2.
- > Compatible to both IR reflow soldering.
- > Environmental friendly; RoHS compliance.

Applications:

- > Automotive: interior applications, eg: switches, telematics, climate control system, dashboard, etc.
- > Display: full color display video notice board.
- > Industry: white goods (eg: Oven, microwave, etc.).



Optical Characteristics at Tj=25°C

Part Ordering Number	Color	Viewing Angle°	Luminous Intensity @ IF = 20mA IV (mcd)		
			Min.	Typ.	Max.
DRS-NRS-TU1-1	Super Red, 632nm	120	285.0	355.0	560.0
DRR-NRS-T2U-1	Red, 625nm	120	355.0	450.0	715.0
DRA-NRS-UV1-1	Amber, 615nm	120	450.0	560.0	900.0
DRO-NRS-UV1-1	Orange, 605nm	120	450.0	560.0	900.0
DRY-NRS-UV1-1	Yellow, 587nm	120	450.0	560.0	900.0

NOTE

1. All part number above comes in a quantity of 2000 units per reel.
2. Luminous intensity is measured with an accuracy of ± 11%.
3. Wavelength binning is carried for all units as per the wavelength-binning table. Only one wavelength group is allowed for each reel.
4. An optional Vf binning is also available upon request. Binning scheme is as per following table.

Electrical Characteristics at Tj=25°C

Part Number	Vf @ If = 20mA			Vr @ Ir = 10uA
	Min. (V)	Typ. (V)	Max. (V)	Min. (V)
DRx-NRS	1.8	2.1	2.6	12

Forward voltages are measure using a current pulse of 1 ms and with an accuracy of ± 0.1V.

Absolute Maximum Ratings

	Maximum Value	Unit
DC forward current	50	mA
Peak pulse current; (tp ≤ 10µs, Duty cycle = 0.10)	100	mA
Reverse voltage	12	V
ESD threshold (HBM)	2	kV
LED junction temperature	120	°C
Operating temperature	-40 ... +100	°C
Storage temperature	-40 ... +100	°C
Power dissipation (at room temperature)	80	mW

Wavelength Grouping at Tj=25°C

Color	Group	Wavelength distribution (nm)
DRS; Super Red	Full	625 - 640
DRR; Red	Full	620 - 630
DRA; Amber	Full	610 - 621
	W	610 - 615
	X	615 - 621
DRO; Orange	Full	600 - 612
	W	600 - 603
	X	603 - 606
	Y	606 - 609
	Z	609 - 612
DRY; Yellow	Full	582 - 594
	W	582 - 585
	X	585 - 588
	Y	588 - 591
	Z	591 - 594

Dominant wavelength is measured with an accuracy of ± 1 nm.

Luminous Intensity Group at Tj=25°C

Brightness Group	Luminous Intensity @ IV (mcd)
T1	285.0...355.0
T2	355.0...450.0
U1	450.0...560.0
U2	560.0...715.0
V1	715.0...900.0

Luminous intensity is measured with an accuracy of $\pm 11\%$.

Relative Intensity Vs Forward Current

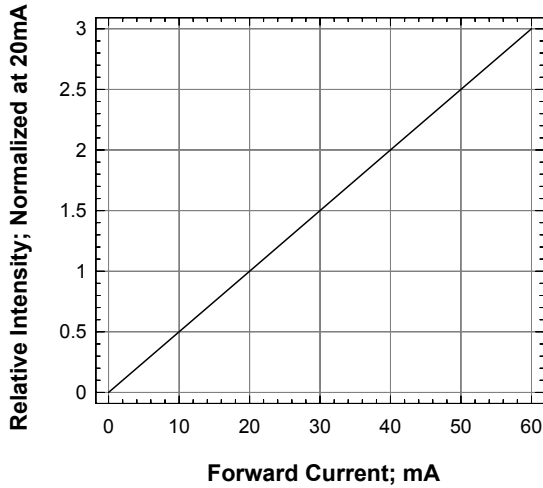

Forward Voltage Vs Forward Current

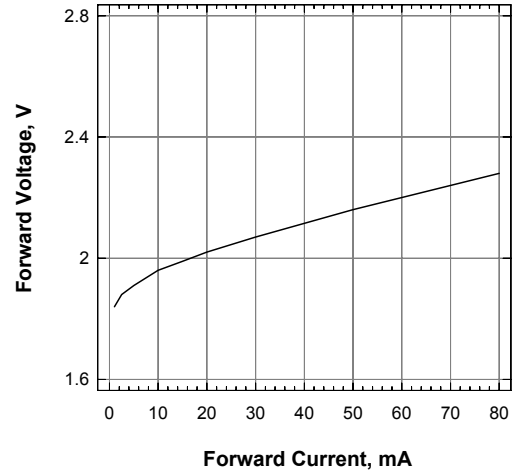

Forward Current Vs Ambient Temperature

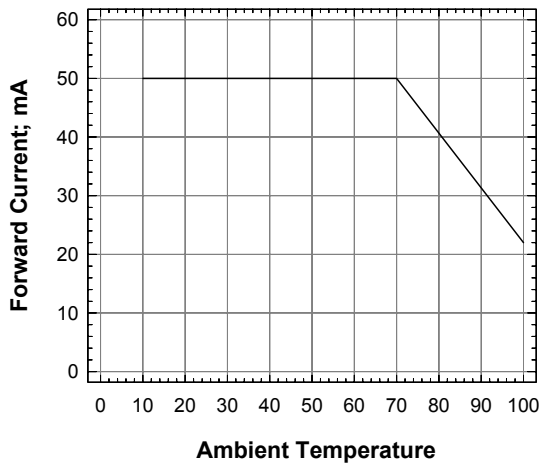

Relative Intensity Vs Wavelength

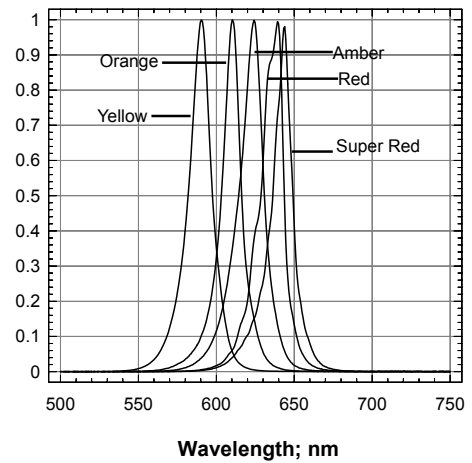

Maximum Pulse Current Vs Duty Cycle

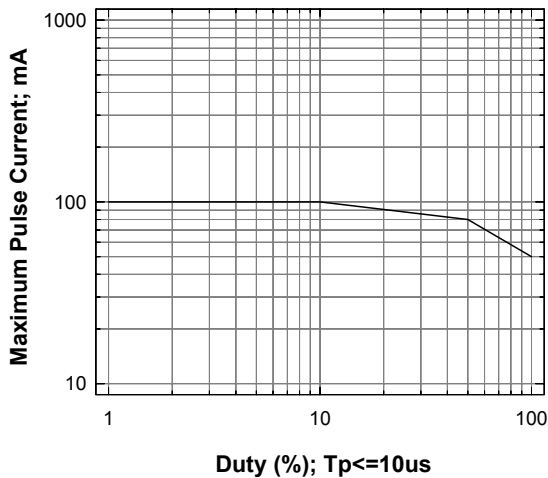

Radiation Pattern

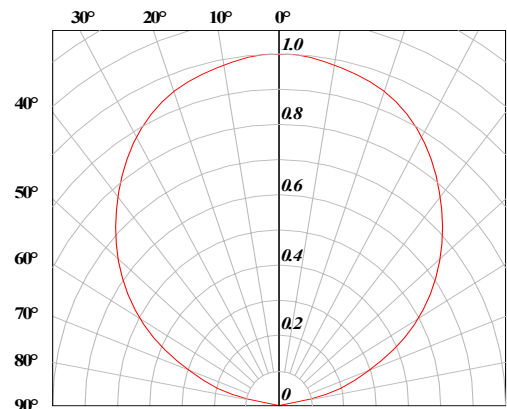

DomiLED™ • AllnGaP : DRx-NRS Package Outlines

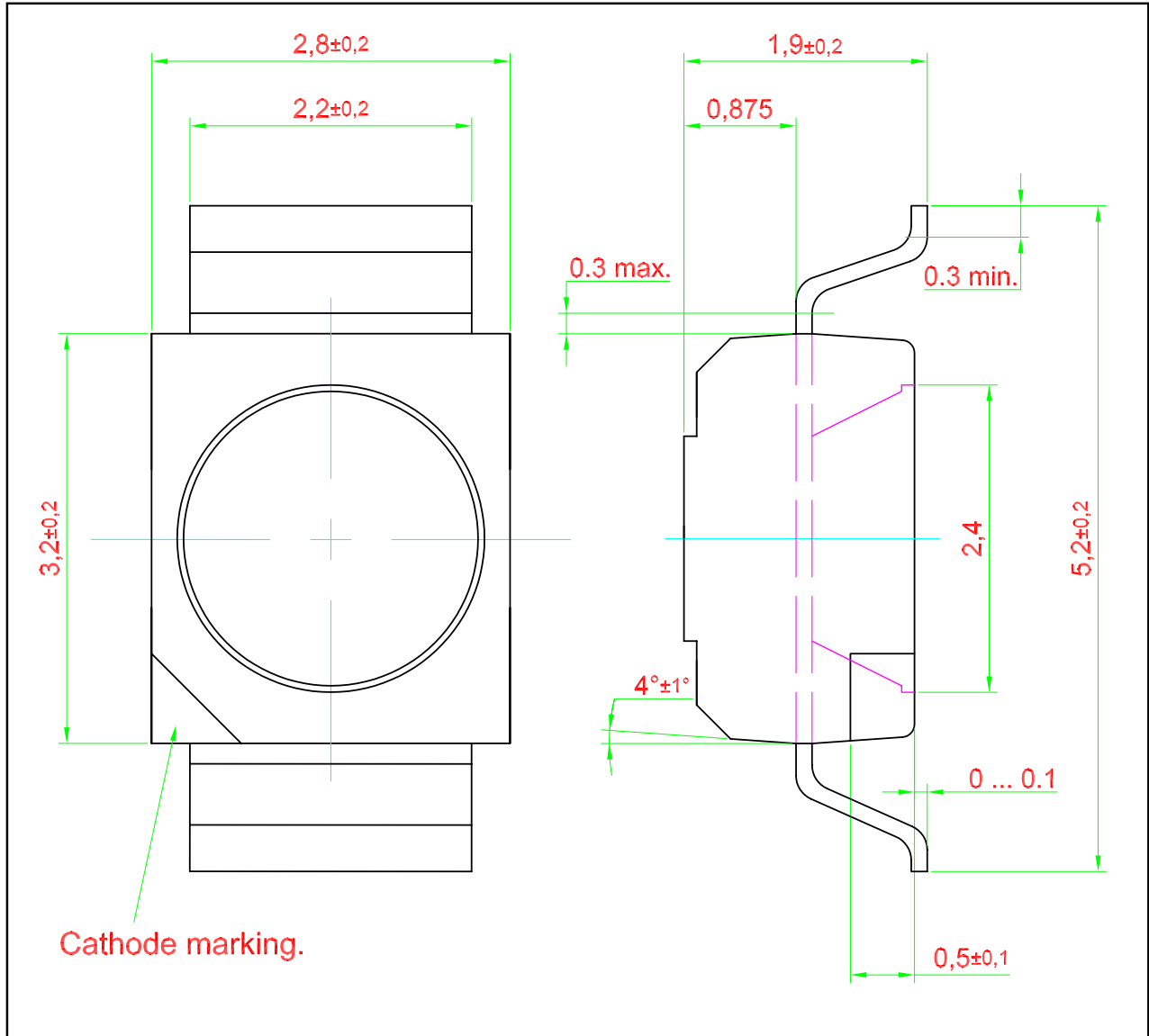

Material

Material	
Lead-frame	Cu Alloy With Ag Plating
Package	High Temperature Resistant Plastic, PPA
Encapsulant	Epoxy
Soldering Leads	Sn-Sn Plating

Recommended Solder Pad

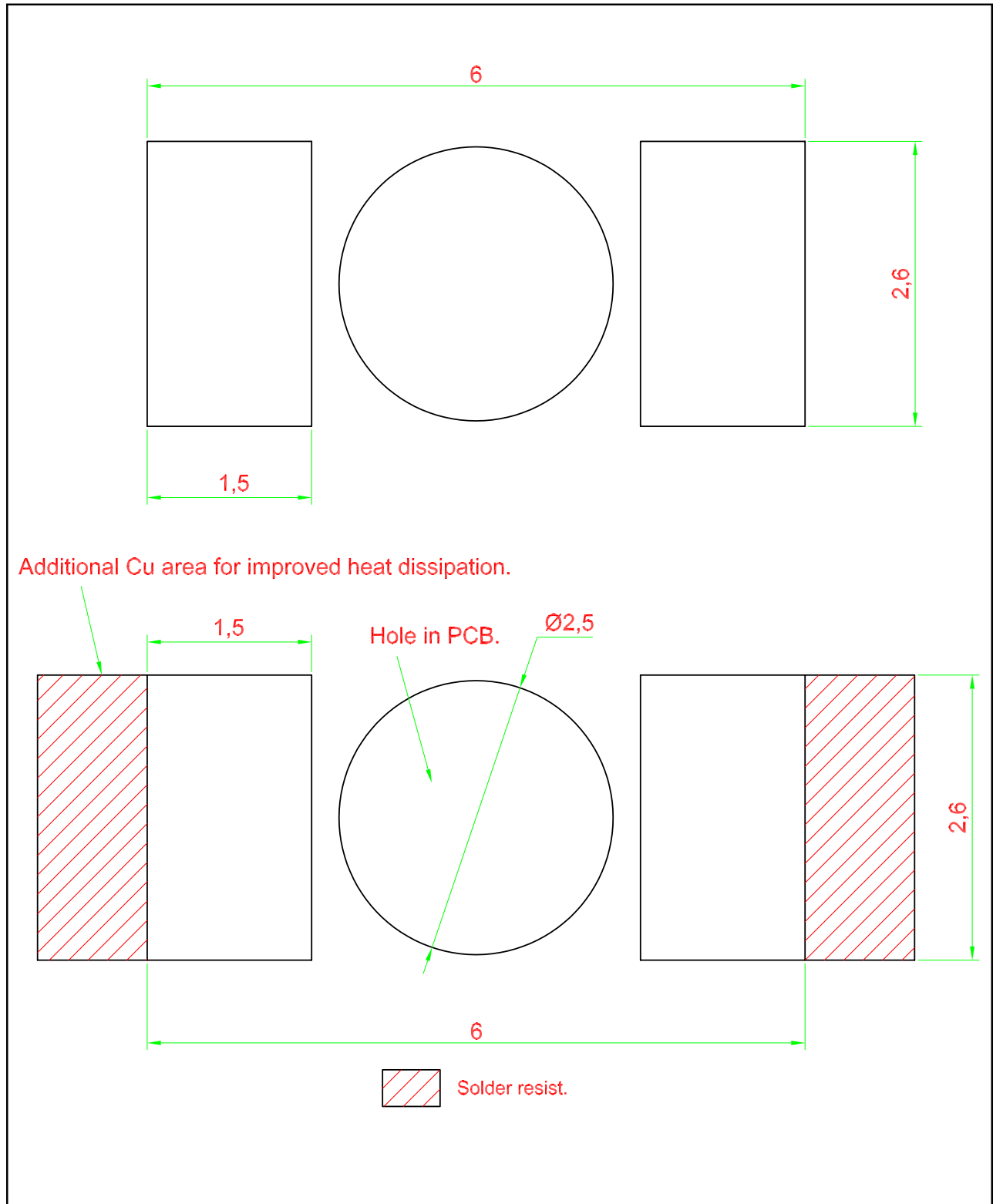

Taping and orientation

- Reels come in quantity of 2000 units.
- Reel diameter is 180 mm.

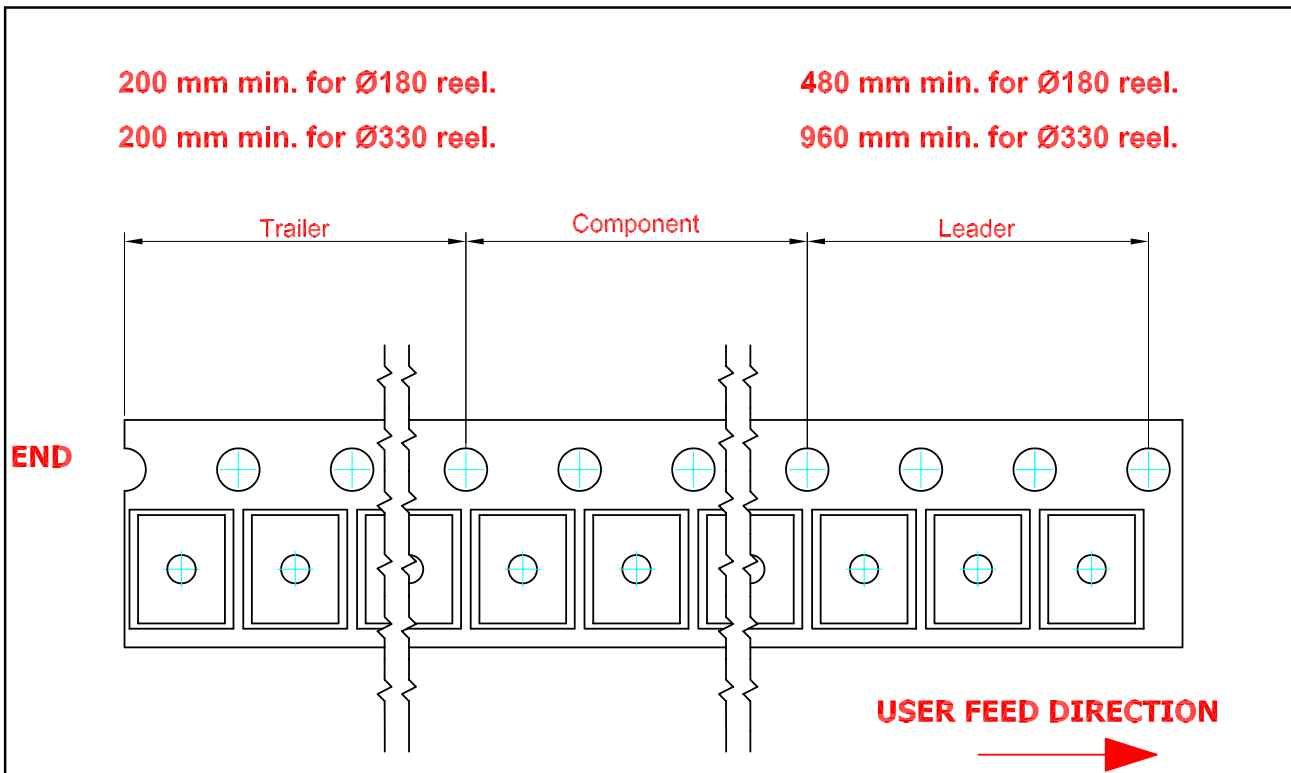
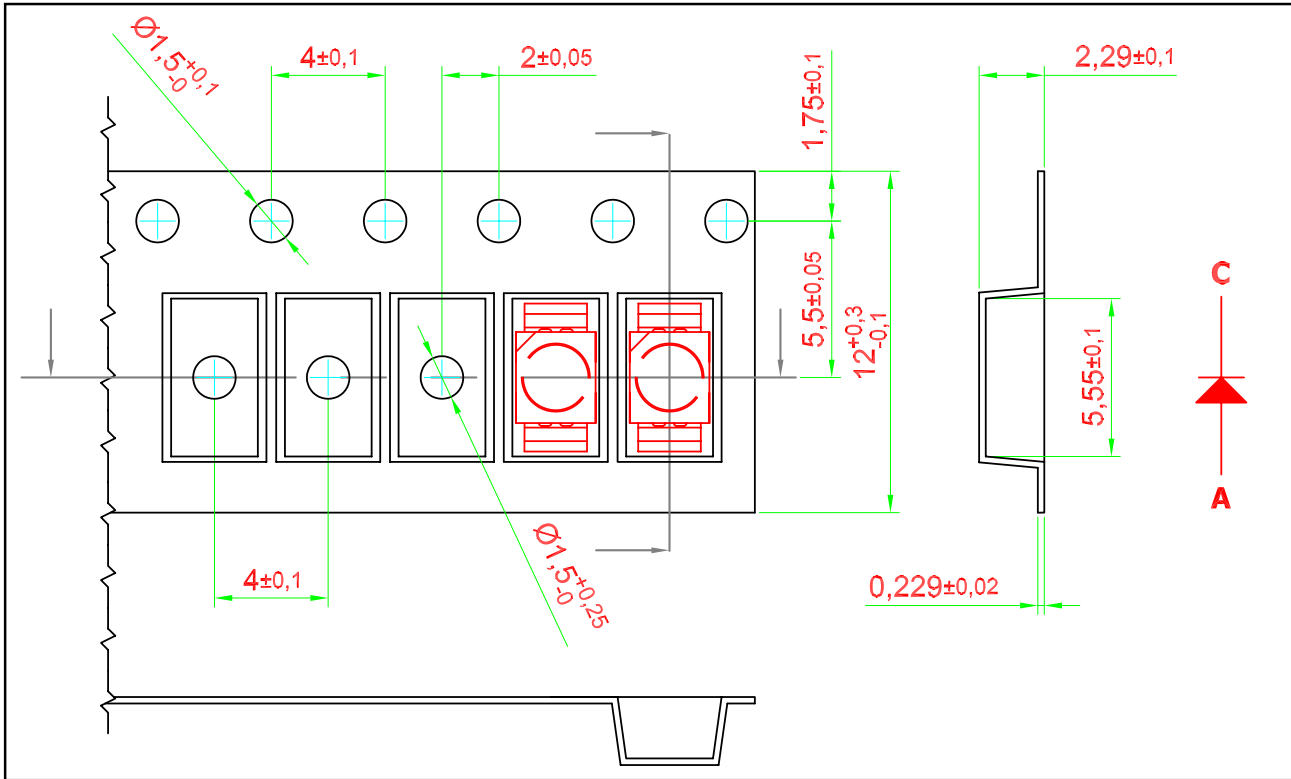

Packaging Specification

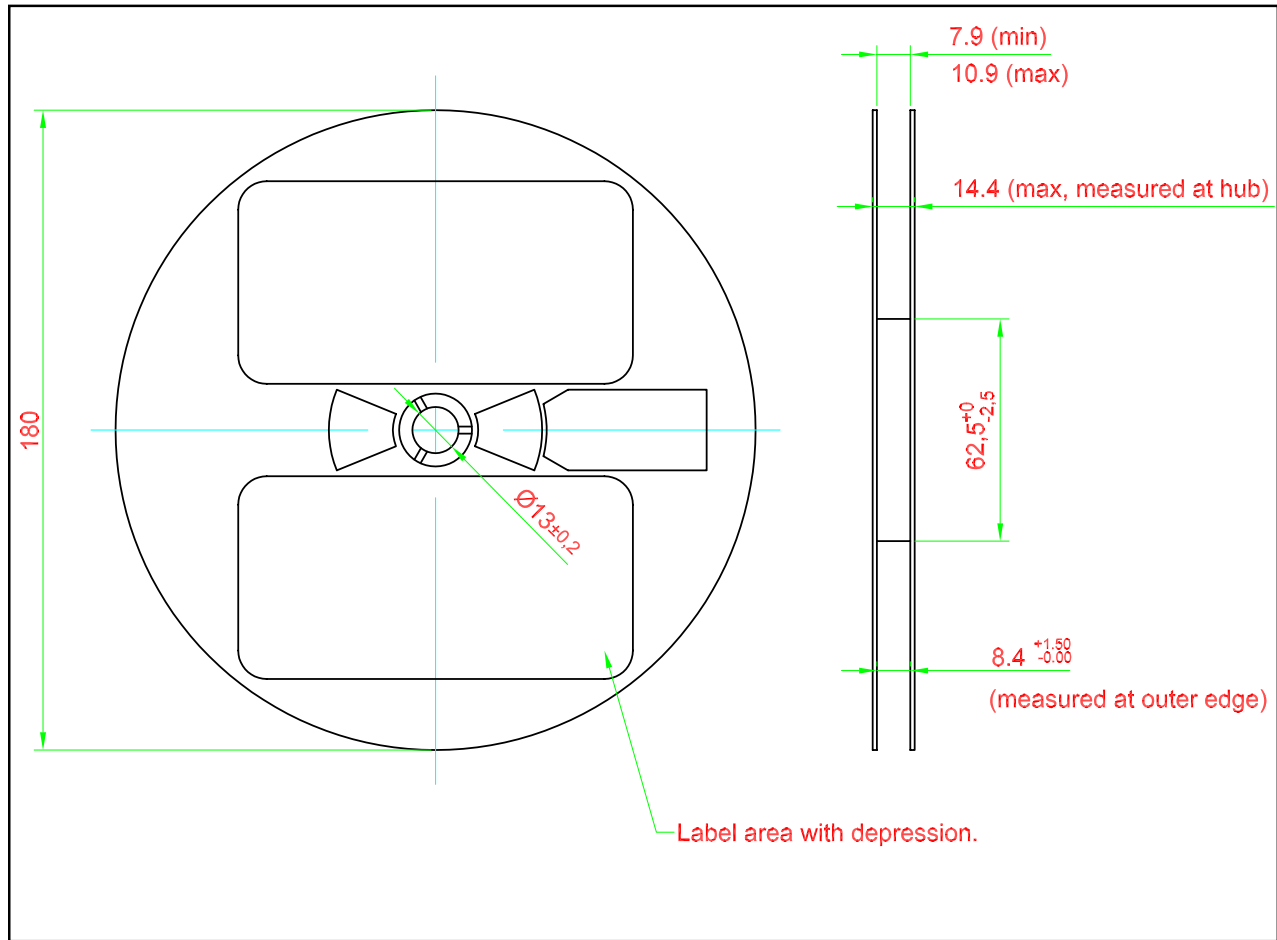

Packaging Specification

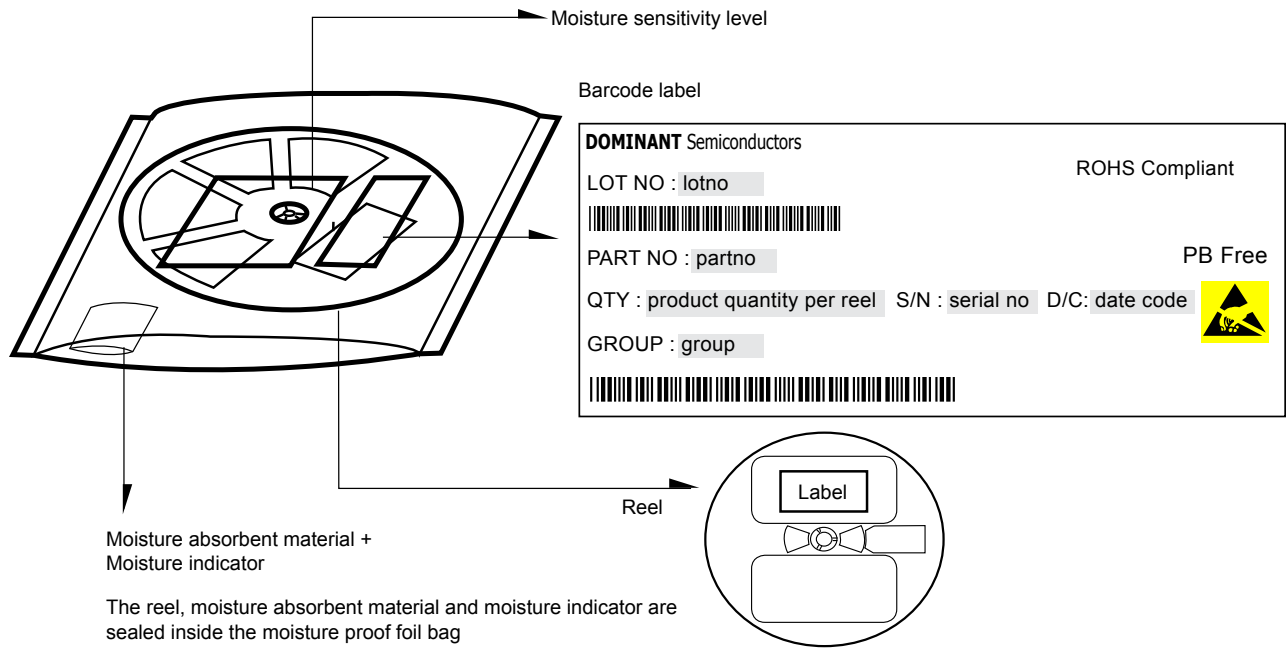

	Average 1pc DomiLED/Multi DomiLED	1 completed bag (2000pcs)
Weight (gram)	0.034	190 ± 10

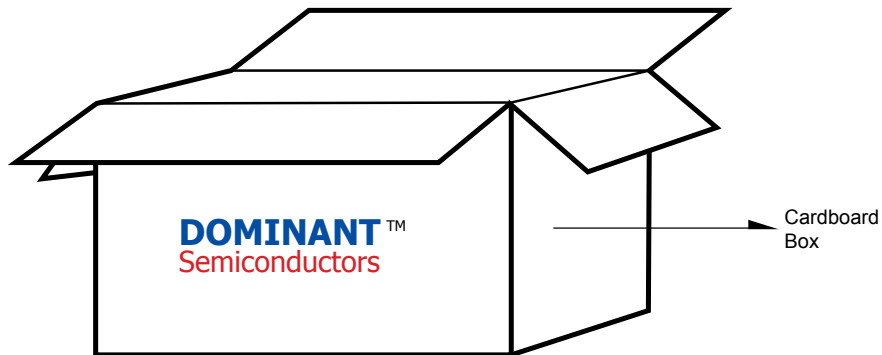

For DomiLED™

Cardboard Box Size	Dimensions (mm)	Empty Box Weight (kg)	Reel / Box	Quantity / Box (pcs)
Small	300 x 250 x 250	0.58	15 reels MAX	30,000 MAX
Large	416 x 516 x 476	1.74	96 reels MAX	192,000 MAX

Recommended Sn-Pb IR-Reflow Soldering Profile

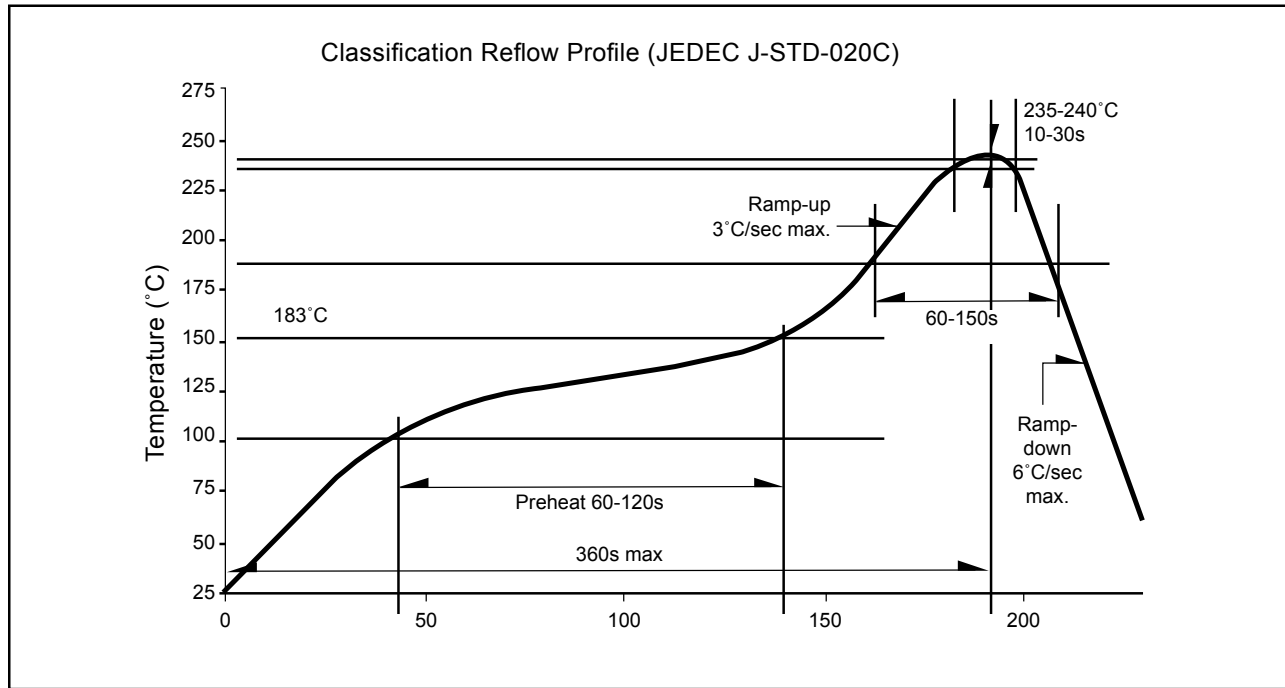

Recommended Pb-free Soldering Profile

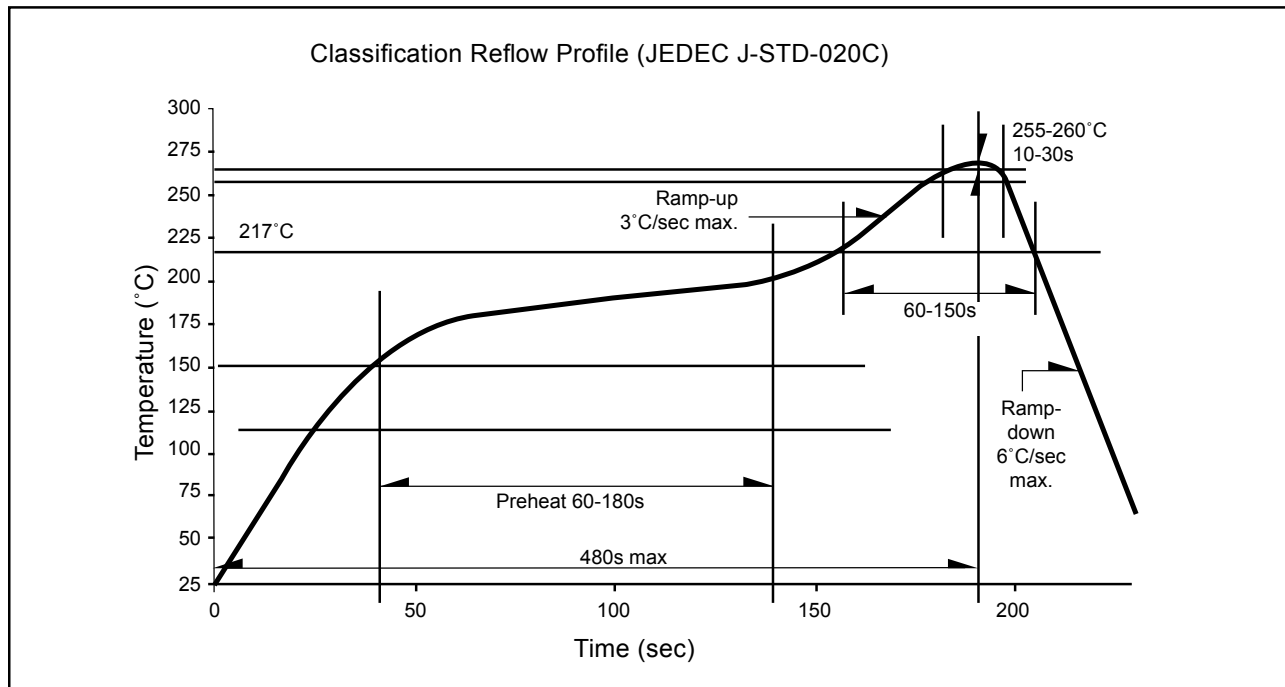

About Us

DOMINANT Semiconductors is a dynamic Malaysian Corporation that is among the world's leading SMT LED Manufacturers. An excellence – driven organization, it offers a comprehensive product range for diverse industries and applications. Featuring an internationally certified quality assurance acclaim, DOMINANT's extra bright LEDs are perfectly suited for various lighting applications in the automotive, consumer and communications as well as industrial sectors. With extensive industry experience and relentless pursuit of innovation, DOMINANT's state-of-art manufacturing, research and testing capabilities have become a trusted and reliable brand across the globe. More information about DOMINANT Semiconductors can be found on the Internet at <http://www.dominant-semi.com>.

Please contact us for more information:

Head Quarter

DOMINANT Semiconductors Sdn. Bhd.
Lot 6, Batu Berendam, FTZ Phase III, 75350 Melaka, Malaysia
Tel: (606) 283 3566 Fax: (606) 283 0566
E-mail: sales@dominant-semi.com

DOMINANT Semiconductors Malaysia Sdn. Bhd. Shanghai Representative Office

DOMINANT Semiconductors (Shenzhen) Co. Ltd.
Rm 1007, DaZhong Building, No. 1515 Zhong Shan (W) Rd, Shanghai, China 200235
Tel: +86 21 6428 6428 Fax: +86 21 6428 6880
E-mail: sales_china@dominant-semi.com

DOMINANT Korea Sales Office

DOMINANT Semiconductors Korea Inc.
#709, Yatap Leaders Bldg., 342-1 Yatap-dong, Bundang-gu, Seongnam-si, Gyeonggi-do, 463-828 Korea.
Tel: +82-31-701-5203 Fax: +82-31-701-5204
E-mail: sales_korea@dominant-semi.com

DOMINANT U.S.A Sales Office

25 Rockaway Road, 08833 Lebanon, New Jersey, USA
Tel: (908) 439-9930 Cell: (908) 343-5810 Fax: (908) 439-9929
E-mail: don.wendel@dominant-semi.com

DOMINANT Europe Sales Office

DOMINANT Semiconductors Europe GmbH
Raiffeisenstr. 38, 74906 Bad Rappenau Germany
Tel: +49 (0) 7264-89010-10 / +49 (0) 7264-89010-11 Cell: +49 173-6907370 / +49 173-6907751
Fax: +49 (0) 7264-89010-29
E-mail: gerd.wachno@dominant-semi.eu; hartmut.wettengl@dominant-semi.eu

DOMINANT India Sales Office

C-11,Vasanth Business Centre #86, TTK Road, Alwarpet Chennai - 600 018, INDIA
Tel: 91-44-42030616 / 516 Cell: 91-9444920537 Fax: 91-9444920616
E-mail: pravat.behera@dominant-semi.com



DOMINANT™
Semiconductors
Innovating Illumination