

Features

- 5 Bits, 0.5 dB Steps
- Excellent Accuracy
- Single Positive Control (+3 V to +5 V)
- Lead-Free MSOP-10 Package
- 100% Matte Tin Plating over Copper
- Halogen-Free "Green" Mold Compound
- RoHS* Compliant and 260°C Reflow Compatible

Description

M/A-COM's MAATSS0022 is a 0.5 dB step GaAs MMIC digital attenuator with 15.5 dB attenuation range in a lead-free MSOP-10 package. It requires external DC blocking capacitors on the RF ports, positive supply voltage and five individual bit control voltages.

The MAATSS0022 is particularly suited where high attenuation accuracy, low insertion loss and low intermodulation products are required. Typical applications include base stations, wireless data, and wireless local loop gain level control circuits.

The MAATSS0022 is fabricated using M/A-COM's GaAs 1.0 micron process. The process features full chip passivation for increased performance and reliability.

Recommended Configuration

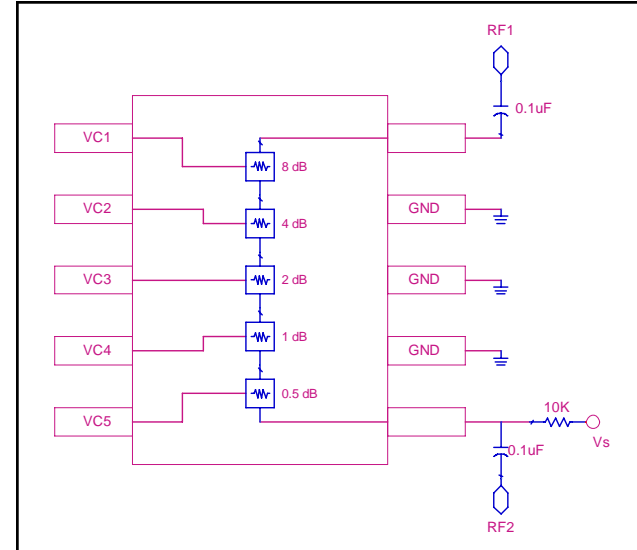

Pin Configuration

Pin No.	Function	Pin No.	Function
1	VC1	6	RF Port 2
2	VC2	7	Ground
3	VC3	8	Ground
4	VC4	9	Ground
5	VC5	10	RF Port 1

Ordering Information ¹

Part Number	Package
MAATSS0022	Bulk Packaging
MAATSS0022TR-3000	3000 piece reel
MAATSS0022SMB	Sample Test Board

1. Reference Application Note M513 for reel size information.

Absolute Maximum Ratings ^{2,3}

Parameter	Absolute Maximum
Input Power	+34 dBm
Voltage	+7 V
Operating Temperature	-40°C to +85°C
Storage Temperature	-65°C to +125°C

2. Exceeding any one or combination of these limits may cause permanent damage to this device.
3. M/A-COM does not recommend sustained operation near these survivability limits.

* Restrictions on Hazardous Substances, European Union Directive 2002/95/EC.

Electrical Specifications: $T_A = 25\text{ }^\circ\text{C}$, $Z_0 = 50\ \Omega$, $V_S = +5\text{ V}$, $V_C = 0\text{ V} / 5\text{ V}$

Parameter	Conditions	Frequency	Units	Min.	Typ.	Max.
Insertion Loss (reference state)	—	0.5 - 0.8 GHz	dB	—	1.45	—
		0.8 - 1.8 GHz	dB	—	1.75	—
		1.8 - 2.2 GHz	dB	—	2.05	—
		2.1 GHz	dB	—	2.1	2.5
		2.2 - 2.5 GHz	dB	—	2.2	—
VSWR	Any State	0.5 - 2.5 GHz	Ratio	—	1.6:1	—
Accuracy	Any State	0.5 - 0.8 GHz	dB	± (0.3 + 4% atten setting) Typical		
		0.8 - 1.8 GHz	dB	± (0.3 + 3% atten setting) Typical		
		1.8 - 2.2 GHz	dB	± (0.3 + 6% atten setting) Typical		
		2.1 GHz	dB	± (0.3 + 6% atten setting) Min / Max		
		2.2 - 2.5 GHz	dB	± (0.3 + 8% atten setting) Typical		
Attenuation Range	—	0.5 - 2.5 GHz	dB	—	15.5	—
1 dB Compression Input Power	+3 V +5 V	0.5 - 2.5 GHz	dBm	—	25	—
		0.5 - 2.5 GHz	dBm	—	30	—
IP3	Two tones, $P_{in} \leq +5\text{ dBm} / \text{tone}$ +3 V +5 V	0.5 - 2.5 GHz	dBm	—	36	—
		0.5 - 2.5 GHz	dBm	—	46	—
Trise, Tfall	10/90% or 90/10% RF	—	µS	—	2	—
Ton, Toff	50% CNTL to 90/10% RF	—	µS	—	2	—
Transients	In Band	—	mV	—	62	—
Supply Current	+3 V +5 V	—	µA	—	5	40
		—	µA	—	5	40
Total Control Current	+3 V +5 V	—	µA	—	—	100
		—	µA	—	—	100

Truth Table ⁴

Control Inputs					
VC5	VC4	VC3	VC2	VC1	Attenuation (dB)
1	1	1	1	1	Reference
0	1	1	1	1	0.5 dB
1	0	1	1	1	1 dB
1	1	0	1	1	2 dB
1	1	1	0	1	4 dB
1	1	1	1	0	8 dB
0	0	0	0	0	15.5 dB

4. 0 = 0.0 V ± 0.2 V, 1 = $V_S = 5.0\text{ V} \pm 0.2\text{ V}$.

Operating Instructions

The MAATSS0022 is designed to operate with 5 V logic levels. The difference between +3 V and +5 V operation is minimal for small signal performance. IIP3, however, is a strong function of voltage. +3 V is the minimum voltage at which the product will reliably operate.

The MAATSS0022 requires a parallel interface that allows the user to enter a 5 bit digital word. Each state increments the attenuation by 0.5 dB giving a total range of 15.5 dB.

The MAATSS0022 is not internally DC blocked. This means that the device requires DC blocking capacitors on the RF1 and RF2 ports. M/A-COM recommends 0.1 µF to allow for the entire frequency range to be utilized. Higher frequency applications can use smaller value capacitors as DC blocks.

Typical Performance Curves @ +5 V

Attenuation, All Major States

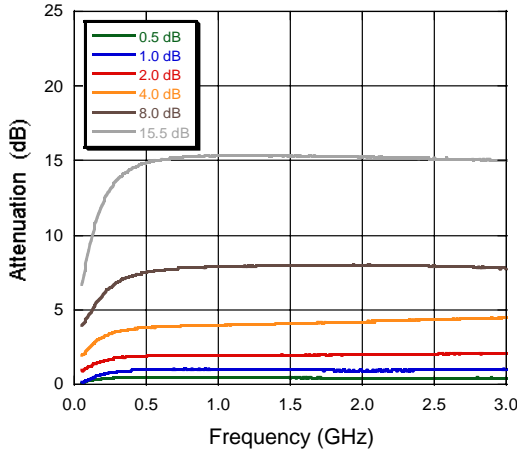

Insertion Loss

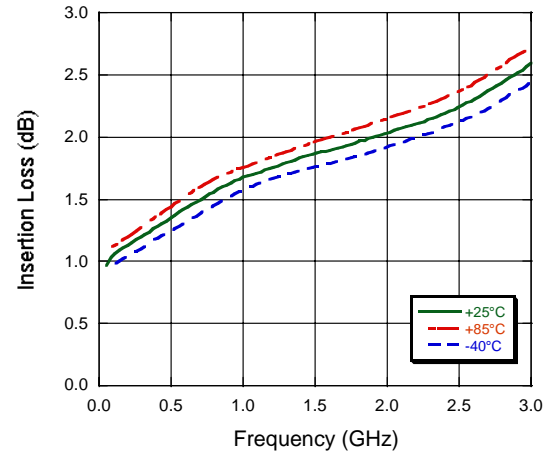

Input Return Loss at Insertion Loss State

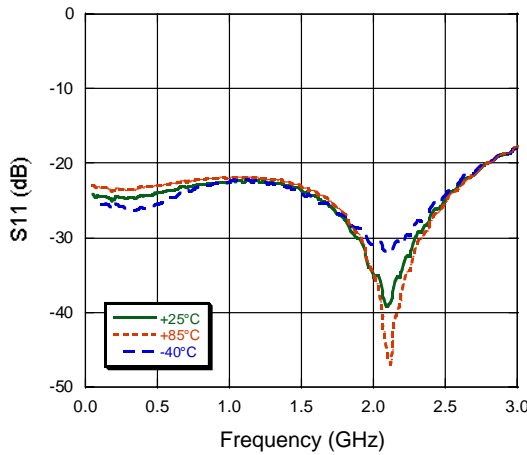

Output Return Loss at Insertion Loss State

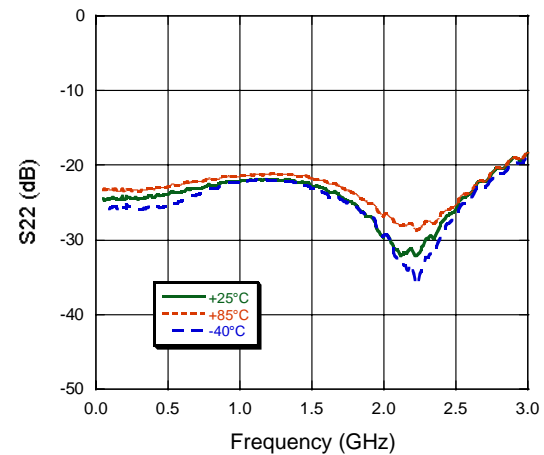

Input IP3 at Insertion Loss State

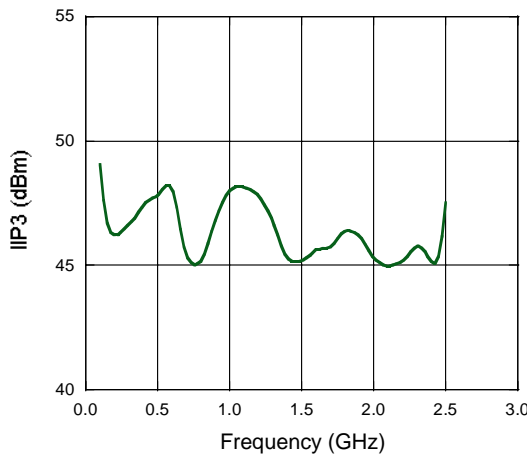

Digital Attenuator, 5-Bit, 15.5 dB
500 - 2500 MHz

MAATSS0022
V2

Lead-Free MSOP-10[†]

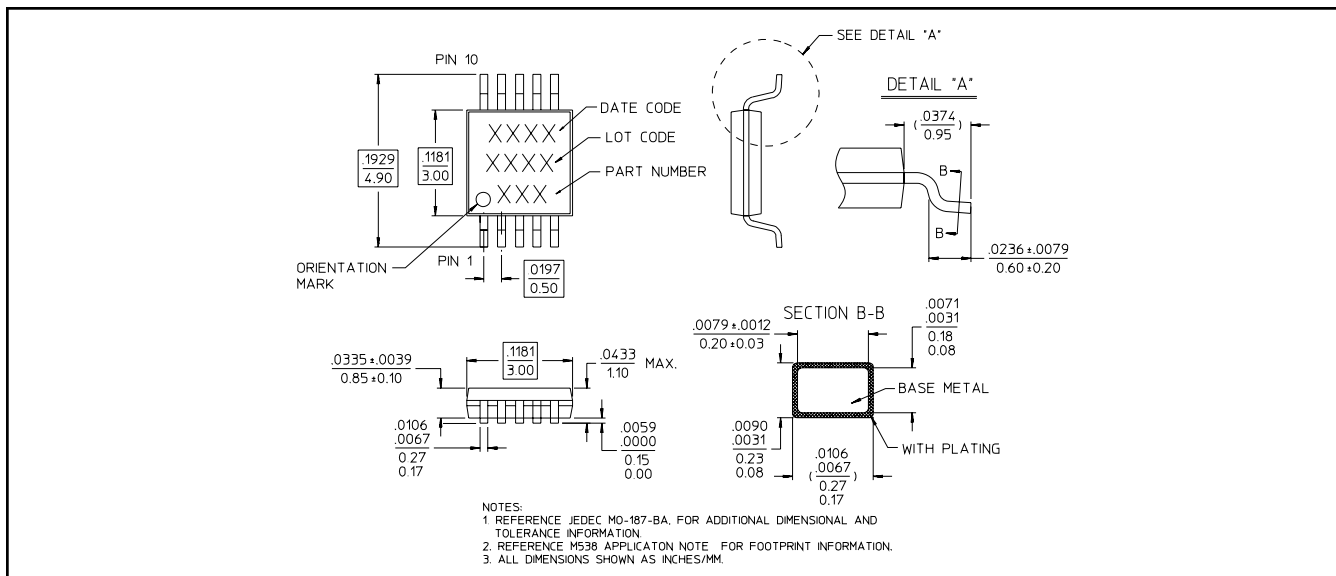

[†] Reference Application Note M538 for lead-free solder reflow recommendations.
Meets JEDEC moisture sensitivity level 1 requirements.

Handling Procedures

Please observe the following precautions to avoid damage:

Static Sensitivity

Gallium Arsenide Integrated Circuits are sensitive to electrostatic discharge (ESD) and can be damaged by static electricity. Proper ESD control techniques should be used when handling these devices.