

**Digital Attenuator, 1-Bit, 10 dB Step
DC - 2.0 GHz**

**MAATSS0018
V2**

Features

- Single 10 dB Step
- Low Loss: 0.3 dB @ 900 MHz
- Lead-Free SOT-25 Package
- 100% Matte Tin Plating over Copper
- Halogen-Free "Green" Mold Compound
- 260°C Reflow Compatible
- RoHS* Compliant Version of AT-266

Description

M/A-COM's MAATSS0018 is a 1 bit, 10 dB step GaAs MMIC digital attenuator in a lead-free SOT-25 surface mount plastic package. The MAATSS0018 is ideally suited for use where high accuracy, very low power consumption and low intermodulation products are required. Typical applications include radio, wireless LANs, GPS equipment and other gain/level control circuits.

The MAATSS0018 is a GaAs MMIC using a mature 1-micron process. The process features full chip passivation for increased performance and reliability.

Ordering Information

Part Number	Package
MAATSS0018	Bulk Packaging
MAATSS0018TR	1000 piece reel

Note: Reference Application Note M513 for reel size information.

Absolute Maximum Ratings ^{1,2}

Parameter	Absolute Maximum
Input Power 50 MHz 500 - 2000 MHz	+27 dBm +34 dBm
Control Voltage	$-8.5\text{ V} \leq V_c \leq +8\text{ V}$
Operating Temperature	-40°C to +85°C
Storing Temperature	-65°C to +150°C

1. Exceeding any one or combination of these limits may cause permanent damage to this device.
2. M/A-COM does not recommend sustained operation near these survivability limits.

* Restrictions on Hazardous Substances, European Union Directive 2002/95/EC.

Functional Block Diagram

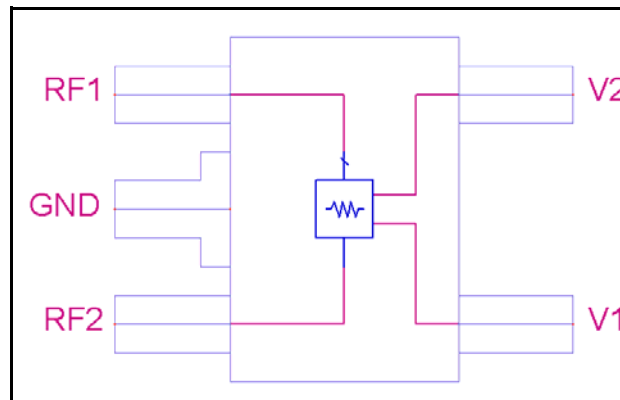

Pin Configuration

Pin No.	Function	Description
1	RF1	RF In/Out
2	GND	RF Ground
3	RF2	RF In/Out
4	V1	Control Voltage
5	V2	Control Voltage

Truth Table ^{3,4,5}

V1	V2	Attenuation State
0	1	10 dB
1	0	Insertion Loss

3. For positive voltage control, external DC blocking capacitors are required on all RF ports (pins 1, 2 and 3)
4. Differential voltage, $V(\text{state } 1) - V(\text{state } 0)$, must be +2.8 V minimum and less than 8 V.
5. 0 = -8 V to 0.2 V, 1 = -0.2 V to 8 V

**Digital Attenuator, 1-Bit, 10 dB Step
DC - 2.0 GHz**

**MAATSS0018
V2**

Electrical Specifications: $T_A = 25^\circ\text{C}$, $V_C = 0\text{ V} / -3\text{ V}$, $Z_0 = 50\ \Omega$

Parameter	Test Conditions	Units	Min.	Typ.	Max.
Insertion Loss	0 - 1 GHz	dB	—	0.3	0.45
	1 - 2 GHz	dB	—	0.5	0.7
Attenuation	DC - 2 GHz	dB	9.5	10	10.5
VSWR	0 - 2 GHz	Ratio	—	1.4:1	—
IP ₃	2 Tone @ 0 dBm, 5 MHz spacing	dBm	—	50	—
P1dB	1 GHz	dBm	—	28	—
Trise, Tfall	10% to 90% RF, 90% to 10% RF	nS	—	5	—
Ton, Toff	50% Control to 90% RF, 50% Control to 10% RF	nS	—	10	—
Transients	In Band	mV	—	6	—
Control Current	$ V_C = 3\text{ V}$	μA	—	25	—

Lead-Free SOT-25[†]

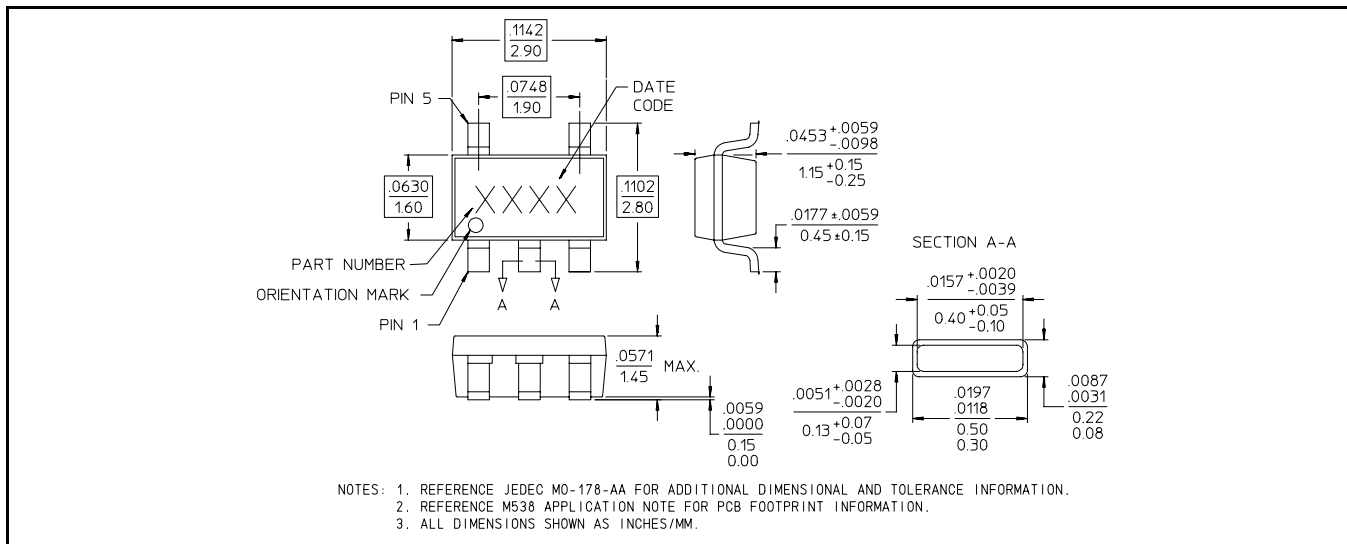

[†] Reference Application Note M538 for lead-free solder reflow recommendations.

Handling Procedures

Please observe the following precautions to avoid damage:

Static Sensitivity

Gallium Arsenide Integrated Circuits are sensitive to electrostatic discharge (ESD) and can be damaged by static electricity. Proper ESD control techniques should be used when handling these devices.

**Digital Attenuator, 1-Bit, 10 dB Step
DC - 2.0 GHz**

**MAATSS0018
V2**

Typical Performance Curves (39 pF capacitors used for positive voltage control)

Insertion Loss (Positive Control)

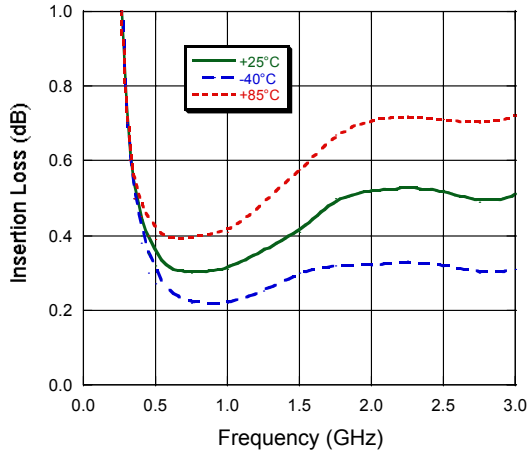

Insertion Loss (Negative Control)

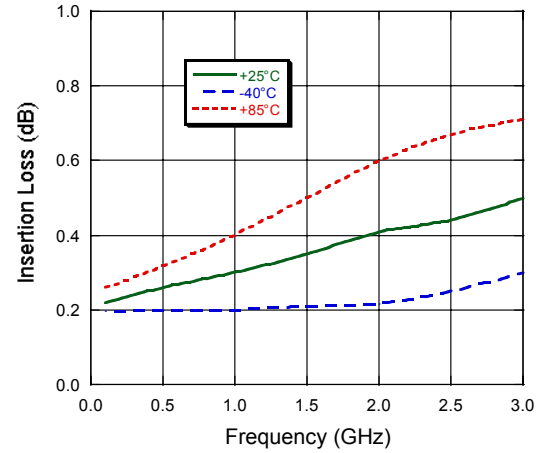

Relative Attenuation (Positive Control)

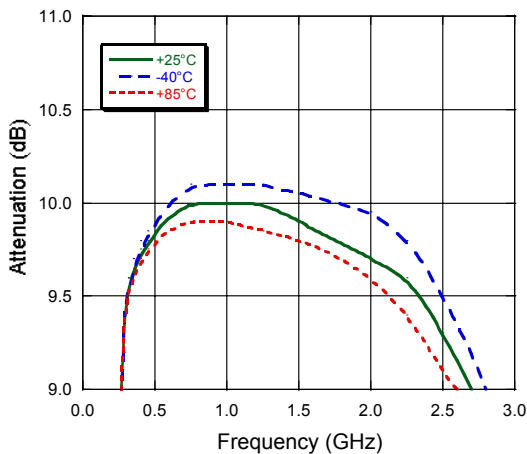

Relative Attenuation (Negative Control)

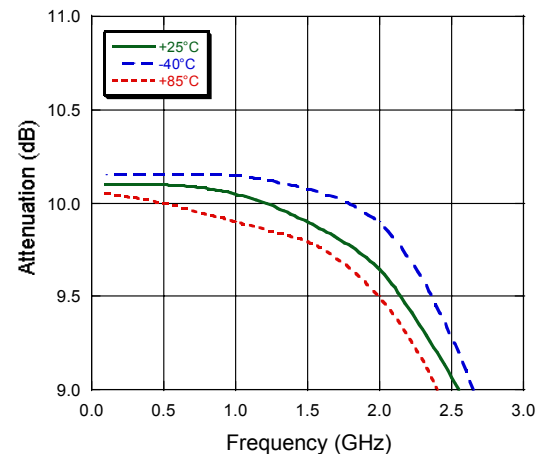

Return Loss (Reference State)

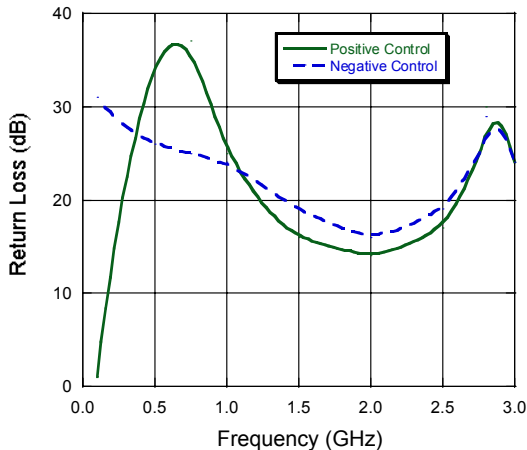

Return Loss (10 dB State)

