



UAA1016B

Zero Voltage Controller

The UAA1016B is designed to drive triacs with the Zero Voltage technique which allows RFI free power regulation of resistive loads. It provides the following features:

4

- Proportional Temperature Control Over an Adjustable Band
- Adjustable Burst Frequency (to Comply with Standards)
- No DC Current Component Through the Main Line (to Comply with Standards)
- Negative Output Current Pulses (Triac Quadrants 2 and 3)
- Direct AC Line Operation
- Low External Components Count

ZERO VOLTAGE SWITCH PROPORTIONAL BAND TEMPERATURE CONTROLLER

SEMICONDUCTOR
TECHNICAL DATA

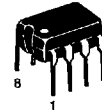

PLASTIC PACKAGE
CASE 626

ORDERING INFORMATION

Device	Operating Temperature Range	Package
UAA1016B	T _A = -20° to +100°C	Plastic DIP

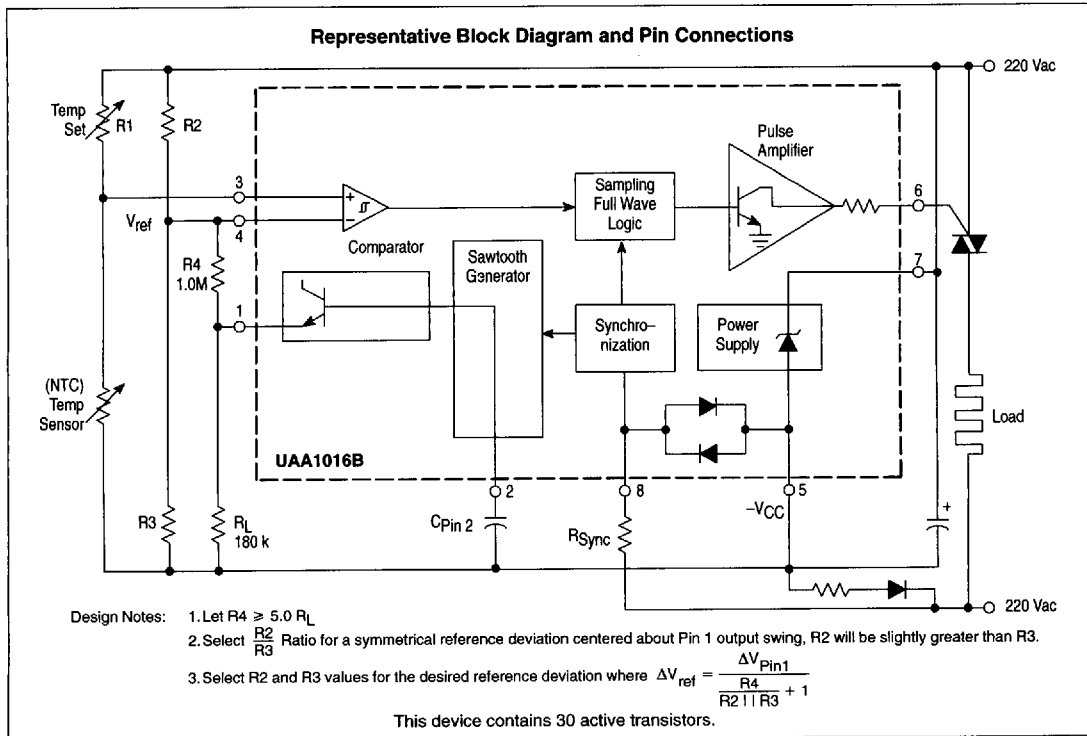

UAA1016B

MAXIMUM RATINGS (Voltages Referred to Pin 7)

Parameter	Symbol	Max. Rating	Unit
Supply Current ($I_{Pin 5}$)	I_{CC}	15	mA
Nonrepetitive Supply Current ($I_{Pin 5}$)	I_{CCP}	200	mA
AC Synchronization Current (Pin 8)	I_{syn}	3.0	mArms
Maximum Pin Voltages	$V_{Pin 1}$ $V_{Pin 2}$ $V_{Pin 3}$ $V_{Pin 4}$ $V_{Pin 6}$	0; $-V_{CC}$ 0; $-V_{CC}$ 0; $-V_{CC}$ 0; $-V_{CC}$ 2.0; $-V_{CC}$	V
Maximum Current Drain	$I_{Pin 1}$	1.0	mA
Power Dissipation $T_A = 25^\circ\text{C}$	P_D	625	mW
Maximum Thermal Resistance	$R_{\theta JA}$	100	$^\circ\text{C/W}$
Operating Temperature Range	T_A	-20 to +100	$^\circ\text{C}$

NOTE: ESD data available upon request.

ELECTRICAL CHARACTERISTICS ($T_A = 25^\circ\text{C}$, Voltages Referred to Pin 7, unless otherwise noted.)

Characteristics	Symbol	Min	Typ	Max	Unit
Current Consumption (Pins 6 and 8 not connected)	I_{CC}	-	0.8	1.5	mA
Stabilized Supply Voltage ($V_{Pin 5}$) $I_{CC} = 2.0$ mA max	$-V_{CC}$	-9.6	-8.6	-7.6	V
Output Pulse Current ($V_{Pin 6}$ from -1.0 to +1.0 V)	I_{out}	60	90	120	mA
Output Pulse Width $R_{Pin 8} = 220$ k Ω , $V_{mains} = 220$ Vac/50 Hz, (Figures 3 and 4)	t_{p1} t_{p2}	58 160	60 220	120 320	μs
Comparator Input Offset Voltage ($V_{Pin 3} - V_{Pin 4}$)	V_{off}	-10	-	10	mV
Comparator Common Mode Voltage Range	V_{CM}	$-V_{CC} + 1$	-	-1.5	V
Input Bias Current (Pins 3 and 4)	I_{IB}	-	-	1.0	μA
Output Leakage Current ($I_{Pin 6}$) $V_{Pin 6} = +2.0$ V	I_{outL}	-	-	10	μA
Capacitor Charging Current (Source)	$I_{Pin 2}$	-20	-16	-12	μA
Capacitor Discharge Current (Sink)	$I'_{Pin 2}$	-	6.4	-	mA
Sawtooth Pulse Length ($C_{Pin 2} = 1.0$ μF)	t_{saw}	-	0.85	-	S
Output Threshold Sawtooth Levels ($V_{Pin 2}$)	V_{TH1} V_{TH2}	-	-1.0 $-V_{CC} + 1.25$	-	V
Output Voltage Pin 1	$V_{Pin 1}$	-	$V_{Pin 2} - 0.75$	-	V

CIRCUIT DESCRIPTION

The circuit delivers current pulses to the triac at zero crossings of the main line sensed by Pin 8 through R_{sync} . An internal full wave logic allows the triac to latch during full wave periods in order to avoid any dc component in the main line, in compliance with European regulations. Trigger pulses are generated when the comparator detects $V_{Pin 3}$ is above $V_{Pin 4}$ (or $V_{reference}$) as sensed temperature through the NTC is then lower than the set value (V_{ref} corresponding to the external Wheatstone bridge equilibrium).

In order to comply with norms limiting the frequency at which a kW sized load, or above, may be connected to the main line (fluorescent tubes "flickering"), the UAA1016B has

an internal time base providing (power is delivered by bursts to the load) a proportional temperature band control. In fact, most of the heating regulation systems require low temperature overshoot for more precision and stability which cannot be accomplished by direct on/off regulation (see Figure 1). An internal low frequency sawtooth generator whose output is available at Pin 1, allows the designer to introduce a periodic linear change of V_{ref} . This deviation defines the temperature band allowing proportional power control (see Figure 2).

The IC is directly powered from the mains by a dropping resistor, a diode and a filter capacitor.

6367253 0101639 3T4

UAA1016B

Figure 1. Proportional Temperature Control versus On/Off Control

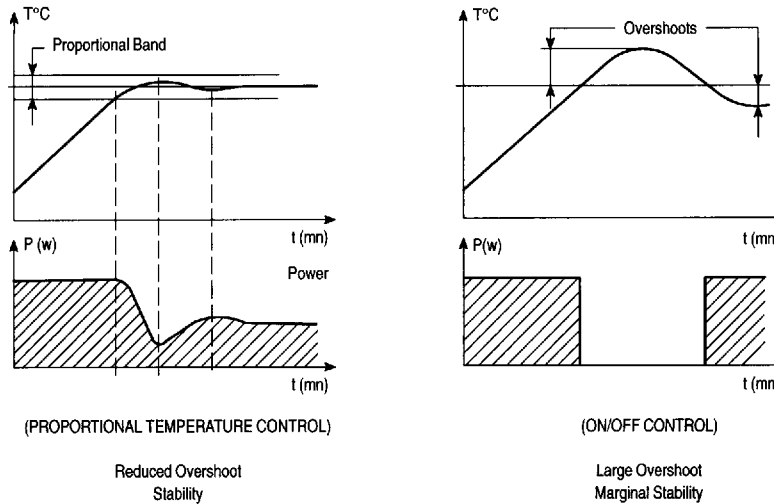

KEY CIRCUIT FUNCTIONS DESCRIPTION

Power Supply

The rectified supply current is Zener regulated to 8.6 V. Current consumption of the UAA1016B is typically less than 1.0 mA. The major part of the current fed by the dropping resistor is used for the sensor bridge and triac gate pulses. Any excess of supply current is excess power dissipation into the integrated Zener. Current consumption of the triac pulses may be derived from Figure 3 and 4 (lgt maximum and pulse duration). Usually an 18 k Ω , 2.0 W dropping resistor is convenient to feed the UAA1016.

Comparator

When $V_{P_{in 3}}$ is higher than $V_{P_{in 4}}$ (V_{ref}), the comparator allows the triggering logic to deliver pulses to the triac (Figure 2). The offset hysteresis input voltage has been designed to be as low as possible (± 10 mV maximum) in order to minimize the uncontrollable temperature band (proportional to the hysteresis) as per Figure 5. Noise rejection is performed by a synchronous sampling of the comparator output during very short times (typical less than 100 ns).

Sawtooth Generator

A sawtooth voltage signal is generated by a constant current source (typical 7.5 μ A), charging an external capacitor $C_{P_{in 2}}$ between two threshold levels, V_{TH1} and V_{TH2} , which are respectively:

$$V_{TH1} = -1.0 \text{ V}$$

$$V_{TH2} = -V_{CC} + 1.25 \text{ V}$$

Charging and discharging currents occur only with negative halfcycles of the line. In the UAA1016B, the sawtooth signal is available at Pin 1 as a voltage source $V_{P_{in 1}} = V_{P_{in 2}} - 0.75 \text{ V}$. Maximum source current is 1.0 mA, but to keep good linearity of sawtooth signal, a source current of 40 μ A is recommended (see Figure 6).

Sampling Full Wave Logic

Two consecutive zero-crossing trigger pulses are generated at every positive mains half-cycle of the line to minimize generation of noise (as per Figure 7). Within every zero-crossing the pulses are positioned as per Figure 3. Pulse length is also adjustable by R_{sync} on Pin 8 to allow positive triggering of the triac at this critical moment (firing with low voltage between main terminals requires long pulses).

Pulse Amplifier

The pulse amplifier circuit delivers minimum current pulses of 60 mA (sink). The triac is triggered in quadrants II and III.

Synchronization Circuit

This circuit detects mains zero-crossings through R_{sync} and the value selected determines the trigger pulse length. A zero crossing current detector is employed with typical thresholds of $\pm 27 \mu$ A to $\pm 98 \mu$ A (see Figures 3 and 4).

6367253 0101640 016

UAA1016B

Figure 2. Sawtooth Generator and Proportional Band

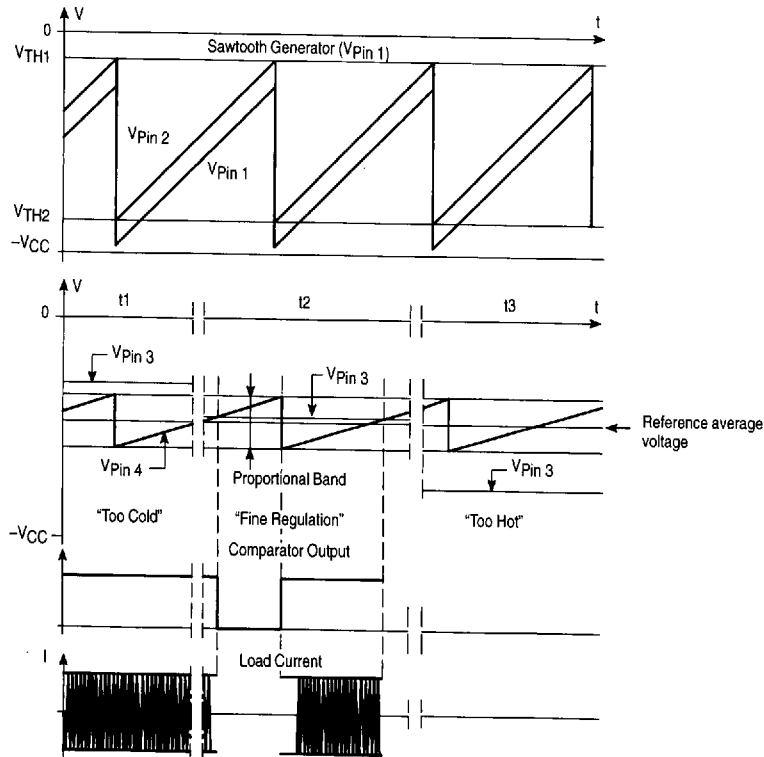

4

COMMENTS TO FIGURE 2

Referring to Figure 1, the average value of V_{ref} is set by R2 and R3. R4 defines the amplitude of the sawtooth signal superimposed on V_{ref} , defining the Proportional Band.

Figure 2 shows three conditions:

1) During time t1 we always have $V_{Pin\ 3} > V_{ref}$, and as a result, the comparator is always "on" and the triac fired (100% maximum power)

2) During time t2, $V_{Pin\ 3}$ is in the proportional band, and the average power delivered to the load is a fraction of maximum power.

3) During time t3, $V_{Pin\ 3} < V_{ref}$, and the triac is always "off." When the sensor temperature is above the set value and is slowly decreasing as no heating occurs, $V_{Pin\ 3} - V_{Pin\ 4}$ must exceed half the hysteresis value before power is applied again (1). A similar effect occurs in the opposite direction when temperature sensor is below the set value and can remain stable as position (2). This defines the

"uncontrollable temperature band" which will be very small if hysteresis is also very small.

SUGGESTIONS FOR USE

The temperature sensor circuit is a Wheatstone bridge including the sensor element. Comparator inputs may be free from power line noise only if the sensor element is purely resistive (NTC resistor). Usage of any P-N junction sensor would drastically reduce noise rejection.

Fixed phase sensing of the internal comparator output eliminates parasitic signals.

Some loads, even designed to be resistive, have in fact a slight inductive component. A phase shift at Pin 8 can be achieved with external capacitor C3 connected to Pin 8 network (see Figure 8).

Suggested maximum source current at Pin 1 is 40 μ A, in order to have acceptable sawtooth signal linearity.

6367253 0101641 T52

MOTOROLA ANALOG IC DEVICE DATA

4-119

UAA1016B

Figure 3. Output Pulse Width Definitions

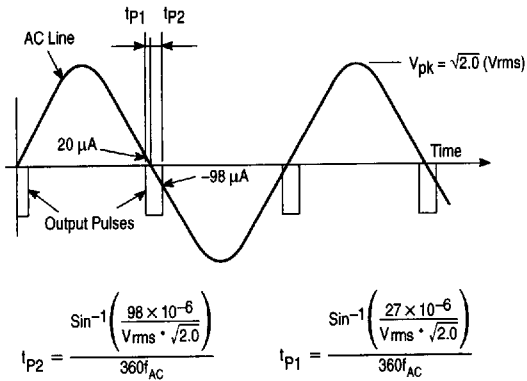

4

Figure 4. Typical Output Pulse Length versus Synchronization Resistor

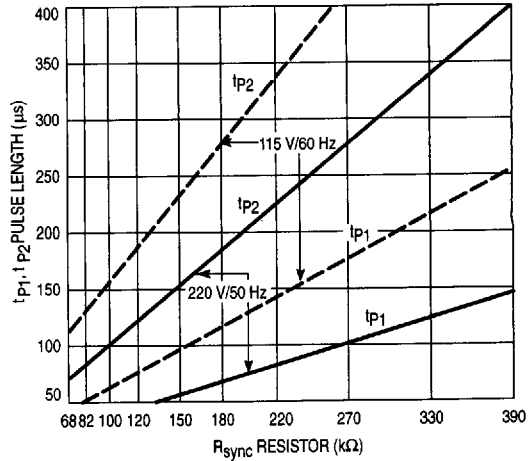

Figure 5. Effects of Inputs Comparator Hysteresis

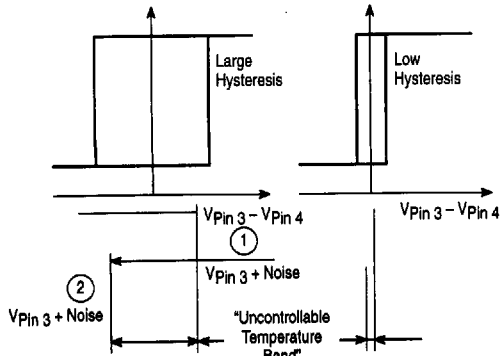

Figure 6. Pin 1 Internal Network

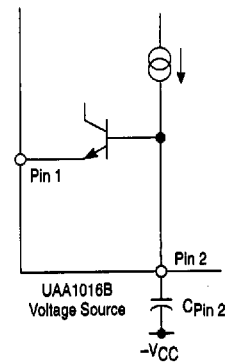
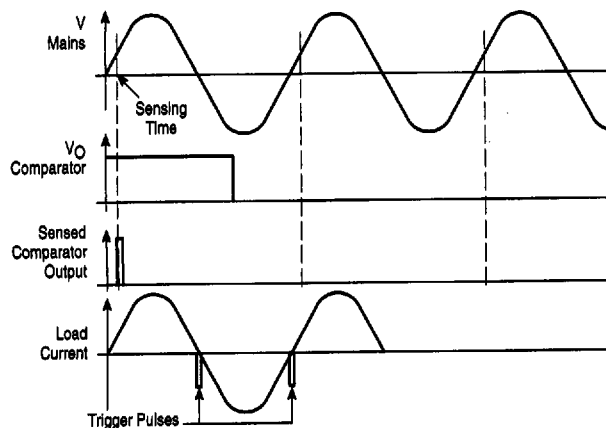

Figure 7. Trigger Pulse Generation



UAA1016B

APPLICATION CIRCUITS

Figure 8 shows a very simple application of the UAA1016B as an electronic rheostat having 100% efficiency. C3 is required only if load has an inductive component. Figure 9

shows a typical application as a panel heater thermostat with a proportional temperature band of 1.0°C at 25°C.

Figure 8. Electronic Rheostat

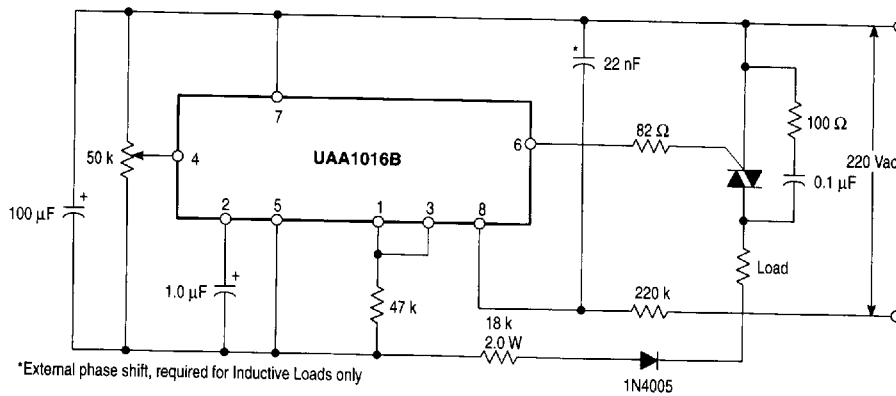

4

Figure 9. Application Circuit—Electric Radiator with Proportional Band Thermostat
(Proportional Band 1°C at 25°C)

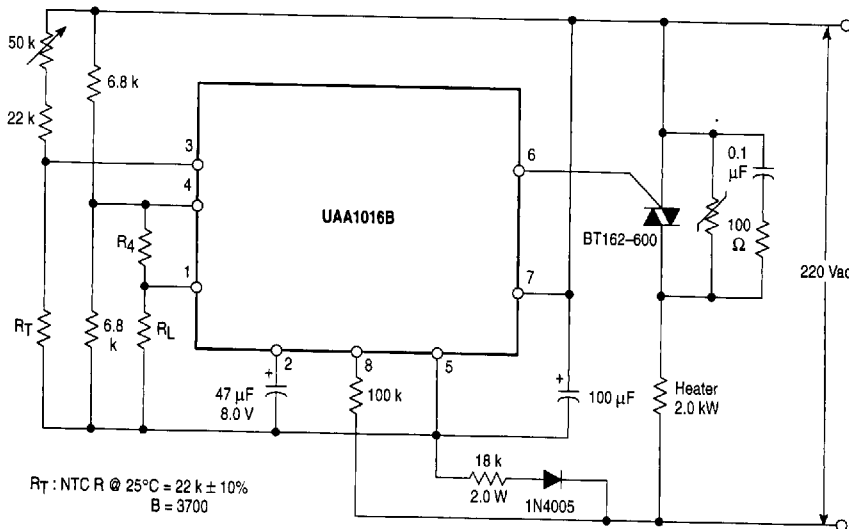

6367253 0101643 825

MOTOROLA ANALOG IC DEVICE DATA

4-121