

Schematic:

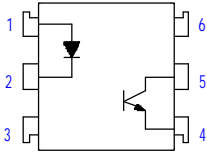

For dimensions and pin-outs, see the last page of this document.

Features:

1. Current transfer ratio
(CTR : MIN.40% at IF=10mA Vce=5V)
2. High isolation voltage between input and output
(Viso : 5300Vrms).

Ordering:

Suffix to Standard Part Number

- V = VDE Compliant
- G = 10mm Lead Spread
- S = Surface Mount Lead-form
- T = Tape & Reel

Equivalents:

This part equals/ exceeds all specifications of:

- CNX62A, 82A
- CNY17F-1, 2, 3, 4
- MOC8101, 2, 3, 4
- MOC8106, 7, 8
- MOC8111, 12, 13

Absolute Maximum Ratings:

Parameter		Symbol	Rating	Unit
Input	Forward current	IF	50	mA
	Peak forward current	IFM	1	A
	Reverse voltage	VR	6	V
	Power dissipation	PD	70	mW
Output	Collector-emitter voltage	VCEO	60	V
	Emitter-collector voltage	VECO	6	V
	Collector current	IC	50	mA
	Collector power dissipation	PC	150	mW
Total power dissipation		Ptot	200	mW
Isolation voltage 1 minute		Viso	5300	Vrms
Operating temperature		Topr	-55 to +100	°C
Storage temperature		Tstg	-55 to +125	°C
Soldering temperature 10 second		Tsol	260	°C

Electrical Characteristics:

Parameter		Symbol	Conditions	MIN.	TYP.	MAX.	Unit
Input	Forward voltage	VF	IF=20mA	–	1.2	1.4	V
	Peak forward voltage	VFM	IFM=0.5A	–	–	3.5	V
	Reverse current	IR	VR=4V	–	–	10	uA
	Terminal capacitance	Ct	V=0, f=1kHz	–	30	–	pF
Output	Collector dark current	ICEO	VCE=20V	–	–	0.1	uA
Transfer characteristics	Current transfer ratio	CTR	IF=10mA, VCE=5V	40	–	320	%
	Collector-emitter saturation voltage	VCE(sat)	IF=20mA, IC=1mA	–	0.1	0.3	V
	Isolation resistance	Riso	DC500V	5x10 ¹⁰	10 ¹¹	–	ohm
	Floating capacitance	Cf	V=0, f=1MHz	–	0.6	1.0	pF
	Cut-off frequency	fc	Vcc=5V, IC=2mA, RL=100ohm	–	80	–	kHz
	Response time (Rise)	tr	Vce=2V, IC=2mA, RL=100ohm	–	5	20	us
Response time (Fall)	tf	–		4	20	us	

Fig. 1 Current Transfer Ratio Vs. Forward Current

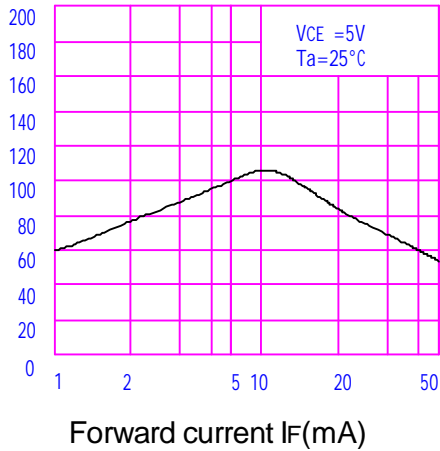

Classification table of current transfer ratio is shown below.

CTR Rank	CTR(%)
A/1	40 TO 80
B/2	63 TO 125
C/3	100 TO 200
D/4	160 TO 320
E/1	50 TO 80
F/2	73 TO 117
G/3	108 TO 173
H/4	160 TO 256

Fig.2 Collector Power Dissipation vs. Ambient Temperature

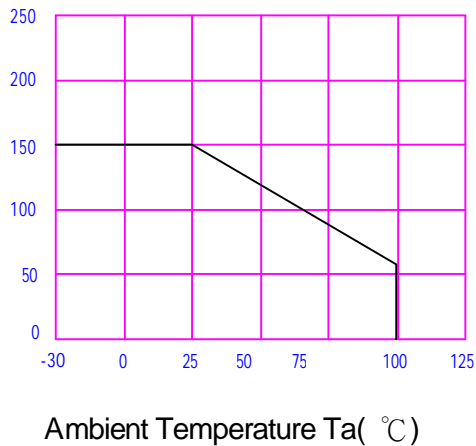

Fig.3 Collector Dark Current vs. Ambient Temperature

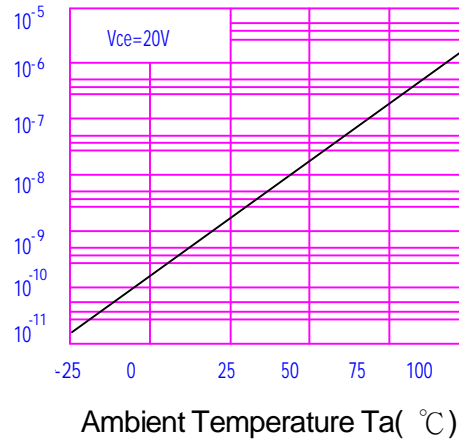

Fig.4 Forward Current vs. Ambient Temperature

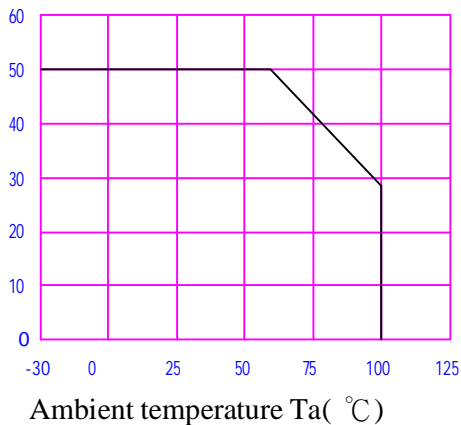

Fig.5 Forward Current vs. Forward Voltage

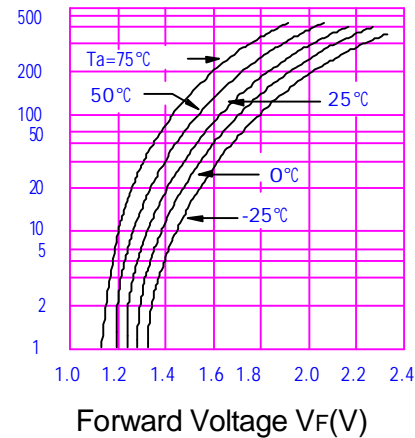

Fig.6 Collector Current vs. Collector-emitter Voltage

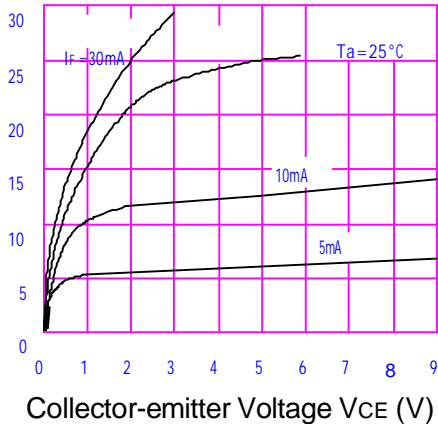

Fig.7 Relative Current Transfer Ratio vs. Ambient Temperature

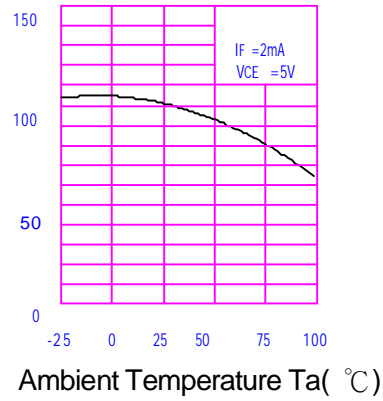

Fig.8 Collector-emitter Saturation Voltage vs. Ambient Temperature

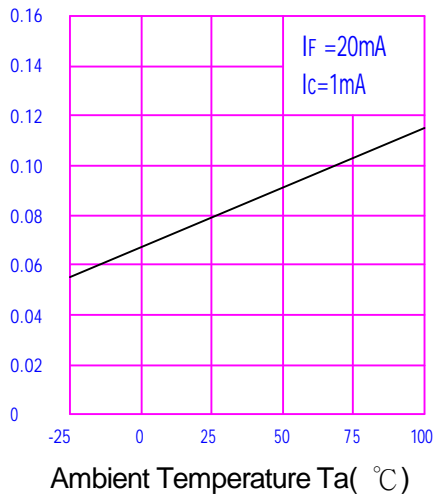

Fig.9 Collector-emitter Saturation Voltage vs. Forward Current

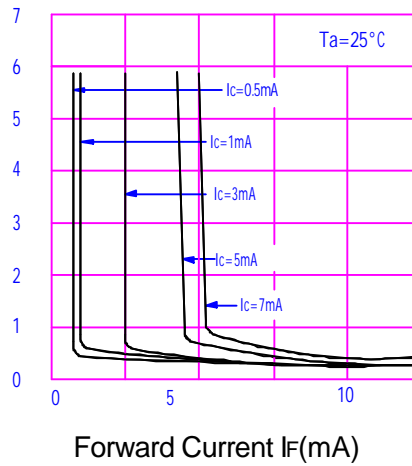

Fig.10 Response Time vs. Load Resistance

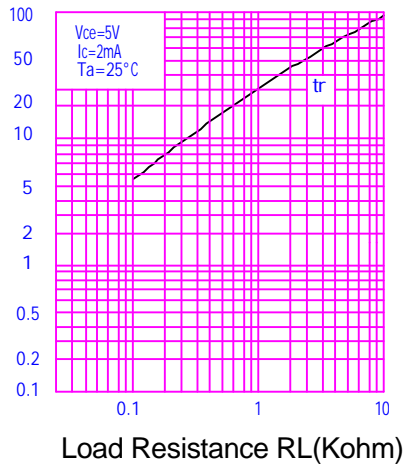

Fig.11 Response Time vs. Load Resistance

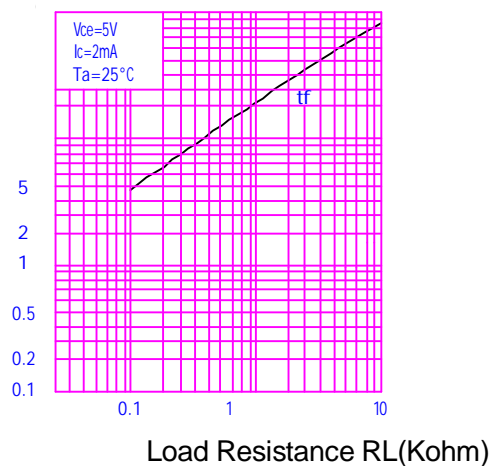

Fig.4 : 6-pin DIP type

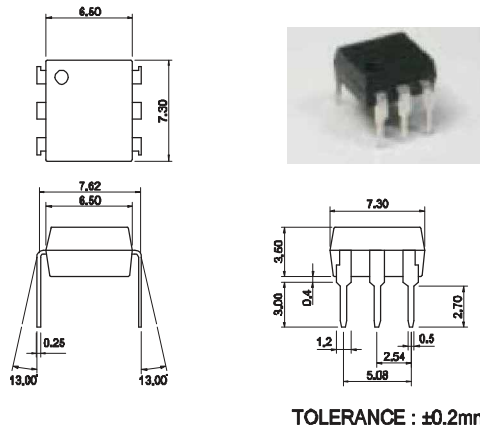

Fig.5 : 6-pin SMD type

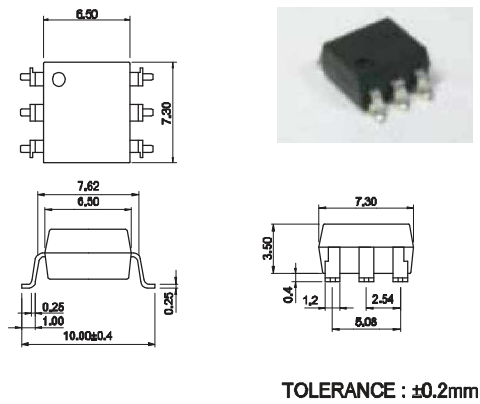

Fig.6 : 6-pin G type

