

Part Number: PSA12-11YWA

YELLOW

Features

- 1.2 INCH CHARACTER HEIGHT .
- LOW CURRENT OPERATION.
- HIGH CONTRAST AND LIGHT OUTPUT.
- EASY MOUNTING ON P.C. BOARDS OR SOCKETS.
- CATEGORIZED FOR LUMINOUS INTENSITY.
- MECHANICALLY RUGGED.
- STANDARD: GRAY FACE, WHITE SEGMENT.
- RoHS COMPLIANT.

Description

The Yellow source color devices are made with Gallium Arsenide Phosphide on Gallium Phosphide Yellow Light Emitting Diode.

Package Dimensions & Internal Circuit Diagram

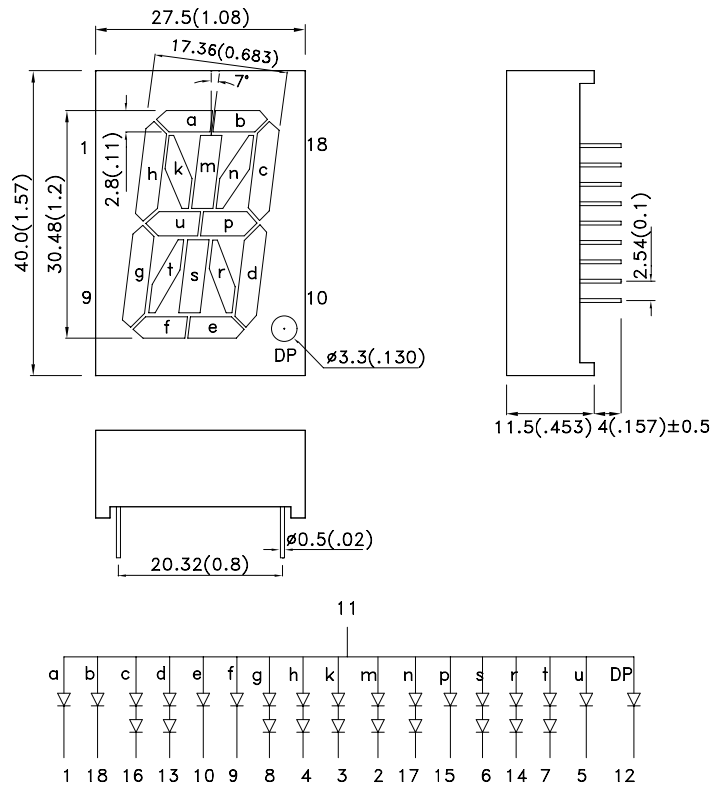

Notes:

1. All dimensions are in millimeters (inches), Tolerance is $\pm 0.25(0.01)$ unless otherwise noted.
2. Specifications are subject to change without notice.



Selection Guide

Part No.	Dice	Lens Type	Iv (ucd) [1] @ 10mA		Description
			Min.	Typ.	
PSA12-11YWA	YELLOW (GaAsP/GaP)	WHITE DIFFUSED	1200	4700	Common Anode, Rt. Hand Decimal

Note:

1. Luminous Intensity/ Luminous Flux: +/-15%.

Electrical / Optical Characteristics at TA=25°C

Symbol	Parameter	Device	Typ.	Max.	Units	Test Conditions
λ_{peak}	Peak Wavelength	Yellow	590		nm	IF=20mA
$\lambda_D[1]$	Dominant Wavelength	Yellow	588		nm	IF=20mA
$\Delta\lambda_{1/2}$	Spectral Line Half-width	Yellow	35		nm	IF=20mA
C	Capacitance	Yellow	20		pF	VF=0V;f=1MHz
VF[2]	Forward Voltage	c,d,g,h,k,m,n,s,r,t	4.2	5.0	V	IF=20mA
		a,b,e,f,p,u and DP	2.1	2.5		
IR	Reverse Current	c,d,g,h,k,m,n,s,r,t		10	uA	VR = 10V
		a,b,e,f,p,u and DP		10		VR = 5V

Notes:

1. Wavelength: +/-1nm.

2. Forward Voltage: +/-0.1V.

Absolute Maximum Ratings at TA=25°C

Parameter	Yellow	Units
Power dissipation	c,d,g,h,k,m,n,s,r,t	150
	a,b,e,f,p,u and DP	75
DC Forward Current	c,d,g,h,k,m,n,s,r,t	30
	a,b,e,f,p,u and DP	
Peak Forward Current [1]	c,d,g,h,k,m,n,s,r,t	140
	a,b,e,f,p,u and DP	
Reverse Voltage	c,d,g,h,k,m,n,s,r,t	10
	a,b,e,f,p,u and DP	5
Operating/Storage Temperature	-40°C To +85°C	
Lead Solder Temperature [2]	260°C For 3-5 Seconds	

Notes:

1. 1/10 Duty Cycle, 0.1ms Pulse Width.

2. 2mm below package base.

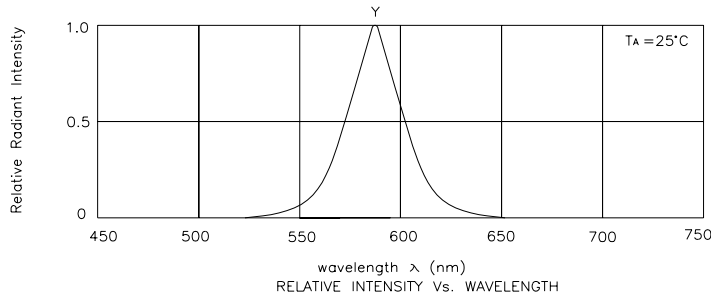

PSA12-11YWA Yellow

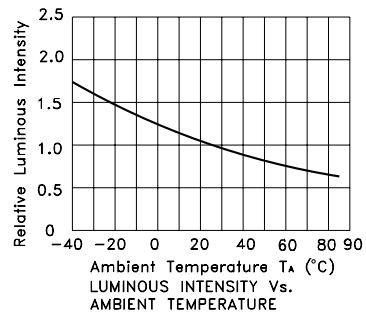
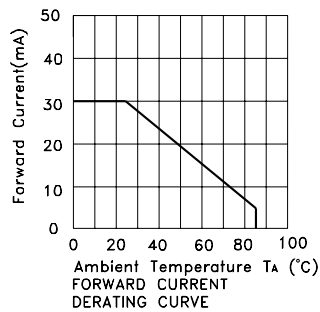
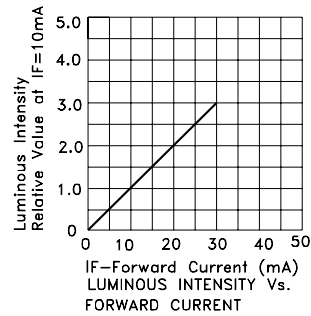
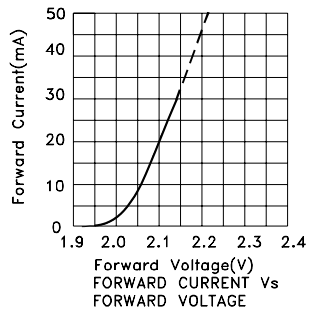

Note:the curves are on the segment a,b,e,f,p,u and DP.

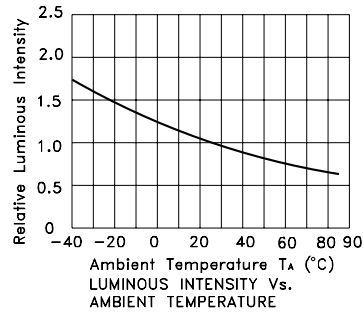
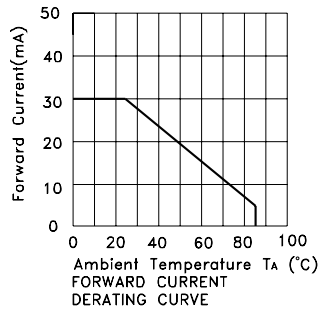
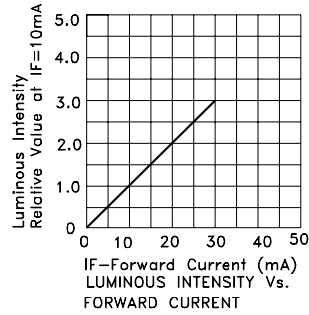
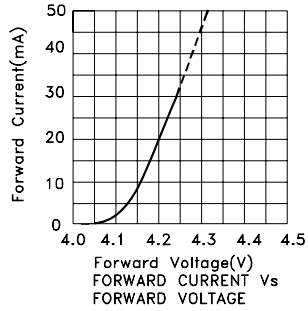

Note:the curves are on the segment c,d,g,h,k,m,n,s,r and t.

PACKING & LABEL SPECIFICATIONS

PSA12-11YWA

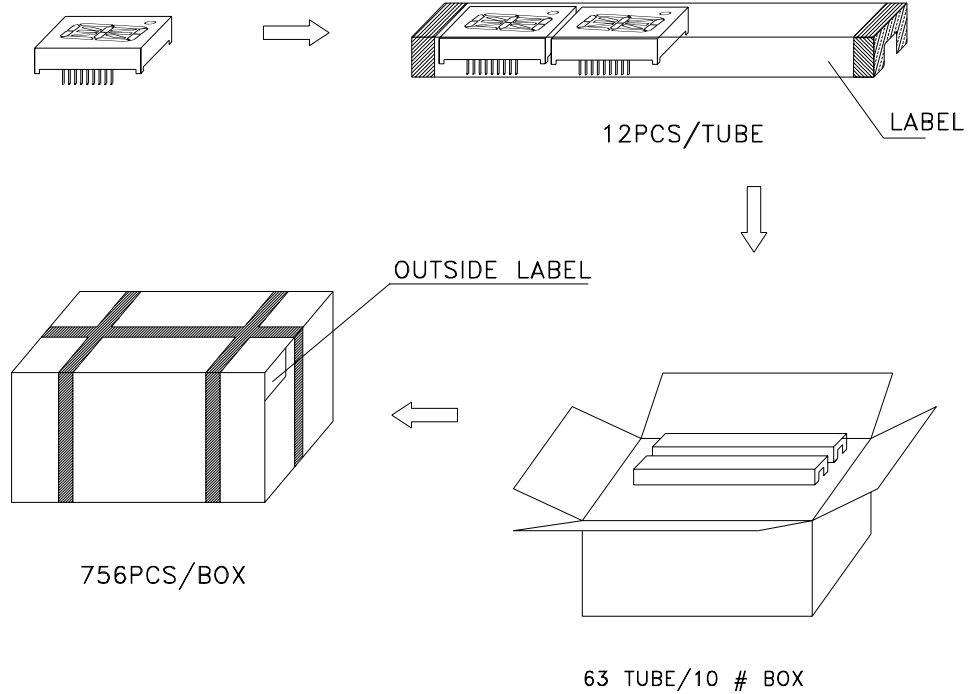

Inside LABEL Paste On The IC-tube

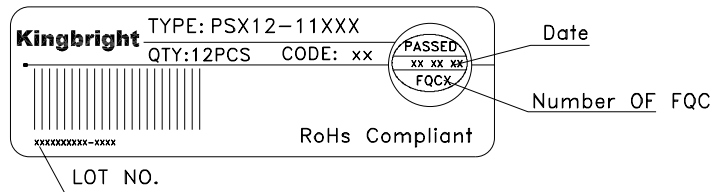

Outside LABEL Paste On The Box

