



WENRUN OPTOELECTRONIC CO., LTD.
Technical Data Sheet
LED Lamps

• Customer:

Technical Data Sheet

PN: [L□340□□ Series](#)

For: IF=20mA



Contents

- 1.Features
- 2.Descriptions
- 3.Applications
- 4.Selection guide
- 5.Package dimensions
- 6.Absolute maximum rating
- 7.Electrical optical characteristics
- 8.Reliability
- 9.Typical electro-optical characteristics curves
- 10.Label form specification
- 11.Precautions
- 12.Notes

Customer confirm	Approved by	Checked by	Issued by

Jiangsu Wenrun Optoelectronic Co.,Ltd.
No.88 Weiyi Road Dingmao Development Zone Zhenjiang
Tel: 0511-85510030 Fax: 0511-85512861



WENRUN OPTOELECTRONIC CO., LTD.

Technical Data Sheet

LED Lamps

Features:

- High speed response.
- High reliability and long life.
- Low power consumption.
- Available in red,blue,white ,green, yellow colors.
- Suitable for pulse operation.

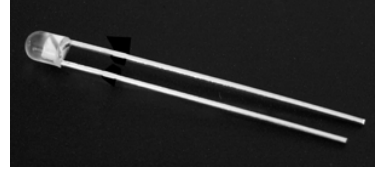

Descriptions:

- The LED lamps are available with different colors,intensities,epoxy colors,etc.
- The series specially designed for applications requiring higher brightness.
- Superior performance in outdoor environment.

Applications:

- These lamp are widely used for various application.
- Board for display.
- Indication of all kinds.
- Traffic Signal.

Selection Guide:

Part No.	Chip		Lens Type
	Material	Emitting Color	
LUB34043	InGaN	Ultra Super Blue	Water Clear
LUG34043	InGaN	Ultra Super Green	
LBG34043	InGaN	Ultra Super Bluish Green	

*Pay attention to electrostatic (ESD)

Package Dimensions:

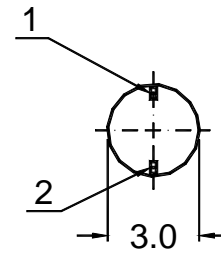
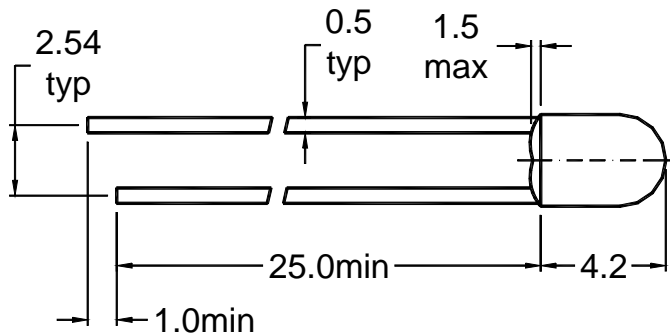

1.ANODE
2.CATHODE

NOTES :

- 1、 All dimensions are in millimetres (mm).
- 2、 Tolerance is $\pm 0.25\text{mm}(0.01\text{'})$ unless otherwise noted.
- 3、 Protruded resin under flange is 1.5mm Max LED.

Absolute Maximum Rating (Ta=25)

Parameter	Symbol	Ultra Super			Unit
		Blue	Green	Bluish Green	
Power Dissipation	P_d	100	100	100	mW
Pulse Forward Current (Duty 1/10 @ 1kHz)	I_{FP}	100	100	100	mA
DC Forward Current	I_F	25	25	25	mA
Reverse Voltage	V_R	5	5	5	V
Operating Temperature Range	T_{opr}	-40 ~ +85			
Storage Temperature Range	T_{stg}	-40 ~ +100			
Soldering Temperature	T_{sol}	260 \pm 5			

Notes : Soldering time 5 seconds.

I_{FP} condition: pulse width 1ms ,duty cycle 1/10.

T_{sol} condition : 3mm for the base of the epoxy bulb.



WENRUN OPTOELECTRONIC CO., LTD.
Technical Data Sheet
LED Lamps

Electrical Optical Characteristics (Ta=25)

Parameter	Symbol	Ultra Super						Unit	Test Condition
		Blue		Green		Bluish Green			
		Typ.	Max.	Typ.	Max.	Typ.	Max.		
Luminous Intensity	I _V	1000	--	3500	--	2500	--	mcd	I _F =20mA
Forward Voltage	V _F	3.2	3.8	3.1	3.8	3.1	3.8	V	I _F =20mA
Reverse Current	I _R	--	50	--	50	--	50	uA	V _R =5V
Dominant Wavelength	d	470	--	525	--	505	--	nm	I _F =20mA
Peak Emission Wavelength	p	465	--	518	--	503	--	nm	I _F =20mA
Spectral Line Half Width		30	--	30	--	30	--	nm	I _F =20mA
Recommond forward current	I _{F(rec)}	20	--	20	--	20	--	mA	--
Viewing Angle	2 1/2	30	--	30	--	30	--	deg	I _F =20mA

- Notes: 1. Tolerance of Luminous Intensity $\pm 10\%$
 2. Tolerance of Dominant Wavelength $\pm 2\text{nm}$
 3. Tolerance of Forward voltage $\pm 0.05\text{V}$
 4. Luminous Intensity is measured by WENRUN's equipment on bare chips



WENRUN OPTOELECTRONIC CO., LTD.

Technical Data Sheet

LED Lamps

Reliability

(1) Test Items and Conditions

NO	Test Item	Test Conditions	Sample	Ac/Re
1	Temperature Cycle	-40±5℃→25±5℃→100±5℃→25±5℃ (30min, 5min, 30min, 5min) 100 Cycles	20	0/1
2	High Temperature Storage	Ta: 100±5℃ Test time=1000HRS(-24HRS,+72HRS)	20	0/1
3	High Temperature And High Humidity Working	Ta: 85±5℃, RH:85±5%, IF=20mA Test time=500HRS(-24HRS,+72HRS)	20	0/1
4	Low Temperature Storage	Ta: -40±5℃ Test time=1000HRS(-24HRS,+72HRS)	20	0/1
5	Operating Life Test	Connect with a power IF=20mA Ta=Under room temperature Test time=1000HRS(-24HRS,+72HRS)	20	0/1
6	Solder Resistance	T.Sol=260±5℃ one time Dwell Time=10±1Secs	20	0/1
7	Thermal Shock	-40±5℃→100±5℃ (15min, 15min) 100 Cycles	20	0/1

(2)Criteria of judging the damage

Item	Symbol	Test condition	Criteria for judgement	
			Min.	Max.
Forward voltage	VF	IF=20 mA	/	U.S.L*1.1
Reverse current	IR	VR=5V	/	15uA
Luminous intensity	IV	IF=20 mA	L.S.L*0.7	/
Wave length	λ D/ λ P	IF=20 mA	/	U.S.L±2nm
Appearance	/	View check	No mechanical damage	

* U.S.L: Upper standard level

L.S.L: Lower standard level



WENRUN OPTOELECTRONIC CO., LTD.

Technical Data Sheet

LED Lamps

Typical Electro-Optical Characteristics Curves :

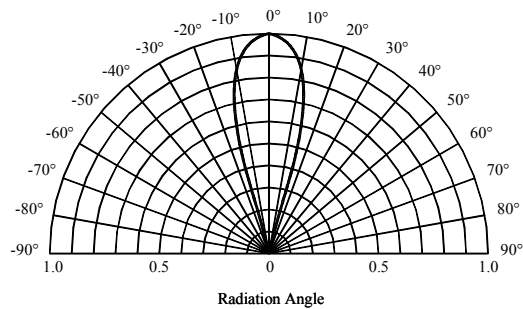
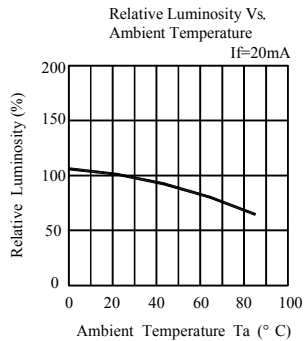
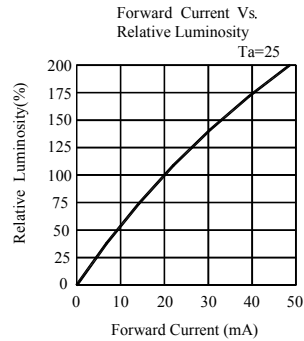
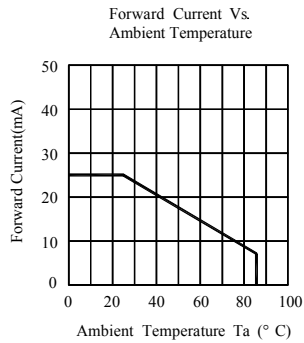
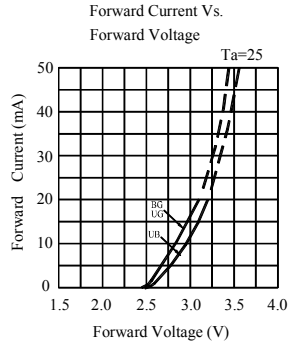
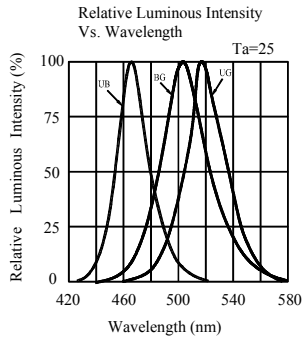



WENRUN OPTOELECTRONIC CO., LTD.

Technical Data Sheet

LED Lamps

Label Form Specification

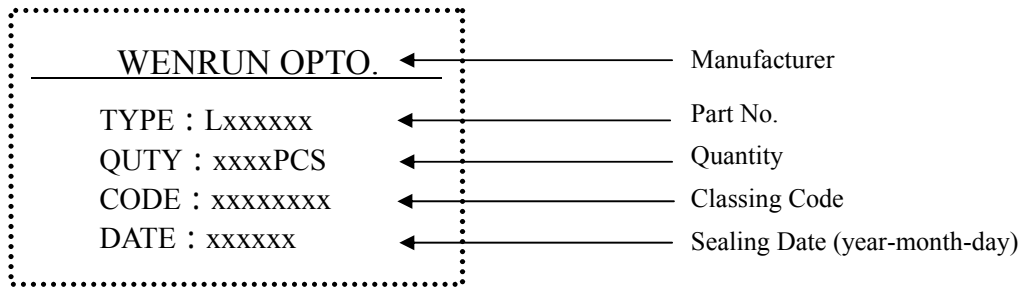

Precautions In Use

A、Soldering Conditions

- 1、 When soldering, leave the minimum clearance between the bottom of the resin and the soldering point.
- 2、 Maximum allowable soldering conditions are.
Solder dipping: 260 max., 5 seconds max., one time.
Soldering iron: 350 max., 5 seconds max., one time.
- 3、 Contact between molten solder and the resin must be avoided.
- 4、 In soldering, do not put any stress on the lead frame, particularly when heated.

B、Lead frame Forming and Use

- 1、 When forming leads ,the leads should be bent at a point at least 3mm from the base of epoxy. Lead forming should be done before soldering.
- 2、 Do not apply any bending stress to the base of the lead. The stress to the base may damage the LEDs characteristics.
- 3、 When mounting the LEDs onto a printed circuit board ,the holes on the circuit board should be exactly aligned with the leads of the LEDs.
- 4、 Please avoid conditions which may cause the LED to corrode, tarnish or discolor. This corrosion or discoloration may cause difficulty during soldering operations. It is recommended that the LEDs be used as soon as possible.
- 5、 Please avoid rapid transitions in ambient temperature, especially, in high humidity environments.

C、Storage

- 1、 The LEDs should be stored at 30 or less and 70%RH or less after being shipped from Wenrun and the storage life limits are 3 months . If the LEDs are stored for 3 months or more, they can be stored for a year in a sealed container with a nitrogen atmosphere and moisture absorbent material.
- 2、 Please avoid rapid transitions in ambient temperature, especially , in high humidity environments where condensation can occur.

D、Cleaning

- 1、 When necessary, cheaning should occur only with isopropyl alcohol at room temperature for a duration of no more than one minute . Dry at room temperature before use..



WENRUN OPTOELECTRONIC CO., LTD.

Technical Data Sheet

LED Lamps

2、 Do not clean the LEDs by the ultrasonic. When it is absolutely necessary , the influence of ultrasonic cleaning on the LEDs depends on factors such as ultrasonic power and the assembled condition. Ultrasonic cleaning shall be pre-qualified to ensure this will not cause damage to the LED.

E、 Circuit Protection

1、 Below the zener reference voltage V_Z , all the current flows through LED and as the voltage rises to V_Z , the zener diode “ breakdown . ” If the vlotage tries to rise above V_Z current flows through the zener branch to keep the voltage at exactly V_Z .

2、 When the LED is connected using serial circuit, if either piece of LED is no light up but current can not flow through causing others to light down.. In new design, the LEDis parallel with zener diode, if either piece of LED is no light up but current can flow through causing others to light up

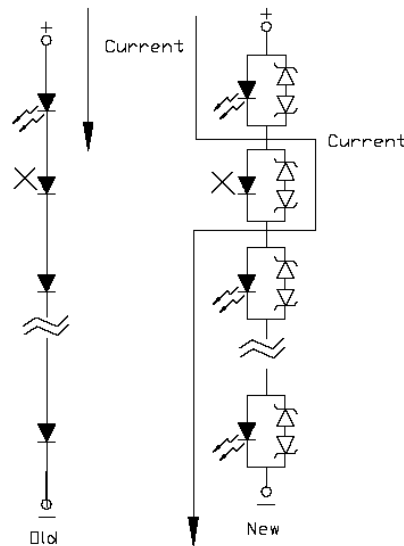

F、 Heat Management

1、 Heat management of LEDs must be taken into consideration during the design stage of LED application.The current should be de-rated appropriately by referring to the de-rating curve found in each product specification .

2、 The temperature surrounding the LED in the application should be controlled. Please refer to the data sheet de-rating curve.

G、 Static Electricity

1、 These products are sensitive to static electricity charge, and users are required to handle with care. Particularly, if an current and or voltage which exceeds the Absolute Maximum Rating of Products is applied, the overflow in energy may cause damage to, or possibly result in electrical destruction of, the Products. The customer is requested to take adequate countermeasures against static electricity charge and surge when handling Products.

2、 Proper grounding of Products , use of conductive mat, conductive working uniform and shoes, and conductive containers are effective against static electricity and surge.

3、 Ground low-resistance areas where the product contacts, such as metal surfaces of the work platform, with a conductive mat (surface resistance 10^6 - 10^8).



WENRUN OPTOELECTRONIC CO., LTD.

Technical Data Sheet

LED Lamps

4、 A tip of soldering iron is requested to be grounded. An ionizer should also be installed where risk of static generation is high.

Notes:

- 1、 Above specification may be changed without notice. We will reserve authority on material change for above specification.
- 2、 When using this product, please observe the absolute maximum ratings and the instructions for the specification sheets. We assume no responsibility for any damage resulting from use of the product which does not comply with the instructions included in the specification sheets.