



PSC360

PSC360U

### STANDARD SPECIFICATIONS

- Linearity:  $\pm 1\%$  absolute (0.5% upon request)
- Simple & Robust Magnetic Design
- Programmable Angular Range from 15 to 360 Degrees (without dead band)
- Programmable Linear Transfer Characteristic  
(some positive slopes & one negative slope can be programmed in the same transfer characteristic; up to 4 programmable points; see last page)
- Selectable Analog (Ratiometric), PWM, Serial Protocol
- Programmable switch output
- Angular Resolution  
Analog & PWM: 12 bits  
Serial Protocol (SPI): 14 bits
- Full Redundant option upon request
- 40 bit ID Number
- Self-Diagnostic features
- Rotational life: >50.000.000 cycles  
(depending on application and mounting)
- Operating temperature: up to  $-40^{\circ}\text{C}$  to  $+150^{\circ}\text{C}$
- +20V over voltage protection and  $-10\text{V}$  reverse voltage protection
- Supply voltage: 5V  $\pm 10\%$  (others upon request)
- IP65 (others upon request)

### APPLICATION EXAMPLES

- Non-Contacting long life angle/position sensor
- Absolute Rotary Position Sensor
- Pedal Position Sensor
- Throttle/EGR Valve and Gear Position Sensor
- Height & suspension Sensor
- Non-Contacting Potentiometer
- Float-Level Sensor
- Motor-shaft Position Sensor
- Precision Robotics, industrial equipment, HVAC monitoring & control...

### DESCRIPTION

The PSC-360 is a vertical Hall-effect magnetic sensor that is designed to overcome the limitations of potentiometer-based devices in a wide range of applications. The performance of magnetic sensors has traditionally been limited by their poor tolerance to thermal and magnetic fluctuations. And although these limitations can be overcome by careful circuit design, the complexity this has entailed has often discouraged OEMs from designing with these sensors.

The technology used by Piher is only sensitive to the flux density coplanar with the IC surface. This allows to precisely feedback the absolute position from 15 to 360 degrees. It enables the design of low-cost high performance non-contacting rotary position sensors for both automotive and industrial applications without the limitations of potentiometric solutions (wear, limited electrical angles...) A configurable switch output is integrated within the sensor too.

Furthermore full redundancy can be achieved by employing a dual core version or the simple placement of two sensors within the housing.

The robust PSC360 is sealed and flange mounted for easy positioning when necessary. It provides high stability under harsh environment conditions such as vibration, shock, extreme temperatures / humidity, dither, moisture or dirt. Featuring a modular architecture, electrical & mechanical characteristics can be fully customised to customer's needs as well as connector configurations. Panel mount package for bush mounting is also available.

This product shows Piher's competences in sensors for use in harsh environments and custom product tailoring for use on Tier One and OEM platforms.

### STANDARDS

- EN 55022 class B, emission radiated (30 ... 230 MHz)
- EN 55022, class B, emission radiated (230 ... 1000MHz)
- EN 61000-4-2, ESD on housing and connections (contact / air)
- EN 61000-4-3, immision HF radiated (80 ... 1000MHz)
- EN 61000-4-4, Burst (on supply lines / signal lines)
- EN 61000-4-5, Surge (on supply lines / signal lines)
- EN 61000-4-6, immision HF conducted (0.15 ... 80MHz)
- EN 61000-4-8. immision magnetic field (50Hz)
- IEC 60393-1, Insulation resistance (500VDC, 1bar, 2s)
- IEC 60393-1, Dielectric strenght (VAC, 50Hz, 1min, 1bar)
- IEC 68-2-6, Vibration (Amax=0.75mm, f=5 ... 2000 Hz)
- IEC 68-2-27 Shock

Information contained in and/or attached to this catalogue may be subject to export control regulations of the European Community, USA, or other countries. Each recipient of this document is responsible to ensure that usage and/or transfer of any information contained in this document complies with all relevant export control regulations. If you are in any doubt about the export control restrictions that apply to this information, please contact the sender immediately. For any Piher International Corp. Exports, Note: All products / technologies are EAR99 Classified commodities. Exports from the United States are in accordance with the Export Administration Regulations. Diversion contrary to US law is prohibited.



NOTE: The information contained here should be used for reference purposes only.

## HOW TO ORDER

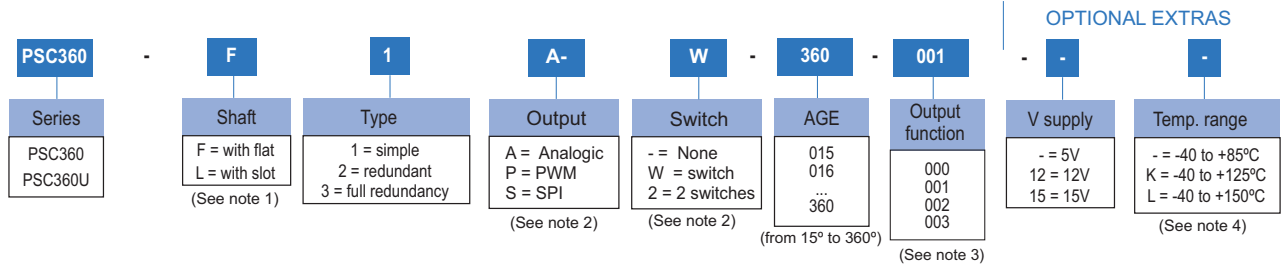

## HOW TO ORDER CUSTOM DRAWING

SERIES - BUSHING+SHAFT - DRAWING NUMBER(16 digits) - REST OF HOW TO ORDER

This way of ordering should be used for options which are not included in the "How to order" standard and optional extras.  
Example:

PSC360-F-123456-----1A---XXX-008

123456 is the drawing number  
Special angle  
Special output function

### NOTES:

- "L" version is only available for PSC360U
- Switch available only for Analogic & PWM output types. In redundant models, please select two output types according to the following table:

**Available options** (1) non redundant (2) redundant (3) full redundancy:

- (1) A--
- (1) A-W
- (1) P--
- (1) P-W
- (1) S--
- (2)(3) AA-
- (2)(3) AAW
- (2)(3) AA2
- (2)(3) PP-
- (2)(3) PPW
- (2)(3) PP2
- (2)(3) AP-
- (2)(3) APW
- (2)(3) AP2
- (2)(3) SS-

- Others upon request.
- Standard Temperature range: -40 to +85°C; "L" option only available for PSC360U

## STANDARD OUTPUT FUNCTIONS

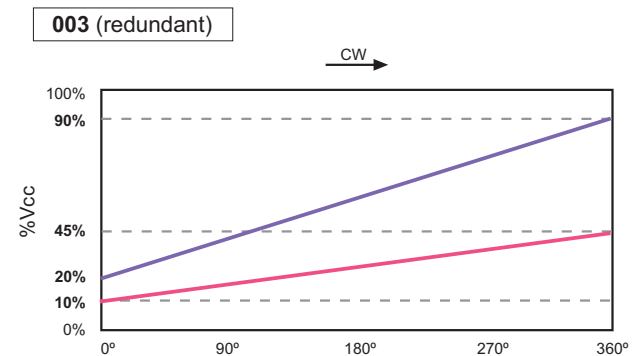
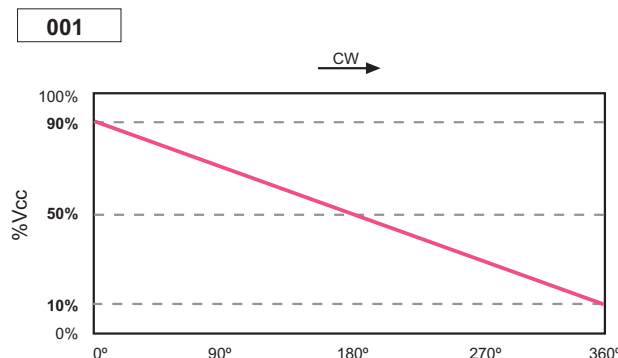
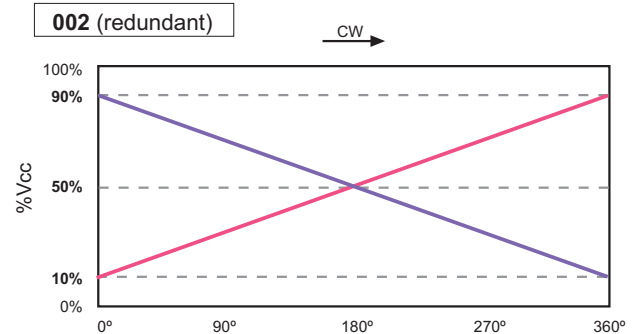
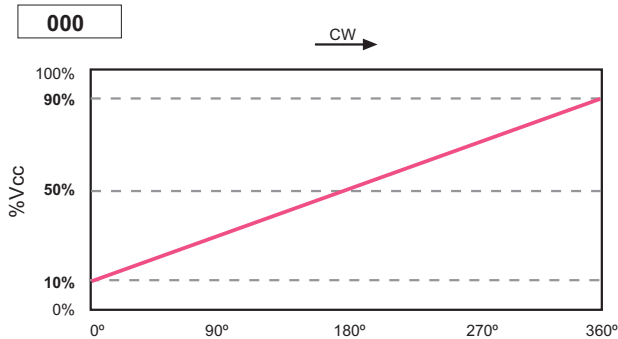

## PSC-360 DIMENSIONS

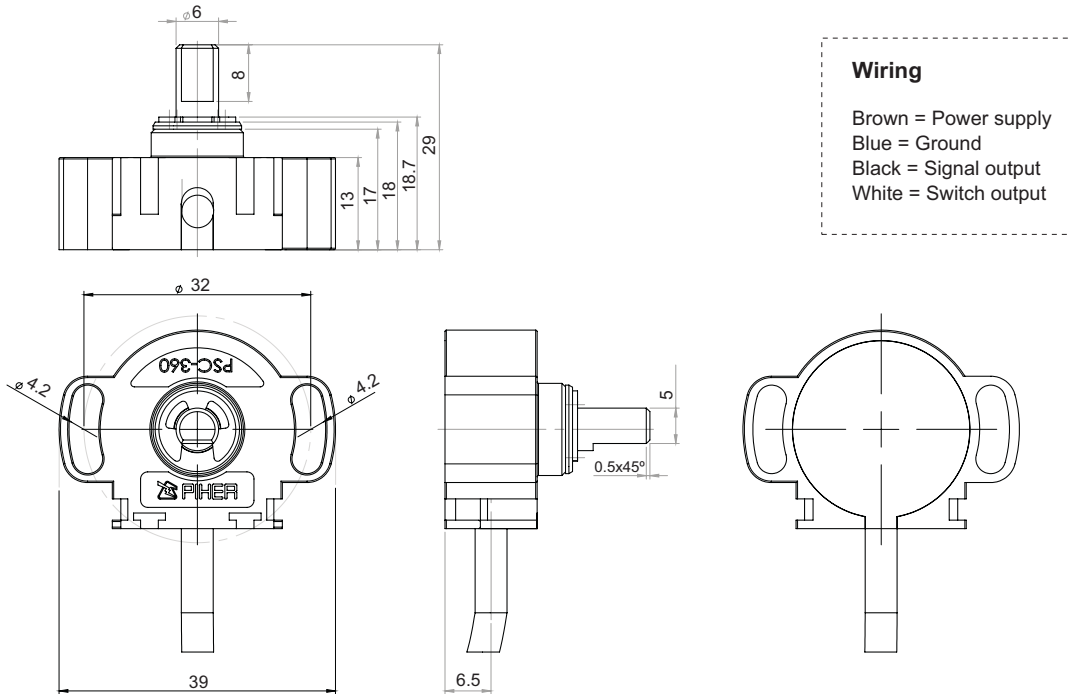

Note: shaft at zero position

## PSC-360U DIMENSIONS (PANEL MOUNT VERSION)

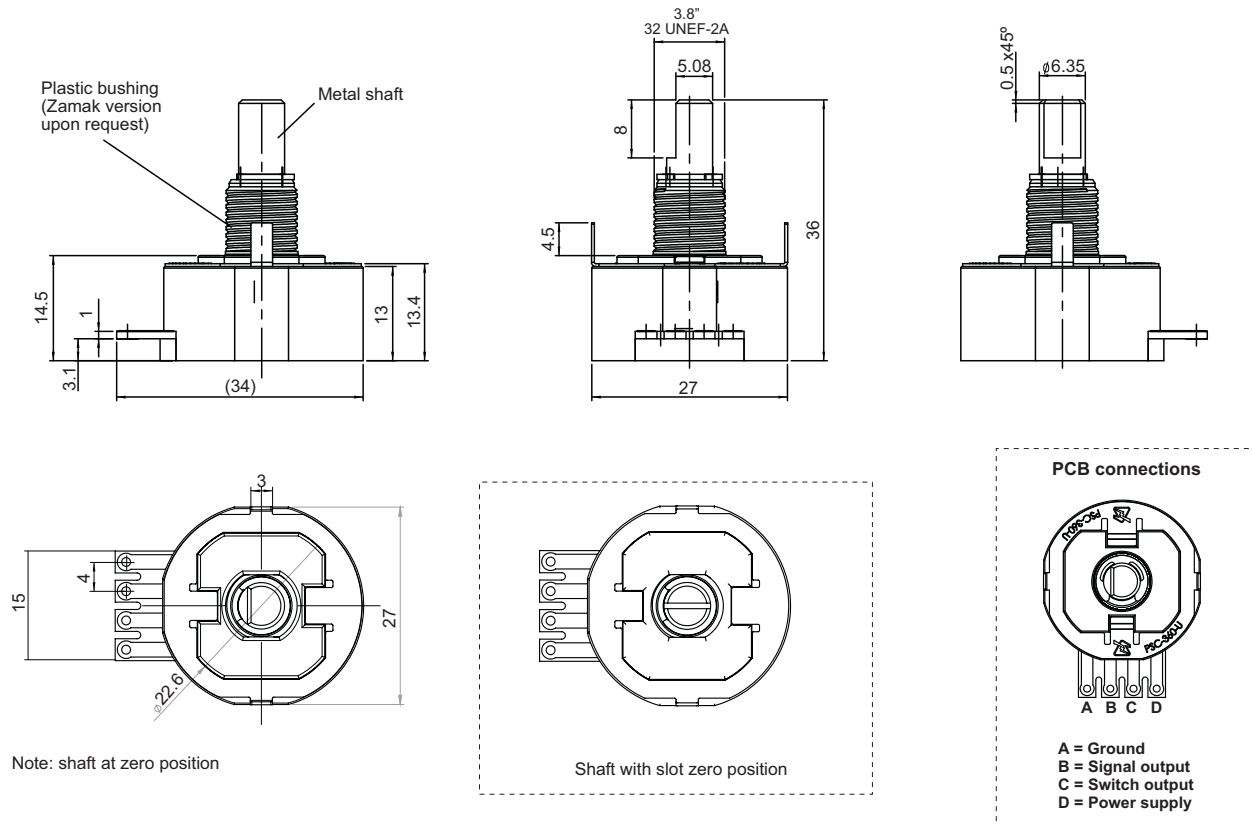

Note: shaft at zero position

Shaft with slot zero position

## OUTPUT FUNCTION EXAMPLES

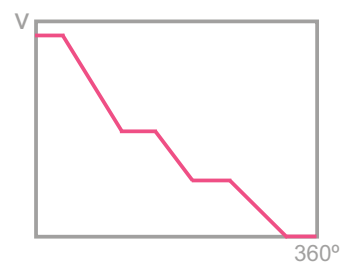
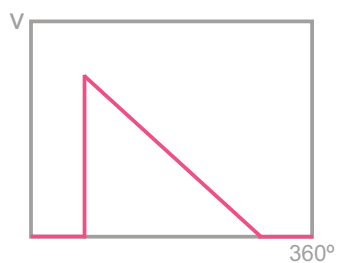
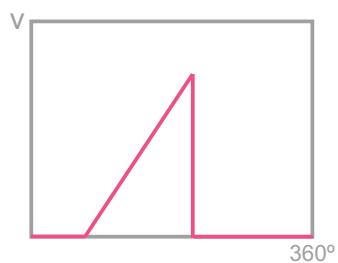
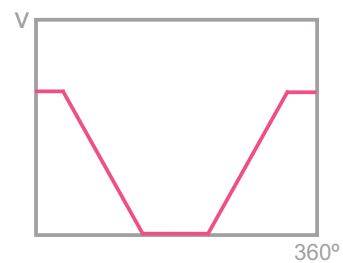
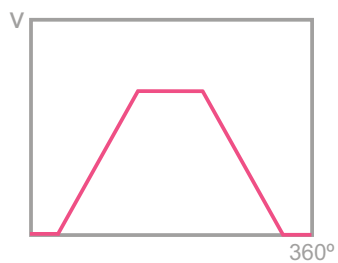
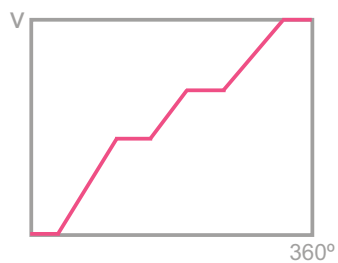
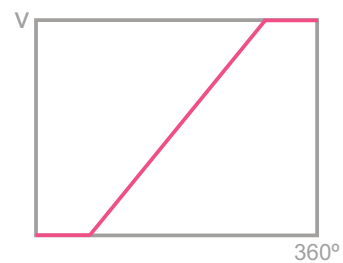
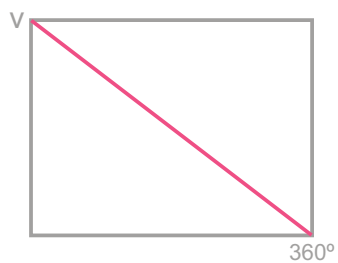
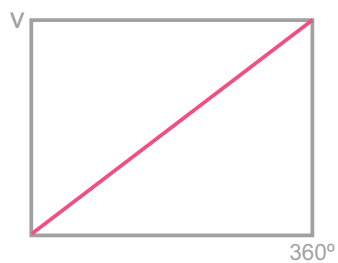

Redundant examples:

