

LMV2011

High Precision, Rail-to-Rail Output Operational Amplifier

General Description

The LMV2011 is a new precision amplifier that offers unprecedented accuracy and stability at an affordable price and is offered in miniature (SOT23-5) package and in 8 lead SOIC package. This device utilizes patented techniques to measure and continually correct the input offset error voltage. The result is an amplifier which is ultra stable over time and temperature. It has excellent CMRR and PSRR ratings, and does not exhibit the familiar 1/f voltage and current noise increase that plagues traditional amplifiers. The combination of the LMV2011 characteristics makes it a good choice for transducer amplifiers, high gain configurations, ADC buffer amplifiers, DAC I-V conversion, and any other 2.7V-5V application requiring precision and long term stability.

Other useful benefits of the LMV2011 are rail-to-rail output, a low supply current of 930µA, and wide gain-bandwidth product of 3MHz. These extremely versatile features found in the LMV2011 provide high performance and ease of use.

Features

(For $V_s = 5V$, Typical unless otherwise noted)

- Low Guaranteed V_{os} over temperature 35µV
- Low Noise with no 1/f 35nV/√Hz
- High CMRR 130dB
- High PSRR 120dB
- High A_{VOL} 130dB
- Wide gain-bandwidth product 3MHz
- High slew rate 4V/µs
- Low supply current 930µA
- Rail-to-rail output 30mV
- No external capacitors required

Applications

- Precision Instrumentation Amplifiers
- Thermocouple Amplifiers
- Strain Gauge Bridge Amplifier

Connection Diagrams

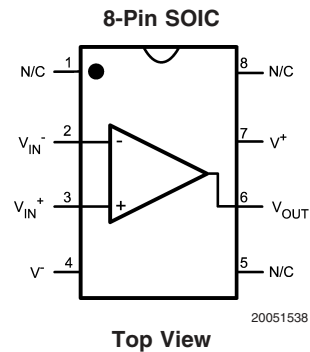
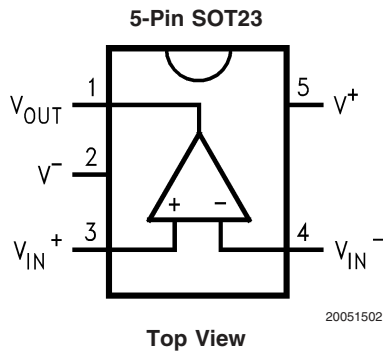

Ordering Information

Package	Part Number	Package Marking	Transport Media	NSC Drawing
5-Pin SOT23	LMV2011MF	A84A	1k Units Tape and Reel	MF05A
	LMV2011MFX		3k Units Tape and Reel	
8-Pin SOIC	LMV2011MA	LMV2011MA	95 Units/Rail	M08A
	LMV2011MAX		2.5k Units Tape and Reel	

Absolute Maximum Ratings (Note 1)

If Military/Aerospace specified devices are required, please contact the National Semiconductor Sales Office/Distributors for availability and specifications.

ESD Tolerance

Human Body Model	2000V
Machine Model	200V
Supply Voltage	5.5V
Common-Mode Input Voltage	$-0.3 \leq V_{CM} \leq V_{CC} + 0.3V$

Lead Temperature (soldering
10 sec.)

+300°C

Operating Ratings (Note 1)

Supply Voltage	2.7V to 5V
Storage Temperature Range	-65°C to 150°C
Operating Temperature Range	0°C to 70°C

2.7V DC Electrical Characteristics Unless otherwise specified, all limits guaranteed for $T_J = 25^\circ\text{C}$, $V^+ = 2.7V$, $V^- = 0V$, $V_{CM} = 1.35V$, $V_O = 1.35V$ and $R_L > 1M\Omega$. **Boldface** limits apply at the temperature extremes.

Symbol	Parameter	Conditions	Min	Typ	Max	Units
V_{OS}	Input Offset Voltage			0.8	25 35	μV
	Offset Calibration Time			0.5	10 12	ms
TCV_{OS}	Input Offset Voltage			0.015		$\mu\text{V}/^\circ\text{C}$
	Long-Term Offset Drift			0.006		$\mu\text{V}/\text{month}$
	Lifetime V_{OS} Drift			2.5		μV
I_{IN}	Input Current			-3		pA
I_{OS}	Input Offset Current			6		pA
R_{IND}	Input Differential Resistance			9		$M\Omega$
CMRR	Common Mode Rejection Ratio	$-0.3 \leq V_{CM} \leq 0.9V$ $0 \leq V_{CM} \leq 0.9V$		130	95 90	dB
PSRR	Power Supply Rejection Ratio			120	95 90	dB
A_{VOL}	Open Loop Voltage Gain	$R_L = 10k\Omega$		130	95 90	dB
		$R_L = 2k\Omega$		124	90 85	
V_O	Output Swing	$R_L = 10k\Omega$ to 1.35V $V_{IN}(\text{diff}) = \pm 0.5V$	2.665	2.68		V
			2.655	0.033	0.060 0.075	
		$R_L = 2k\Omega$ to 1.35V $V_{IN}(\text{diff}) = \pm 0.5V$	2.630	2.65		V
			2.615	0.061	0.085 0.105	
I_O	Output Current	Sourcing, $V_O = 0V$ $V_{IN}(\text{diff}) = \pm 0.5V$		12	5 3	mA
		Sinking, $V_O = 5V$ $V_{IN}(\text{diff}) = \pm 0.5V$		18	5 3	
R_{OUT}	Output Impedance					Ω
I_S	Supply Current			0.919	1.20 1.50	mA

2.7V AC Electrical Characteristics $T_J = 25^\circ\text{C}$, $V^+ = 2.7V$, $V^- = 0V$, $V_{CM} = 1.35V$, $V_O = 1.35V$, and $R_L > 1M\Omega$. **Boldface** limits apply at the temperature extremes.

Symbol	Parameter	Conditions	Min	Typ	Max	Units
GBW	Gain-Bandwidth Product			3		MHz
SR	Slew Rate			4		V/ μs
θ_m	Phase Margin			60		Deg

2.7V AC Electrical Characteristics

$T_J = 25^\circ\text{C}$, $V^+ = 2.7\text{V}$, $V^- = 0\text{V}$, $V_{\text{CM}} = 1.35\text{V}$, $V_O = 1.35\text{V}$, and $R_L > 1\text{M}\Omega$. **Boldface** limits apply at the temperature extremes. (Continued)

Symbol	Parameter	Conditions	Min	Typ	Max	Units
G_m	Gain Margin			-14		dB
e_n	Input-Referred Voltage Noise			35		$\text{nV}/\sqrt{\text{Hz}}$
i_n	Input-Referred Current Noise					$\mu\text{A}/\sqrt{\text{Hz}}$
$e_{n\text{p-p}}$	Input-Referred Voltage Noise	$R_S = 100\Omega$, DC to 10Hz		850		nV_{pp}
t_{rec}	Input Overload Recovery Time			50		ms
t_s	Output Settling time	$A_V = +1$, $R_L = 2\text{k}\Omega$ 1V Step	1%			ns
			0.1%			
			0.01%			
		$A_V = -1$, $R_L = 2\text{k}\Omega$ 1V Step	1%			
			0.1%			
			0.01%			

5V DC Electrical Characteristics

Unless otherwise specified, all limits guaranteed for $T_J = 25^\circ\text{C}$, $V^+ = 5\text{V}$, $V^- = 0\text{V}$, $V_{\text{CM}} = 2.5\text{V}$, $V_O = 2.5\text{V}$ and $R_L > 1\text{M}\Omega$. **Boldface** limits apply at the temperature extremes.

Symbol	Parameter	Conditions	Min	Typ	Max	Units
V_{OS}	Input Offset Voltage			0.12	25 35	μV
	Offset Calibration Time			0.5	10 12	ms
TCV_{OS}	Input Offset Voltage			0.015		$\mu\text{V}/^\circ\text{C}$
	Long-Term Offset Drift			0.006		$\mu\text{V}/\text{month}$
	Lifetime V_{OS} Drift			2.5		μV
I_{IN}	Input Current			-3		μA
I_{OS}	Input Offset Current			6		μA
R_{IND}	Input Differential Resistance			9		$\text{M}\Omega$
CMRR	Common Mode Rejection Ratio	$-0.3 \leq V_{\text{CM}} \leq 3.2$ $0 \leq V_{\text{CM}} \leq 3.2$		130	100 90	dB
PSRR	Power Supply Rejection Ratio			120	95 90	dB
A_{VOL}	Open Loop Voltage Gain	$R_L = 10\text{k}\Omega$		130	105 100	dB
		$R_L = 2\text{k}\Omega$		132	95 90	
V_O	Output Swing	$R_L = 10\text{k}\Omega$ to 2.5V $V_{\text{IN}}(\text{diff}) = \pm 0.5\text{V}$	4.96	4.978		V
			4.95		0.040	
		$R_L = 2\text{k}\Omega$ to 2.5V $V_{\text{IN}}(\text{diff}) = \pm 0.5\text{V}$	4.895	4.919		V
			4.875		0.091	
I_O	Output Current	Sourcing, $V_O = 0\text{V}$ $V_{\text{IN}}(\text{diff}) = \pm 0.5\text{V}$		15	8 6	mA
		Sinking, $V_O = 5\text{V}$ $V_{\text{IN}}(\text{diff}) = \pm 0.5\text{V}$		17	8 6	

5V DC Electrical Characteristics Unless otherwise specified, all limits guaranteed for $T_J = 25^\circ\text{C}$, $V^+ = 5\text{V}$, $V^- = 0\text{V}$, $V_{CM} = 2.5\text{V}$, $V_O = 2.5\text{V}$ and $R_L > 1\text{M}\Omega$. **Boldface** limits apply at the temperature extremes. (Continued)

Symbol	Parameter	Conditions	Min	Typ	Max	Units
R_{OUT}	Output Impedance					Ω
I_S	Supply Current per Channel			0.930	1.20 1.50	mA

5V AC Electrical Characteristics $T_J = 25^\circ\text{C}$, $V^+ = 5\text{V}$, $V^- = 0\text{V}$, $V_{CM} = 2.5\text{V}$, $V_O = 2.5\text{V}$, and $R_L > 1\text{M}\Omega$. **Boldface** limits apply at the temperature extremes.

Symbol	Parameter	Conditions	Min	Typ	Max	Units
GBW	Gain-Bandwidth Product			3		MHz
SR	Slew Rate			4		V/ μs
θ_m	Phase Margin			60		deg
G_m	Gain Margin			-15		dB
e_n	Input-Referred Voltage Noise			35		nV/ $\sqrt{\text{Hz}}$
i_n	Input-Referred Current Noise					pA/ $\sqrt{\text{Hz}}$
$e_{n,p-p}$	Input-Referred Voltage Noise	$R_S = 100\Omega$, DC to 10Hz		850		nV _{pp}
t_{rec}	Input Overload Recovery Time			50		ms
t_S	Output Settling time	$A_V = +1$, $R_L = 2\text{k}\Omega$ 1V Step	1%			ns
			0.1%			
			0.01%			
		$A_V = -1$, $R_L = 2\text{k}\Omega$ 1V Step	1%			
			0.1%			
			0.01%			

Note 1: Absolute Maximum Ratings indicate limits beyond which damage may occur. Operating Ratings indicate conditions for which the device is intended to be functional, but specific performance is not guaranteed. For guaranteed specifications and test conditions, see the Electrical Characteristics.

Typical Performance Characteristics

$T_A=25^\circ\text{C}$, $V_S=5\text{V}$ unless otherwise specified.

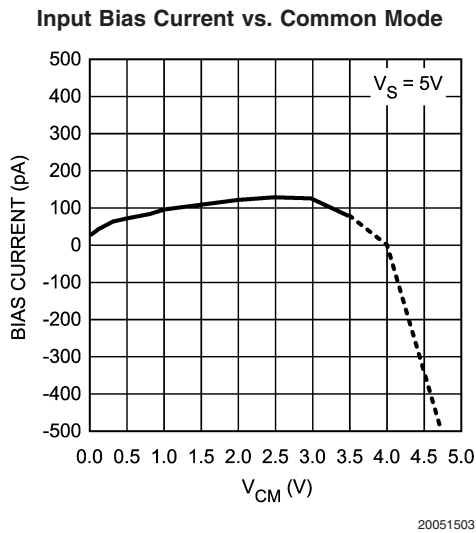
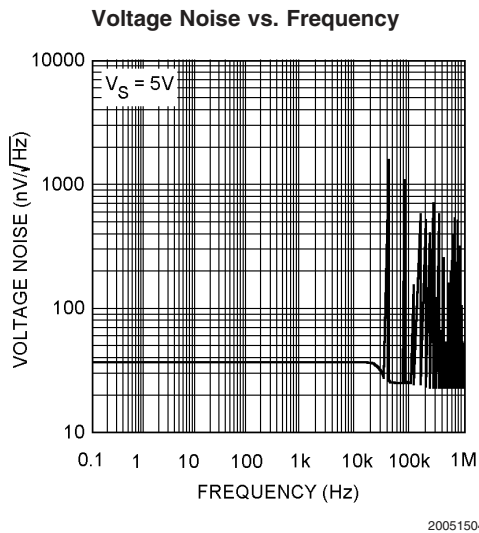
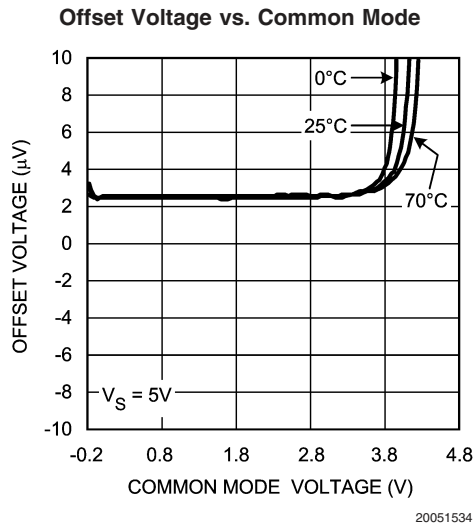
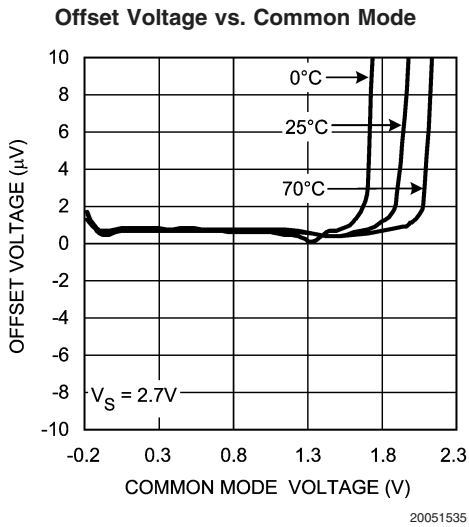
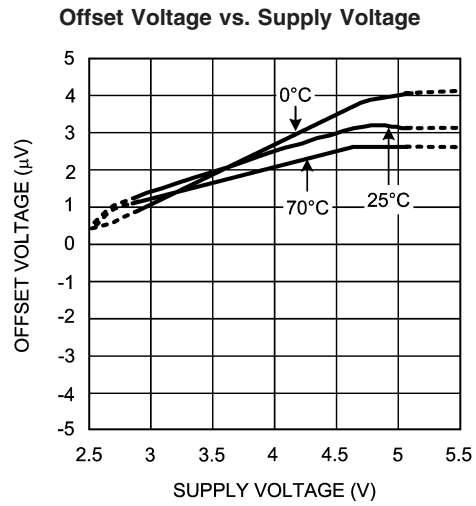
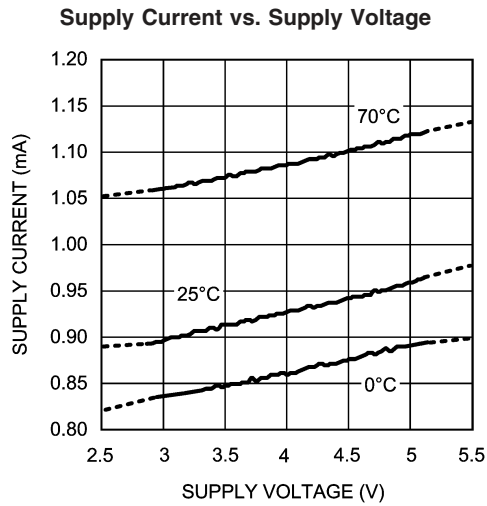

Typical Performance Characteristics (Continued)

PSRR vs. Frequency

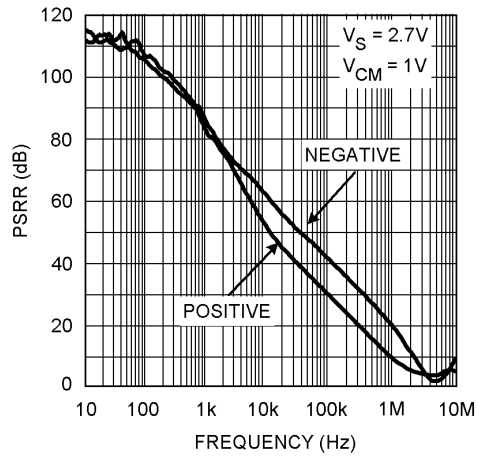

20051507

PSRR vs. Frequency

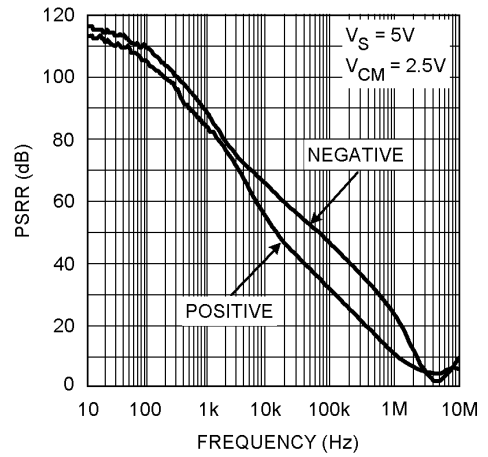

20051506

Output Sourcing @ 2.7V

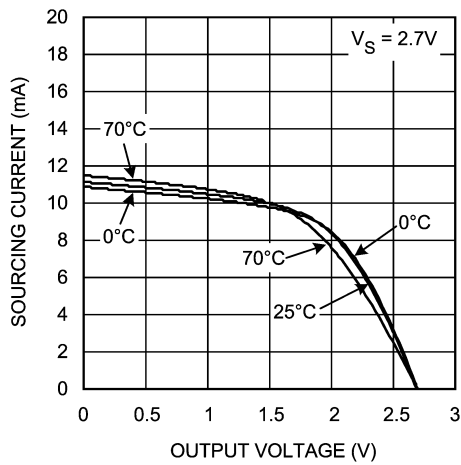

20051526

Output Sourcing @ 5V

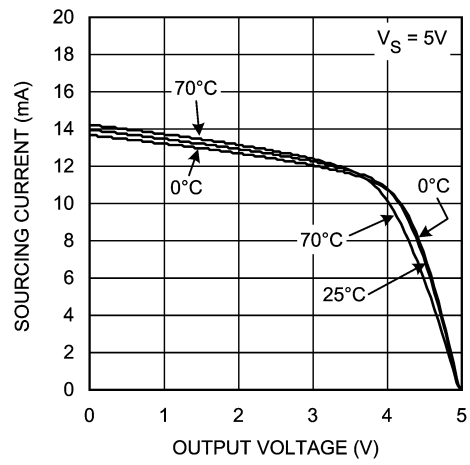

20051527

Output Sinking @ 2.7V

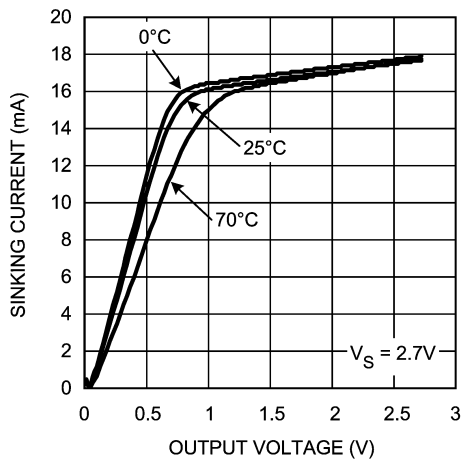

20051528

Output Sinking @ 5V

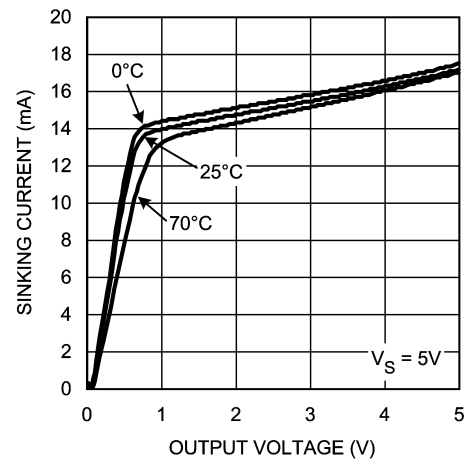

20051529

Typical Performance Characteristics (Continued)

Max Output Swing vs. Supply Voltage

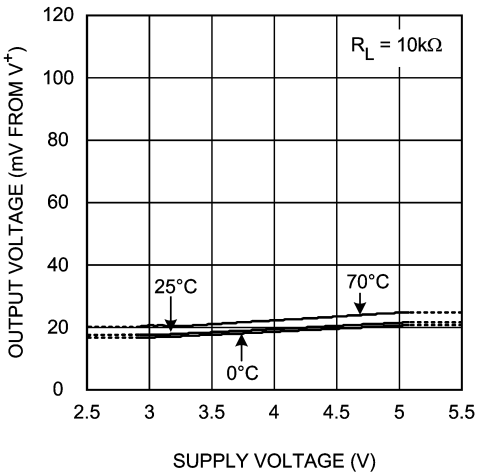

Max Output Swing vs. Supply Voltage

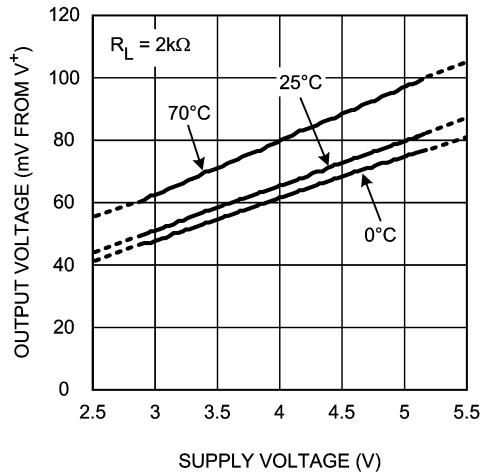

Min Output Swing vs. Supply Voltage

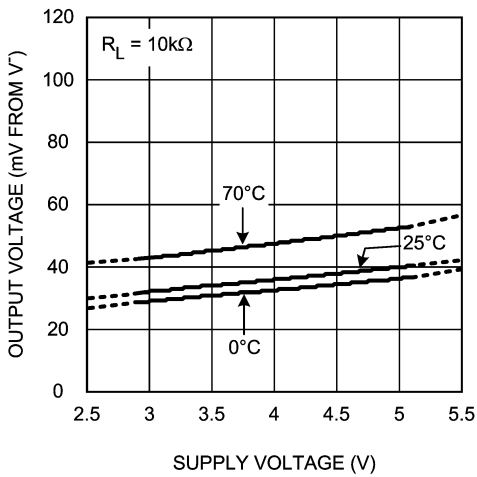

Min Output Swing vs. Supply Voltage

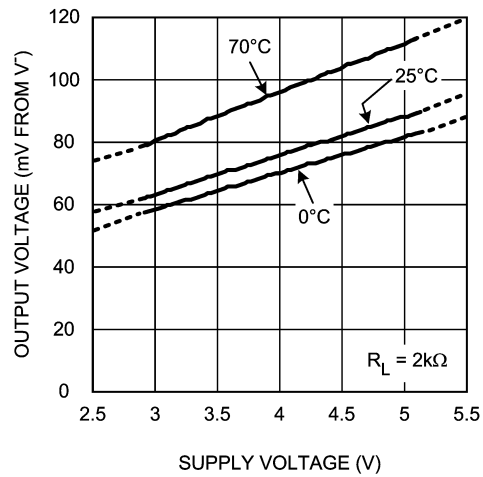

CMRR vs. Frequency

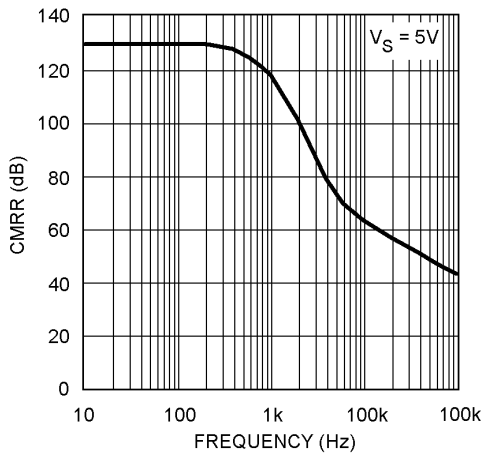

Open Loop Gain and Phase vs. Supply Voltage

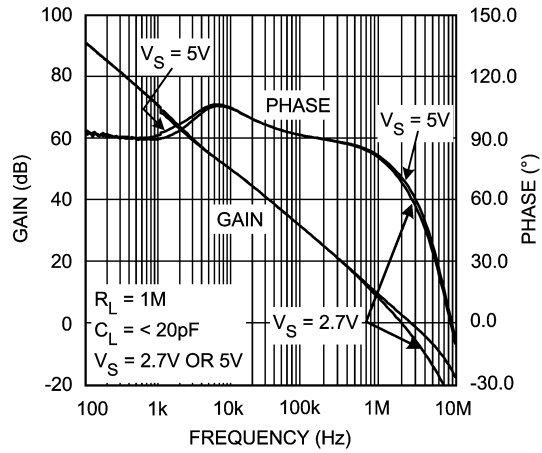

Typical Performance Characteristics (Continued)

Open Loop Gain and Phase vs. R_L @ 2.7V

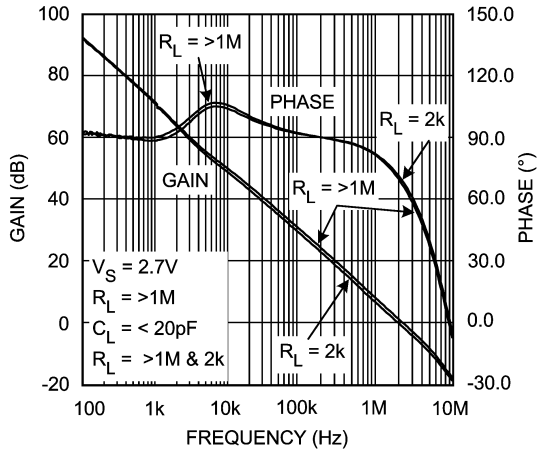

20051509

Open Loop Gain and Phase vs. R_L @ 5V

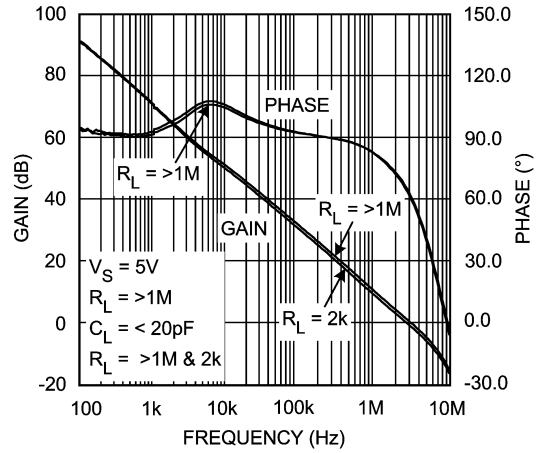

20051510

Open Loop Gain and Phase vs. C_L @ 2.7V

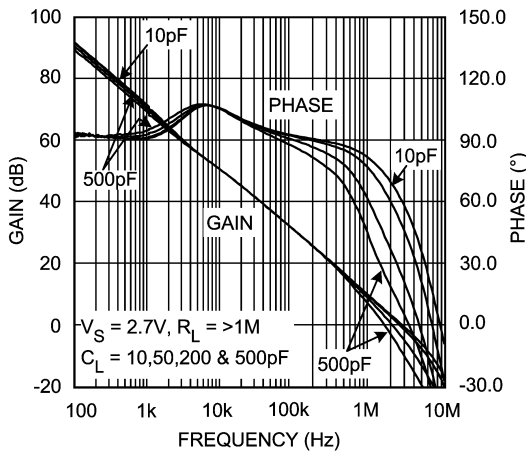

20051511

Open Loop Gain and Phase vs. C_L @ 5V

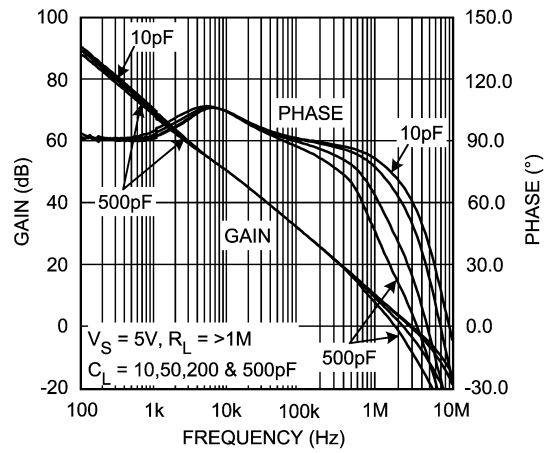

20051512

Open Loop Gain and Phase vs. Temperature @ 2.7V

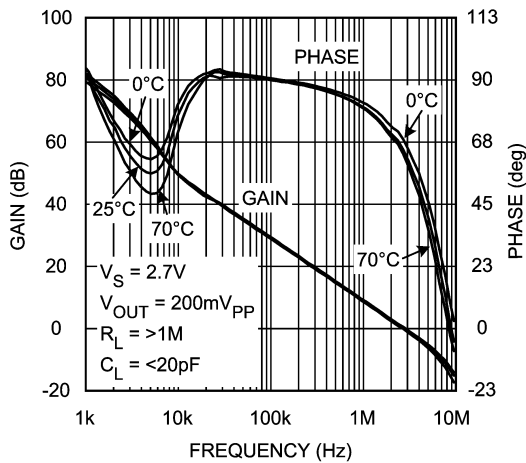

20051536

Open Loop Gain and Phase vs. Temperature @ 5V

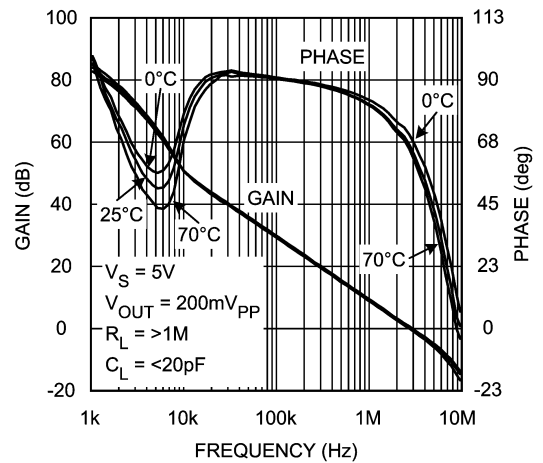

20051537

Typical Performance Characteristics (Continued)

THD+N vs. AMPL

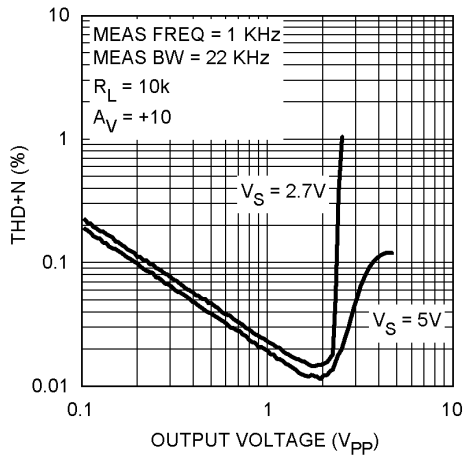

20051514

THD+N vs. Frequency

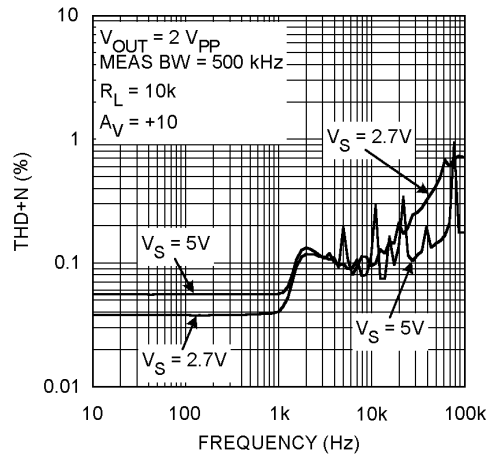

20051513

0.1Hz - 10Hz Noise vs. Time

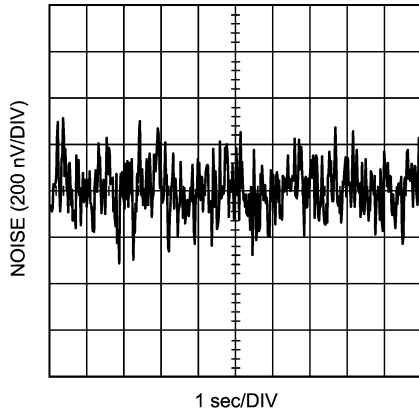

20051515

Application Information

THE BENEFITS OF LMV2011 NO 1/f NOISE

Using patented methods, the LMV2011 eliminates the 1/f noise present in other amplifiers. That noise, which increases as frequency decreases, is a major source of measurement error in all DC-coupled measurements. Low-frequency noise appears as a constantly-changing signal in series with any measurement being made. As a result, even when the measurement is made rapidly, this constantly-changing noise signal will corrupt the result. The value of this noise signal can be surprisingly large. For example: If a conventional amplifier has a flat-band noise level of $10\text{nV}/\sqrt{\text{Hz}}$ and a noise corner of 10Hz, the RMS noise at 0.001Hz is $1\mu\text{V}/\sqrt{\text{Hz}}$. This is equivalent to a 0.50 μV peak-to-peak error, in the frequency range 0.001 Hz to 1.0 Hz. In a circuit with a gain of 1000, this produces a 0.50mV peak-to-peak output error. This number of 0.001 Hz might appear unreasonably low, but when a data acquisition system is operating for 17 minutes, it has been on long enough to include this error. In this same time, the LMV2011 will only have a 0.21mV output error. This is smaller by 2.4 x. Keep in mind that this 1/f error gets even larger at lower frequencies. At the extreme, many people try to reduce this error by integrating or taking several samples of the same signal. This is also doomed to failure because the 1/f nature of this noise means that taking longer samples just moves the measurement into lower frequencies where the noise level is even higher.

The LMV2011 eliminates this source of error. The noise level is constant with frequency so that reducing the bandwidth reduces the errors caused by noise.

Another source of error that is rarely mentioned is the error voltage caused by the inadvertent thermocouples created when the common "Kovar type" IC package lead materials are soldered to a copper printed circuit board. These steel-based leadframe materials can produce over $35\mu\text{V}/^\circ\text{C}$ when soldered onto a copper trace. This can result in thermocouple noise that is equal to the LMV2011 noise when there is a temperature difference of only 0.0014°C between the lead and the board!

For this reason, the lead-frame of the LMV2011 is made of copper. This results in equal and opposite junctions which cancel this effect. The extremely small size of the SOT-23 package results in the leads being very close together. This further reduces the probability of temperature differences and hence decreases thermal noise.

OVERLOAD RECOVERY

The LMV2011 recovers from input overload much faster than most chopper-stabilized opamps. Recovery from driving the amplifier to 2X the full scale output, only requires about 40ms. Many chopper-stabilized amplifiers will take from 250ms to several seconds to recover from this same overload. This is because large capacitors are used to store the unadjusted offset voltage.

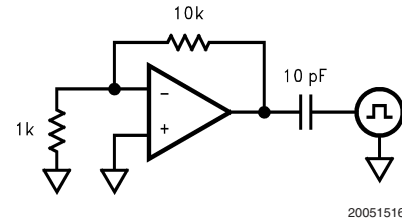

FIGURE 1.

The wide bandwidth of the LMV2011 enhances performance when it is used as an amplifier to drive loads that inject transients back into the output. ADCs (Analog-to-Digital Converters) and multiplexers are examples of this type of load. To simulate this type of load, a pulse generator producing a 1V peak square wave was connected to the output through a 10pF capacitor. (Figure 1) The typical time for the output to recover to 1% of the applied pulse is 80ns. To recover to 0.1% requires 860ns. This rapid recovery is due to the wide bandwidth of the output stage and large total GBW.

NO EXTERNAL CAPACITORS REQUIRED

The LMV2011 does not need external capacitors. This eliminates the problems caused by capacitor leakage and dielectric absorption, which can cause delays of several seconds from turn-on until the amplifier's error has settled.

MORE BENEFITS

The LMV2011 offers the benefits mentioned above and more. It has a rail-to-rail output and consumes only $950\mu\text{A}$ of supply current while providing excellent DC and AC electrical performance. In DC performance, the LMC2001 achieves 130dB of CMRR, 120dB of PSRR and 130dB of open loop gain. In AC performance, the LMV2011 provides 3MHz of gain-bandwidth product and $4\text{V}/\mu\text{s}$ of slew rate.

HOW THE LMV2011 WORKS

The LMV2011 uses new, patented techniques to achieve the high DC accuracy traditionally associated with chopper-stabilized amplifiers without the major drawbacks produced by chopping. The LMV2011 continuously monitors the input offset and corrects this error. The conventional chopping process produces many mixing products, both sums and differences, between the chopping frequency and the incoming signal frequency. This mixing causes large amounts of distortion, particularly when the signal frequency approaches the chopping frequency. Even without an incoming signal, the chopper harmonics mix with each other to produce even more trash. If this sounds unlikely or difficult to understand, look at the plot (Figure 2), of the output of a typical (MAX432) chopper-stabilized opamp. This is the output when there is no incoming signal, just the amplifier in a gain of -10 with the input grounded. The chopper is operating at about 150Hz; the rest is mixing products. Add an input signal and the noise gets much worse. Compare this plot with Figure 3 of the LMV2011. This data was taken under the exact same conditions. The auto-zero action is visible at about 30kHz but note the absence of mixing products at other frequencies. As a result, the LMV2011 has very low distortion of 0.02% and very low mixing products.

Application Information (Continued)

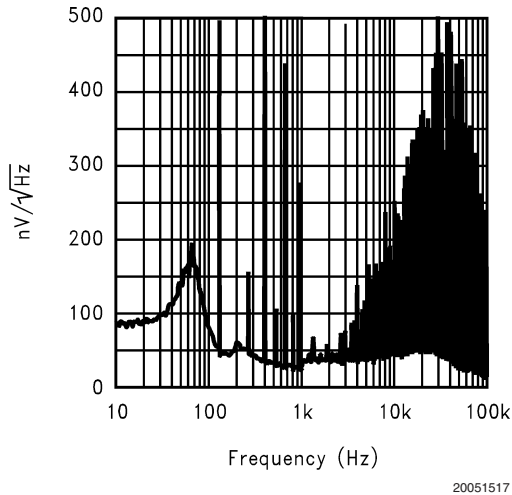

FIGURE 2.

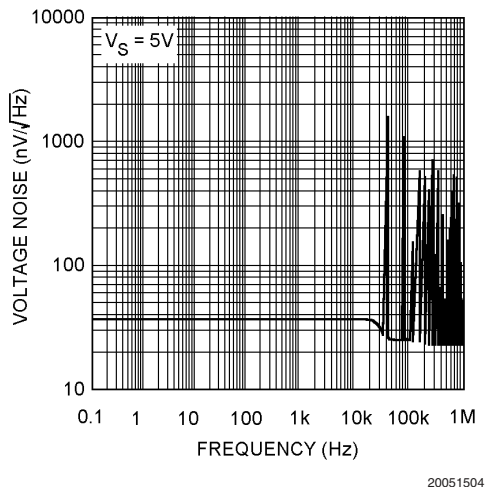

FIGURE 3.

INPUT CURRENTS

The LMV2011's input currents are different than standard bipolar or CMOS input currents in that it appears as a current flowing in one input and out the other. Under most operating conditions, these currents are in the picoamp level and will have little or no effect in most circuits. These currents tend to increase slightly when the common-mode voltage is near the minus supply. (See the typical curves.) At high temperatures such as 85°C, the input currents become larger, 0.5nA typical, and are both positive except when the V_{CM} is near V^- . If operation is expected at low common-mode voltages and high temperature, do not add resistance in series with the inputs to balance the impedances. Doing this can cause an increase in offset voltage. A small resistance such as 1kΩ can provide some protection against very large transients or overloads, and will not increase the offset significantly.

PRECISION STRAIN-GAUGE AMPLIFIER

This Strain-Gauge amplifier (Figure 4) provides high gain (1006 or ~60 dB) with very low offset and drift. Using the resistors' tolerances as shown, the worst case CMRR will be greater than 108 dB. The CMRR is directly related to the resistor mismatch. The rejection of common-mode error, at the output, is independent of the differential gain, which is set by R3. The CMRR is further improved, if the resistor ratio matching is improved, by specifying tighter-tolerance resistors, or by trimming.

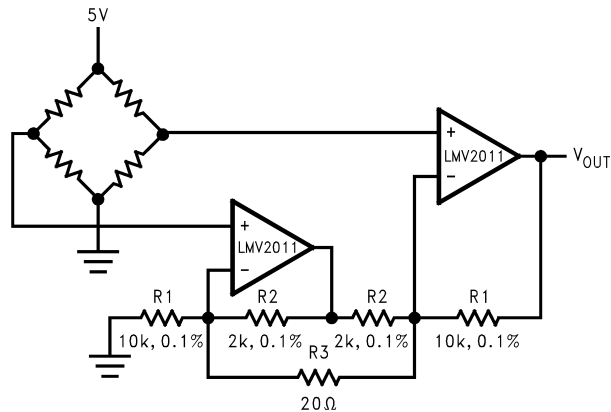

FIGURE 4.

Extending Supply Voltages and Output Swing by Using a Composite Amplifier Configuration:

In cases where substantially higher output swing is required with higher supply voltages, arrangements like the ones shown in *Figure 5* and *Figure 6* could be used. These configurations utilize the excellent DC performance of the LMV2011 while at the same time allow the superior voltage and frequency capabilities of the LM6171 to set the dynamic performance of the overall amplifier. For example, it is possible to achieve $\pm 12V$ output swing with 300MHz of overall GBW ($A_V = 100$) while keeping the worst case output shift due to V_{OS} less than 4mV. The LMV2011 output voltage is kept at about mid-point of its overall supply voltage, and its input common mode voltage range allows the V^- terminal to be grounded in one case (*Figure 5*, inverting operation) and tied to a small non-critical negative bias in another (*Figure 6*, non-inverting operation). Higher closed-loop gains are also possible with a corresponding reduction in realizable bandwidth. Table 1 shows some other closed loop gain possibilities along with the measured performance in each case.

Application Information (Continued)

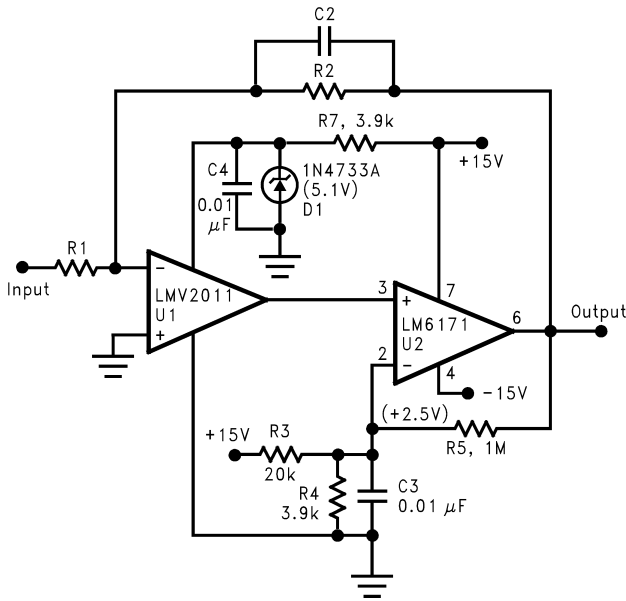

FIGURE 5.

TABLE 1. Composite Amplifier Measured Performance

AV	R1 Ω	R2 Ω	C2 pF	BW MHz	SR (V/μs)	en p-p (mV _{PP})
50	200	10k	8	3.3	178	37
100	100	10k	10	2.5	174	70
100	1k	100k	0.67	3.1	170	70
500	200	100k	1.75	1.4	96	250
1000	100	100k	2.2	0.98	64	400

In terms of the measured output peak-to-peak noise, the following relationship holds between output noise voltage, e_n p-p, for different closed-loop gain, A_v , settings, where -3dB Bandwidth is BW:

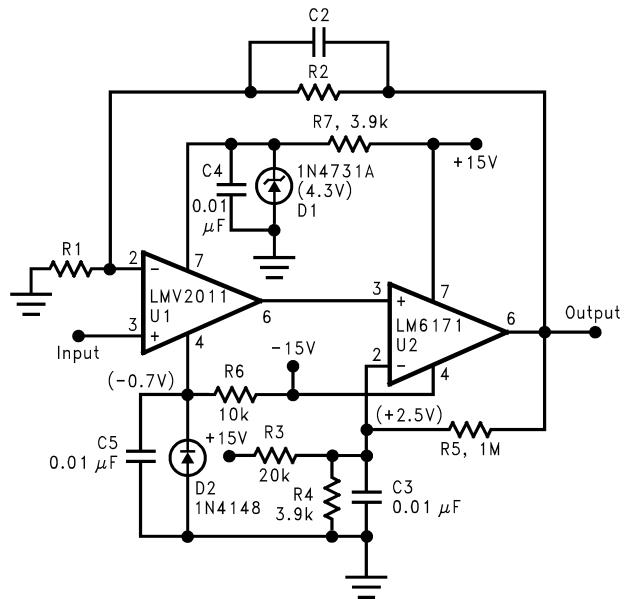

FIGURE 6.

It should be kept in mind that in order to minimize the output noise voltage for a given closed-loop gain setting, one could minimize the overall bandwidth. As can be seen from Equation 1 above, the output noise has a square-root relationship to the Bandwidth.

In the case of the inverting configuration, it is also possible to increase the input impedance of the overall amplifier, by raising the value of R1, without having to increase the feedback resistor, R2, to impractical values, by utilizing a "Tee" network as feedback. See the LMC6442 data sheet (Application Notes section) for more details on this.

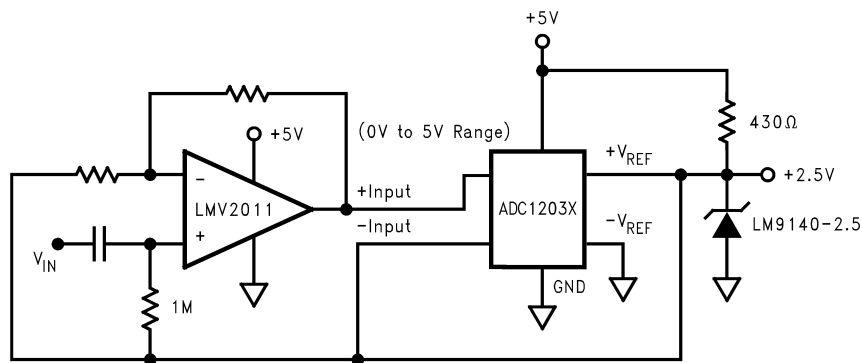

FIGURE 7.

Application Information (Continued)

LMV2011 AS ADC INPUT AMPLIFIER

The LMV2011 is a great choice for an amplifier stage immediately before the input of an ADC (Analog-to-Digital Converter), whether AC or DC coupled. See Figure 7 and Figure 8. This is because of the following important characteristics:

- A) Very low offset voltage and offset voltage drift over time and temperature allow a high closed-loop gain setting without introducing any short-term or long-term errors. For example, when set to a closed-loop gain of 100 as the analog input amplifier for a 12-bit A/D converter, the overall conversion error over full operation temperature and 30 years life of the part (operating at 50°C) would be less than 5 LSBs.
- B) Fast large-signal settling time to 0.01% of final value (1.4µs) allows 12 bit accuracy at 100KHz or more sampling rate.
- C) No flicker (1/f) noise means unsurpassed data accuracy over any measurement period of time, no matter how long. Consider the following opamp performance, based on a typical low-noise, high-performance commercially-available device, for comparison:

Opamp flatband noise = $8\text{nV}/\sqrt{\text{Hz}}$

1/f corner frequency = 100Hz

$A_V = 2000$

Measurement time = 100 sec

Bandwidth = 2Hz

This example will result in about 2.2 mV_{PP} (1.9 LSB) of output noise contribution due to the opamp alone, compared to about 594µV_{PP} (less than 0.5 LSB) when that opamp is replaced with the LMV2011 which has no 1/f contribution. If the measurement time is increased from 100 seconds to 1 hour, the improvement realized by using the LMV2011 would be a factor of about 4.8 times (2.86mV_{PP} compared to 596µV when LMV2011 is used) mainly because the LMV2011 accuracy is not compromised by increasing the observation time.

- D) Copper leadframe construction minimizes any thermocouple effects which would degrade low level/high gain data conversion application accuracy (see discussion under "The Benefits of the LMV2011" section above).
- E) Rail-to-Rail output swing maximizes the ADC dynamic range in 5-Volt single-supply converter applications. Below are some typical block diagrams showing the LMV2011 used as an ADC amplifier (Figure 7 and Figure 8).

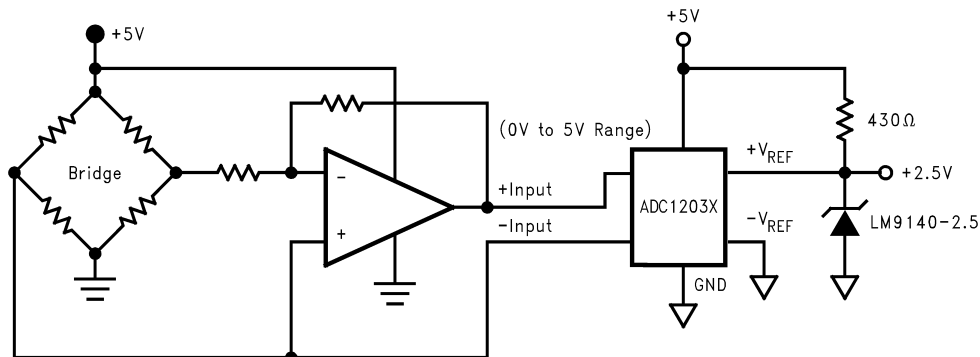

20051522

FIGURE 8.

Physical Dimensions inches (millimeters)

unless otherwise noted

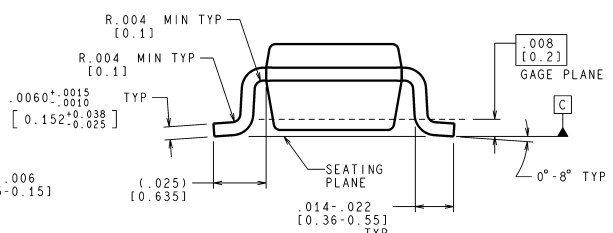
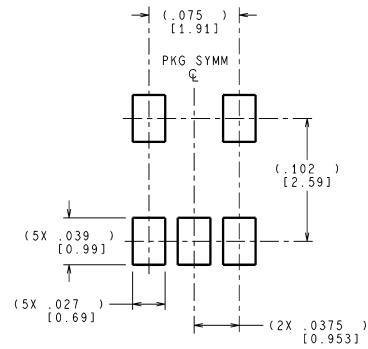
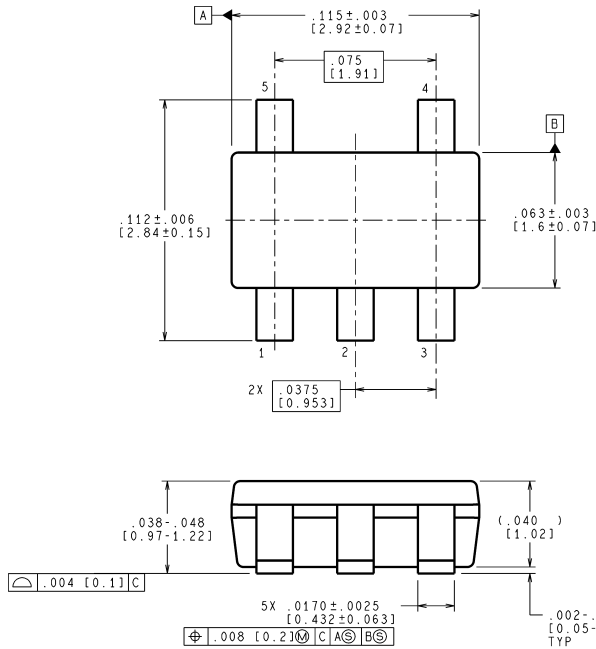

CONTROLLING DIMENSION IS INCH
 VALUES IN [] ARE MILLIMETERS

MF05A (Rev B)

5-Pin SOT23 NS Package Number MF0A5

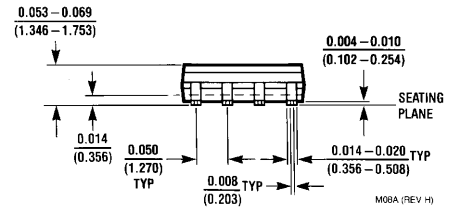
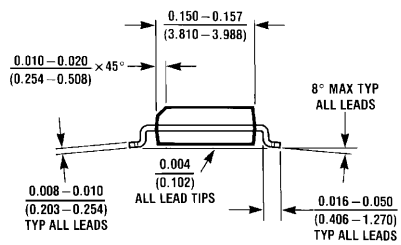
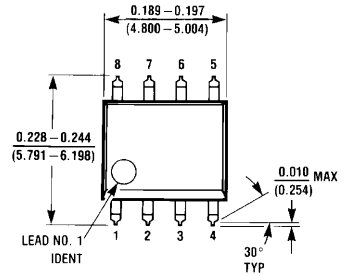

8-Pin SOIC NS Package Number M08A

Notes

LIFE SUPPORT POLICY

NATIONAL'S PRODUCTS ARE NOT AUTHORIZED FOR USE AS CRITICAL COMPONENTS IN LIFE SUPPORT DEVICES OR SYSTEMS WITHOUT THE EXPRESS WRITTEN APPROVAL OF THE PRESIDENT AND GENERAL COUNSEL OF NATIONAL SEMICONDUCTOR CORPORATION. As used herein:

1. Life support devices or systems are devices or systems which, (a) are intended for surgical implant into the body, or (b) support or sustain life, and whose failure to perform when properly used in accordance with instructions for use provided in the labeling, can be reasonably expected to result in a significant injury to the user.
2. A critical component is any component of a life support device or system whose failure to perform can be reasonably expected to cause the failure of the life support device or system, or to affect its safety or effectiveness.



National Semiconductor
Americas Customer
Support Center
Email: new.feedback@nsc.com
Tel: 1-800-272-9959

www.national.com

National Semiconductor
Europe Customer Support Center
Fax: +49 (0) 180-530 85 86
Email: europe.support@nsc.com
Deutsch Tel: +49 (0) 69 9508 6208
English Tel: +44 (0) 870 24 0 2171
Français Tel: +33 (0) 1 41 91 8790

National Semiconductor
Asia Pacific Customer
Support Center
Email: ap.support@nsc.com

National Semiconductor
Japan Customer Support Center
Fax: 81-3-5639-7507
Email: jpn.feedback@nsc.com
Tel: 81-3-5639-7560