

Piezoelectric Sound Components

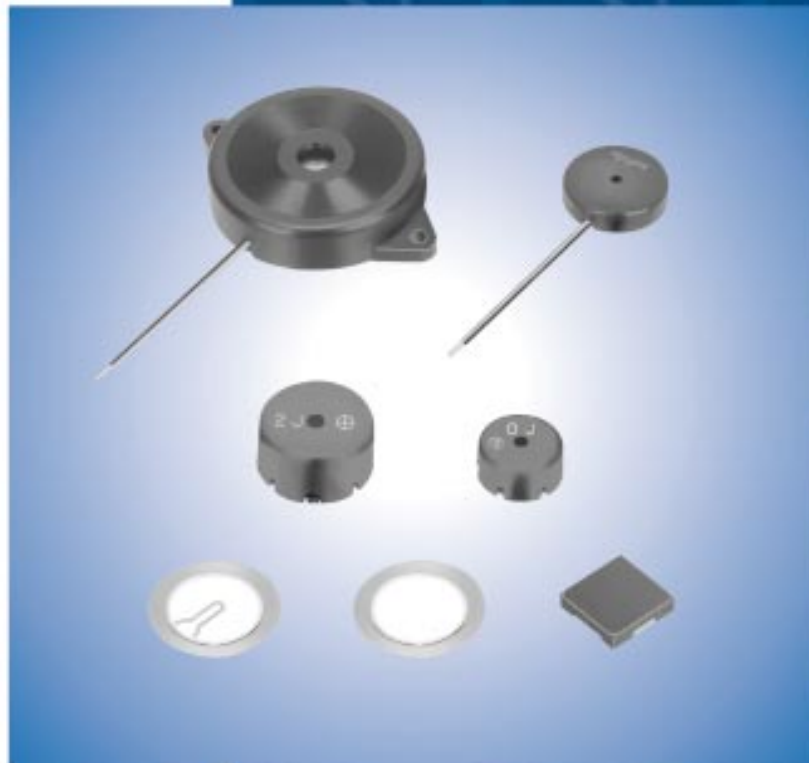

muRata *Innovator
in Electronics*

Murata
Manufacturing Co., Ltd.

Cat.No.P37E-23

for EU RoHS Compliant

- All the products in this catalog comply with EU RoHS.
- EU RoHS is "the European Directive 2002/95/EC on the Restriction of the Use of Certain Hazardous Substances in Electrical and Electronic Equipment".
- For more details, please refer to our website 'Murata's Approach for EU RoHS' (<http://www.murata.com/info/rohs.html>).

CONTENTS

PIEZORINGER® and "PIEZORINGER" in this catalog are the trademarks of Murata Manufacturing Co., Ltd.

Part Numbering	2	1
Application Matrix	4	2
1 Piezoelectric Diaphragms	5	
External Drive Type	5	
Self Drive Type	6	3
● Piezoelectric Diaphragms Notice	7	
2 Piezoelectric Sounders External Drive Pin Type	8	
● Piezoelectric Sounders (External Drive Pin Type) Circuit/Notice	13	
3 Piezoelectric Sounders External Drive Pin Type Taping	14	4
● Piezoelectric Sounders (External Drive Pin Type Taping) Circuit/Notice	16	
4 Piezoelectric Sounders External Drive Lead Wire Type	17	
● Piezoelectric Sounders (External Drive Lead Wire Type) Circuit/Notice	19	5
5 Piezoelectric Sounders External Drive SMD Type	20	
● Piezoelectric Sounders (External Drive SMD Type) Circuit/Notice	22	
6 Piezoelectric Ringers (PIEZORINGER®)	23	6
Pin Type	23	
Lead Wire Type	23	
● Piezoelectric Ringers (PIEZORINGER®) Notice	25	
7 Piezoelectric Sounders Self Drive Pin Type	26	7
● Piezoelectric Sounders (Self Drive) Notice	27	
8 Piezoelectric Buzzers	28	
Pin Type	28	8
Lead Wire Type	28	
● Piezoelectric Buzzers Notice	29	
Piezoelectric Sound Components Notice	30	
Package	31	

● Part Numbering

Piezoelectric Diaphragms

(Part Number)

7	N	B	-31R2	DM	-1R5		L	10
①	②	③	④	⑤	⑥	⑦	⑧	⑨

① Product ID

Product ID	
7	Ceramic Material

② Material

Code	Metal Plate Material
B	Brass
N	Nickel Alloy
S	SUS

③ Product

Code	Product
B	Piezoelectric Diaphragms

④ Metal Plate Diameter

Code	Metal Plate Diameter
-31R2	A hyphen (-) plus four digits alphanumerics express metal plate outer dimensions. A decimal point is expressed by the capital letter "R".

If there is no decimal point, the decimal point code is omitted.

⑤ Form of Piezoelectric Style

Code	Form of Piezoelectric Style
DM	Two digits express shape of ceramics.

For an Ag electrode, this digit remains blank, the corresponding code is omitted.

⑥ Resonant Frequency Type

Code	Resonant Frequency (kHz)
-1R5	A hyphen (-) and three digits alphanumerics express resonant frequency. A decimal point is expressed by the capital letter "R".

If there is no decimal point, the decimal point is omitted.

⑦ With Feedback Electrode

Code	With Feedback Electrode
C	With Feedback Electrode
-	Without Feedback Electrode

⑧ Product Specification

Code	Product Specification
L	With lead (available for RoHS)
-	No lead (omitted)

⑨ Individual Specification Code

Code	Individual Specification Code
10	These digits express a lead length, lead number, and presence/absence of a connector.

If the product has no individual specification, the corresponding code is omitted.

Piezoelectric Sounders/Piezoelectric Buzzers/Piezoelectric Ringers (PIEZORINGER®)

(Part Number)

PK	M	13	E	P	YH	40	00	P	-A0
①	②	③	④	⑤	⑥	⑦	⑧	⑨	⑩

① Product ID

Product ID	
PK	Piezoelectric Sound Components

② Product

Code	Product
M	Sounder, Ringer
B	Buzzer

③ Outer Dimensions

Expressed by two figures in mm.

Ex.)

Code	Outer Dimensions
13	ø12.6mm

④ Drive

Code	Drive
E	External-Drive
S	Self-Drive

⑤ Outer Electrode Style

Code	Outer Electrode Style
P	Pin Type
W	Lead Wire Type

⑥ Structure

Code	Structure
T□	Standing Type
P□	Flat Type Auto-assemble
Y□	Flat Type/Available for Taping
C□	Flat Type/Semi-auto-assemble
□	Exclude above mentioned

□ means specification of outer electrode.

SMD Piezoelectric Sounder

(Part Number)

PK	LCS	1212	E	40	01	-R1
①	②	③	④	⑤	⑥	⑦

① Product ID

Product ID	
PK	Piezoelectric Sound Components

② Product

Code	Product
LCS	SMD Sounder

③ Dimensions

Code	Outer Dimensions
1212	□12mm

④ Drive

Code	Drive
E	External Drive

⑦ Oscillating Frequency Type

Code	Oscillating Frequency Type
40	Expressed resonant frequency by two-digit alphanumerics. The unit is in 100 hertz (Hz). In case of 4kHz (4000Hz), expressed as "40".

⑧ Individual Specification Code

Code	Individual Specification Code
00	Two digits express custom specification in characteristics.

⑨ Special Quality Guarantee

Code	Special Quality Guarantee
P	Post Plated Terminal
-	Blank

⑩ Packaging

Code	Packaging
-B0	Bulk
-A0	Radial Taping
-M0	Magazine

Radial taping or magazines are not available for all types. Please contact us.

Packaging Code is blank in the case of types for which radial taping or magazines are not available.

⑤ Oscillating Frequency Type

Code	Oscillating Frequency Type
40	Expressed resonant frequency by two-digit alphanumerics. The unit is in 100 hertz (Hz). In case of 4kHz (4000Hz), expressed as "40".

⑥ Individual Specification Code

Code	Individual Specification Code
01	Two digits express specific specification in characteristics.

⑦ Packaging

Code	Packaging
-R1	Plastic taping

Application Matrix

		Application	Tele- phone	Watch	Clock	Medical Equip- ment	Fire/ Gas Alarm	Digital Camera	Toy	Bar Code Scanner	Printer	Note- PC PDA	DVD- Player	Micro- wave Oven	Air Condi- tioner	Fan Heater	Instru- ment Cluster	
		Part Number																
Piezoelectric Diaphragm	External Drive Type	7BB-12-9		●	●	●		●	●			●						
		7BB-15-6			●	●		●	●			●						
		7BB-20-3	●	●	●	●	●		●	●	●							
		7BB-20-6			●	●			●	●			●					
		7BB-20-6L0			●	●			●	●			●					
		7BB-27-4	●		●	●			●	●	●							
		7BB-27-4L0	●		●	●			●	●	●							
		7BB-35-3	●		●				●	●	●							
		7BB-35-3L0	●		●			●	●	●	●							
		7BB-41-2	●															
		7BB-41-2L0	●															
	7NB-31R2-1					●	●											
	Self Drive Type	7BB-20-6C	●						●	●								
		7BB-20-6CL0	●						●	●								
		7BB-27-4C	●					●		●	●							
		7BB-27-4CL0	●					●		●	●							
		7BB-35-3C	●					●		●	●							
		7BB-35-3CL0	●					●		●	●							
		7BB-41-2C	●															
		7BB-41-2CL0	●															
7SB-34R7-3C						●												
Piezoelectric Sounder	External Drive Type	PKM13EPYH4000-A0	●		●	●		●	●	●	●	●	●		●	●	●	
		PKM13EPYH4002-B0	●		●	●			●	●	●	●	●	●	●	●	●	●
		PKM17EPP-2002-B0	●		●	●			●	●	●	●	●	●	●	●	●	●
		PKM17EPPH4001-B0	●		●	●			●	●	●	●	●	●	●	●	●	●
		PKM17EWH2001	●		●	●			●	●	●	●	●	●	●	●	●	●
		PKM22EPH2001								●		●		●	●	●	●	●
		PKM22EPPH2001-B0	●		●	●				●		●		●	●	●	●	●
		PKM22EPPH4001-B0	●		●	●				●		●		●	●	●	●	●
		PKM22EPPH4005-B0	●		●	●				●		●		●	●	●	●	●
		PKM22EPPH4007-B0	●		●	●	●			●		●		●	●	●	●	●
		PKM22EPTH2001-B0								●		●		●	●	●	●	
		PKM17EWH4000	●		●	●			●	●	●	●	●	●	●	●	●	●
		PKLCS1212E2000-R1	●			●			●	●	●	●	●			●		
		PKLCS1212E20A0-R1																●
	PKLCS1212E4001-R1	●			●			●	●	●	●	●			●			
	PKLCS1212E40A1-R1																●	
Self Drive Type	PKM24SPH3805	●					●		●					●	●	●		
	PKM30SPH2001-B0								●		●	●		●				
	PKM30SPH2501-B0								●		●	●						
Piezoelectric Buzzer	PKB24SPCH3601-B0	●			●				●		●	●	●		●	●		
	PKB24SWH3301	●		●					●		●	●		●	●	●		
Piezoelectric Ringer	PKM33EPH1201C	●																
	PKM34EWH1101C	●																
	PKM34EWH1201C	●																
	PKM44EWH1001C	●																

There are various applications besides those listed in the above table, including:

Burglar Alarm, Laundry Machine, Bath, Interphone, Chime, Back Buzzer, ME Instruments, Measuring Instruments, Vending Machine, Calculator, Automobile, Communication Radio, Hemodynamometer, Thermometer, Running Meter, Facsimile, Audio Timer, Automatic Controlling Devices.

Piezoelectric Sound Components



1

Piezoelectric Diaphragms

■ Features

1. Clear sound
2. Ultra thin and lightweight
3. No contacts: therefore, no noise and highly reliable
4. Low power consumption for voltage type

■ Applications

Clocks/Calculators/Digital camera/Various alarms
(Burglar alarms, etc.)

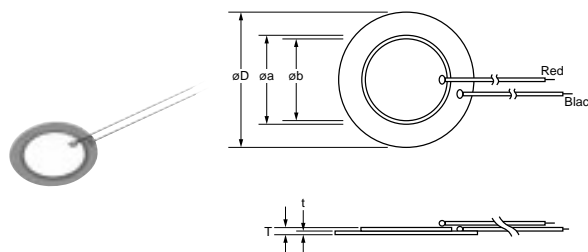

External Drive Type

Part Number	Resonant Frequency (kHz)	Resonant Impedance (ohm)	Capacitance (nF)	Plate Size dia. D (mm)	Element Size dia. a (mm)	Electrode Size dia. b (mm)	Thickness T (mm)	Plate Thickness t (mm)	Plate Material
7BB-12-9	9.0 ±1.0kHz	1000 max.	8.0 ±30% [1kHz]	12.0	9.0	8.0	0.22	0.10	Brass
7BB-15-6	6.0 ±1.0kHz	800 max.	10.0 ±30% [1kHz]	15.0	10.0	9.0	0.22	0.10	Brass
7BB-20-3	3.6 ±0.6kHz	500 max.	20.0 ±30% [1kHz]	20.0	14.0	12.8	0.22	0.10	Brass
7BB-20-6	6.3 ±0.6kHz	350 max.	10.0 ±30% [1kHz]	20.0	14.0	12.8	0.42	0.20	Brass
7BB-20-6L0	6.3 ±0.6kHz	1000 max.	10.0 ±30% [1kHz]	20.0	14.0	12.8	0.42	0.20	Brass (with Lead Wire: AWG32 Length 50mm)
7BB-27-4	4.6 ±0.5kHz	200 max.	20.0 ±30% [1kHz]	27.0	19.7	18.2	0.54	0.30	Brass
7BB-27-4L0	4.6 ±0.5kHz	300 max.	20.0 ±30% [1kHz]	27.0	19.7	18.2	0.54	0.30	Brass (with Lead Wire: AWG32 Length 50mm)
7BB-35-3	2.8 ±0.5kHz	200 max.	30.0 ±30% [1kHz]	35.0	25.0	23.0	0.53	0.30	Brass
7BB-35-3L0	2.8 ±0.5kHz	200 max.	30.0 ±30% [1kHz]	35.0	25.0	23.0	0.53	0.30	Brass (with Lead Wire: AWG32 Length 50mm)
7BB-41-2	2.2 ±0.3kHz	250 max.	30.0 ±30% [1kHz]	41.0	25.0	23.0	0.63	0.40	Brass
7BB-41-2L0	2.2 ±0.3kHz	300 max.	30.0 ±30% [1kHz]	41.0	25.0	23.0	0.63	0.40	Brass (with Lead Wire: AWG32 Length 50mm)
7NB-31R2-1	1.3 ±0.5kHz	300 max.	40.0 ±30% [120Hz]	31.2	19.7	18.2	0.22	0.10	Nickel Alloy

1

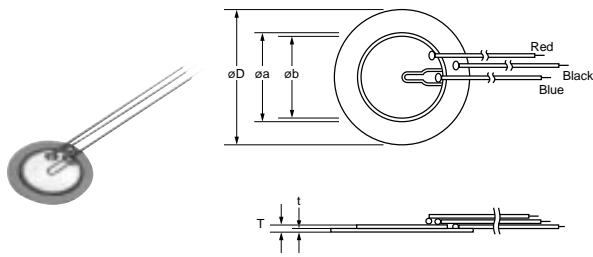

Self Drive Type

Part Number	Resonant Frequency (kHz)	Resonant Impedance (ohm)	Capacitance (nF)	Plate Size dia. D (mm)	Element Size dia. a (mm)	Electrode Size dia. b (mm)	Thickness T (mm)	Plate Thickness t (mm)	Plate Material
7BB-20-6C	6.3 ±0.6kHz	500 max.	8.5 ±30% [1kHz]	20.0	14.0	12.8	0.42	0.20	Brass
7BB-20-6CL0	6.3 ±0.6kHz	800 max.	8.5 ±30% [1kHz]	20.0	14.0	12.8	0.42	0.20	Brass (with Lead Wire: AWG32 Length 50mm)
7BB-27-4C	4.6 ±0.5kHz	200 max.	18.0 ±30% [1kHz]	27.0	19.7	18.2	0.54	0.30	Brass
7BB-27-4CL0	4.6 ±0.5kHz	350 max.	18.0 ±30% [1kHz]	27.0	19.7	18.2	0.54	0.30	Brass (with Lead Wire: AWG32 Length 50mm)
7BB-35-3C	2.8 ±0.5kHz	200 max.	26.0 ±30% [1kHz]	35.0	25.0	23.0	0.53	0.30	Brass
7BB-35-3CL0	2.8 ±0.5kHz	200 max.	26.0 ±30% [1kHz]	35.0	25.0	23.0	0.53	0.30	Brass (with Lead Wire: AWG32 Length 50mm)
7BB-41-2C	2.2 ±0.3kHz	250 max.	24.0 ±30% [1kHz]	41.0	25.0	23.0	0.63	0.40	Brass
7BB-41-2CL0	2.2 ±0.3kHz	350 max.	24.0 ±30% [1kHz]	41.0	25.0	23.0	0.63	0.40	Brass (with Lead Wire: AWG32 Length 50mm)
7SB-34R7-3C	3.1 ±0.3kHz	150 max.	24.0 ±30% [1kHz]	34.7	25.0	23.4	0.50	0.25	Stainless

■ Node Diameter

Part Number	Node Diameter (mm)
7BB-20-6C	φ13.5
7BB-27-4C	φ17.5
7BB-35-3C	φ22.5
7BB-41-2C	φ26.5

• Sound diaphragms without feedback electrode also have the same node diameters.

Piezoelectric Diaphragms Notice

1

■ Notice (Soldering and Mounting)

1. Applying load on the center area of the diaphragm may cause cracking in the ceramic element. When the diaphragm is supported by the edge, the load should be applied only around the edge.
2. Please consult with Murata or Murata representative if soldering of the component is needed.

■ Notice (Handling)

1. Please do not touch the component with bare hand because electrode may be corroded.
2. The component may be damaged if mechanical stress exceeding specifications is applied.
3. Take care to protect operating circuit from surge voltage resulting from excessive force, falling, shock or temperature change.
4. If DC voltage is applied to the component, silver migration may occur. Please pay full attention to avoid subjecting the component to DC voltage for long periods.
5. The resistor should be used as shown in Fig. A. A suitable resistance value should be chosen, preferably $1\text{k}\Omega$ to $2\text{k}\Omega$. Instead of this measure, a diode may also be applied as shown in Fig. B.

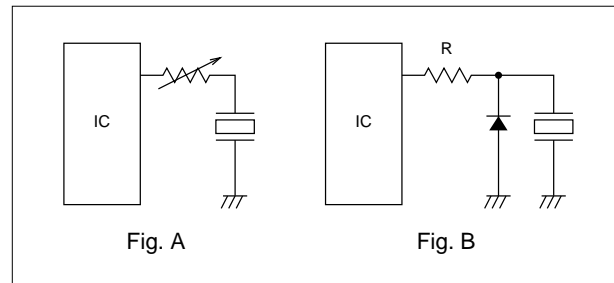

6. Avoid excessive pulling of lead wire because wire may break or soldering point may come off.

Piezoelectric Sound Components



Piezoelectric Sounders External Drive Pin Type

2

Microcomputers are widely used for microwave ovens, air conditioners, cars, toys, timers, and other alarm equipment. Externally driven piezoelectric sounders are used in digital watches, electronic calculators, telephones and other equipment. They are driven by a signal (ex.: 2048Hz or 4096Hz) from an LSI and provide melodious sound.

■ Features

1. Low power consumption
2. No contacts therefore, no noise and highly reliable

■ Applications

1. Various office equipment such as PPCs, printers and keyboards
2. Various home appliances such as microwave ovens
3. Confirmation sound of various audio equipment



PKM13EPYH4002-B0

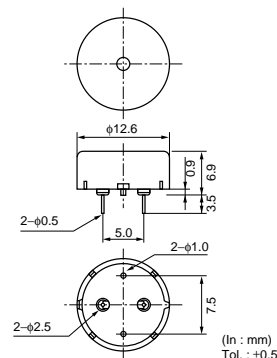

PKM17EPP-2002-B0

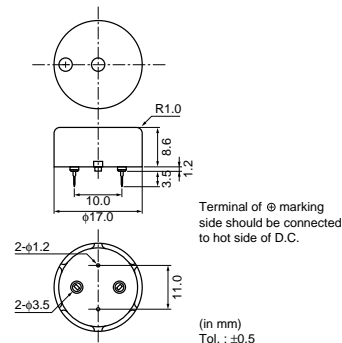

PKM17EPPH4001-B0

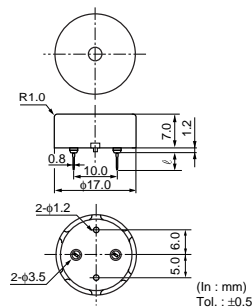

Part Number	ℓ
PKM17EPPH4001-B0	6.5
PKM17EPPH4002-B0	3.5



PKM22EPH2001

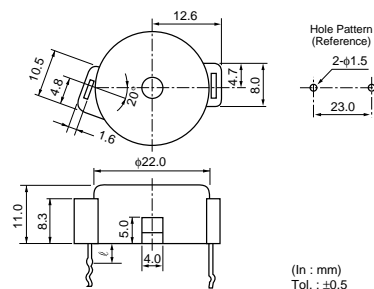

Part Number	ℓ
PKM22EPH2001	4.0
PKM22EPH2002	8.0
PKM22EPH2003	12.0



PKM22EPPH2001-B0

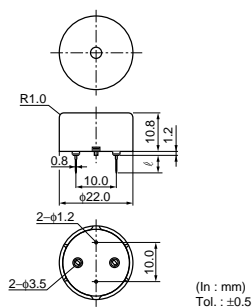

Part Number	ℓ
PKM22EPPH2001-B0	6.5
PKM22EPPH2002-B0	3.5



PKM22EPPH4001-B0

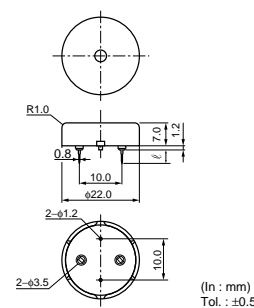

Part Number	ℓ
PKM22EPPH4001-B0	6.5
PKM22EPPH4002-B0	3.5

Continued on the following page.

Continued from the preceding page.



PKM22EPPH4005-B0

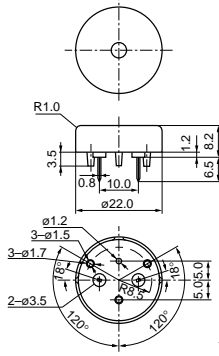

(In : mm)
Tol. : ±0.5



PKM22EPPH4007-B0

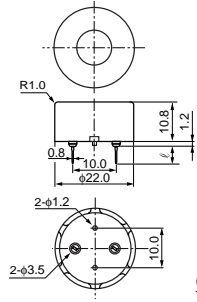

(In : mm)
Tol. : ±0.5

Part Number	ℓ
PKM22EPPH4007-B0	6.5
PKM22EPPH4012-B0	3.5



PKM22EPTH2001-B0

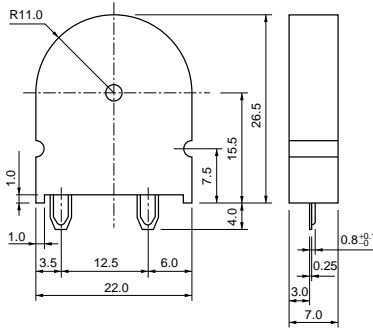

(in mm)
Tol. : ±0.5

Part Number	Sound Pressure Level (dB)	Sound Pressure Level (Ref. only) (dB)	Operating Voltage Range	Capacitance (nF)	Operating Temp. Range (°C)	Storage Temp. Range (°C)
PKM13EPYH4002-B0	70 min. [3Vp-p, 4kHz, square wave, 10cm]	70 min. [1Vrms, 4kHz, sine wave, 10cm]	30.0 Vp-p max.	5.5 ±30% [1kHz]	-40 to +85	-40 to +85
PKM17EPP-2002-B0	70 min. [3Vo-p, 2kHz, square wave, 10cm]	70 min. [1Vrms, 2kHz, sine wave, 10cm]	25.0 Vo-p max. [with polarity]	34.0 ±30% [120Hz]	-20 to +70	-30 to +80
PKM17EPPH4001-B0	72 min. [3Vp-p, 4kHz, square wave, 10cm]	72 min. [1Vrms, 4kHz, sine wave, 10cm]	25.0 Vp-p max.	7.0 ±30% [1kHz]	-20 to +70	-30 to +80
PKM22EPH2001	75 min. [3Vp-p, 2kHz, square wave, 10cm]	75 min. [1Vrms, 2kHz, sine wave, 10cm]	25.0 Vp-p max.	17.0 ±30% [120Hz]	-20 to +70	-30 to +80
PKM22EPPH2001-B0	70 min. [3Vp-p, 2kHz, square wave, 10cm]	70 min. [1Vrms, 2kHz, sine wave, 10cm]	30.0 Vp-p max.	19.0 ±30% [120Hz]	-20 to +70	-30 to +80
PKM22EPPH4001-B0	75 min. [3Vp-p, 4kHz, square wave, 10cm]	75 min. [1Vrms, 4kHz, sine wave, 10cm]	30.0 Vp-p max.	12.0 ±30% [1kHz]	-20 to +70	-30 to +80
PKM22EPPH4005-B0	75 min. [3Vp-p, 4kHz, square wave, 10cm]	75 min. [1Vrms, 4kHz, sine wave, 10cm]	30.0 Vp-p max.	12.0 ±30% [1kHz]	-20 to +70	-30 to +80
PKM22EPPH4007-B0	85 min. [3Vp-p, 4kHz, square wave, 10cm]	85 min. [1Vrms, 4kHz, sine wave, 10cm]	30.0 Vp-p max.	12.0 ±30% [1kHz]	-20 to +70	-30 to +80
PKM22EPTH2001-B0	70 min. [3Vp-p, 2kHz, square wave, 10cm]	70 min. [1Vrms, 2kHz, sine wave, 10cm]	25.0 Vp-p max.	19.0 ±30% [120Hz]	-20 to +70	-30 to +80

■ Freq. Response (Square Wave 3Vp-p, 10cm)

PKM13EPYH4002-B0

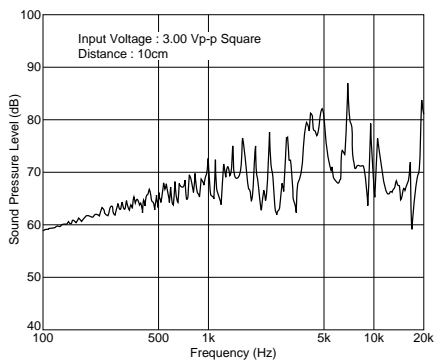

PKM17EPP-2002-B0

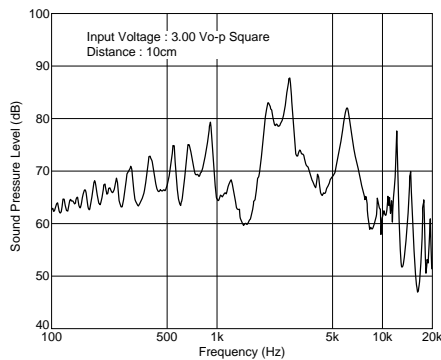

PKM17EPPH4001-B0

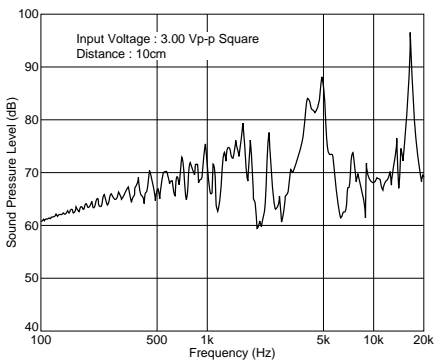

PKM22EPH2001

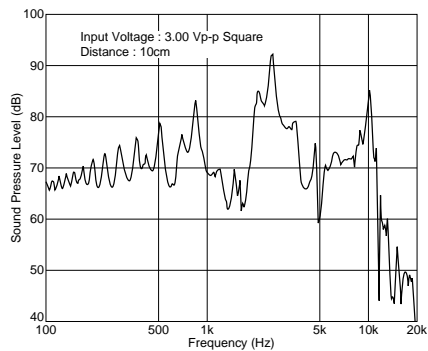

PKM22EPPH2001-B0

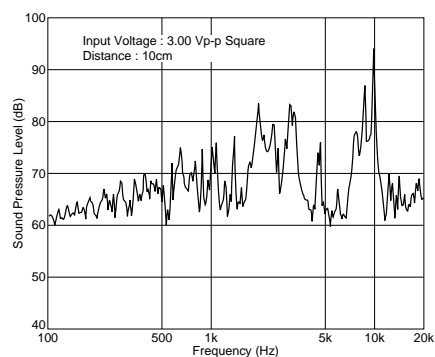

PKM22EPPH4001-B0

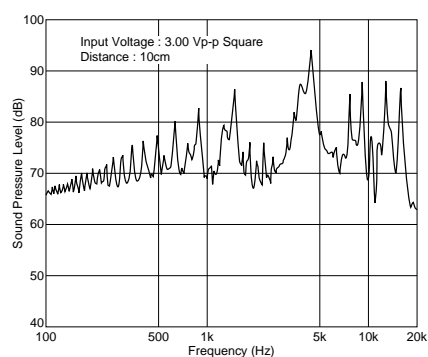

PKM22EPPH4005-B0

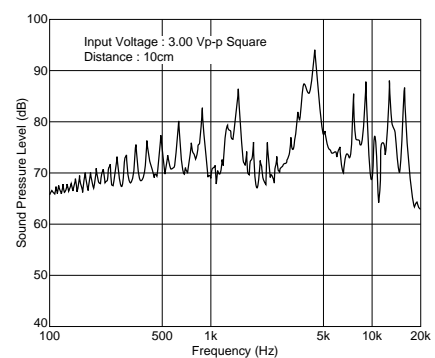

PKM22EPPH4007-B0

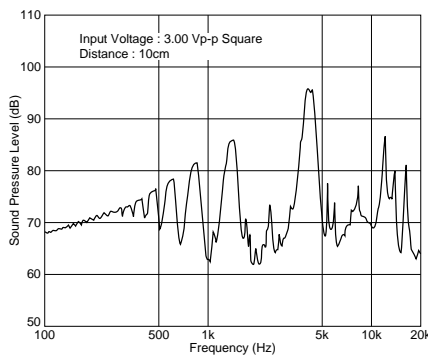

Continued from the preceding page.

■ Freq. Response (Square Wave 3Vp-p, 10cm)

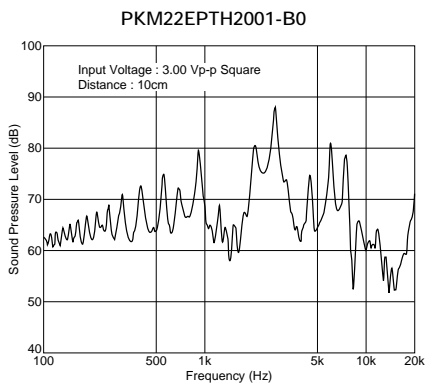

■ Freq. Response (Sine Wave 1Vrms, 10cm)

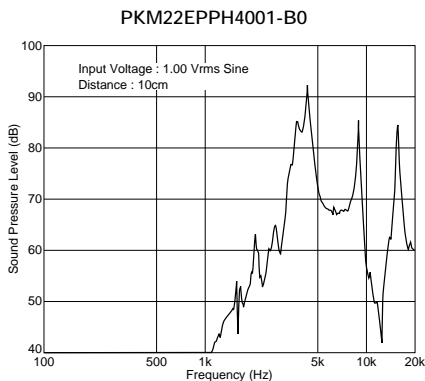
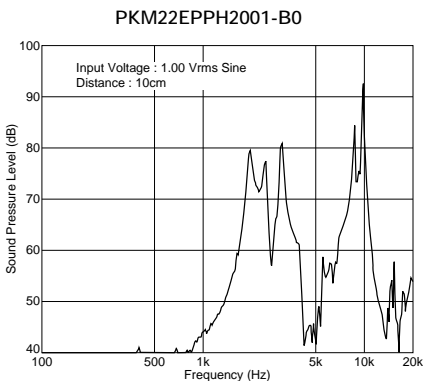
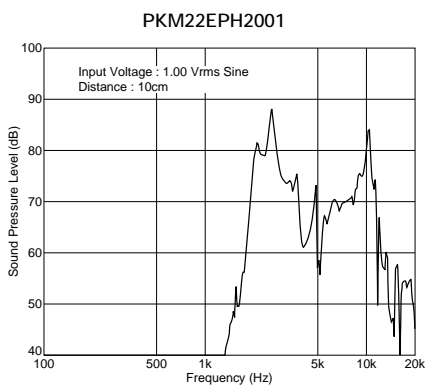
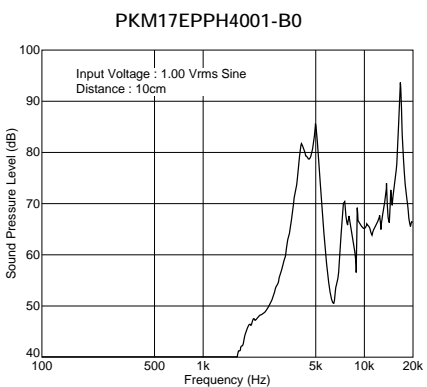
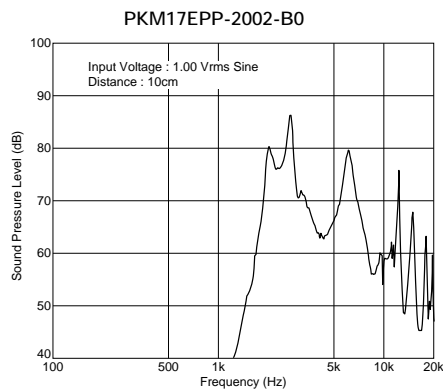
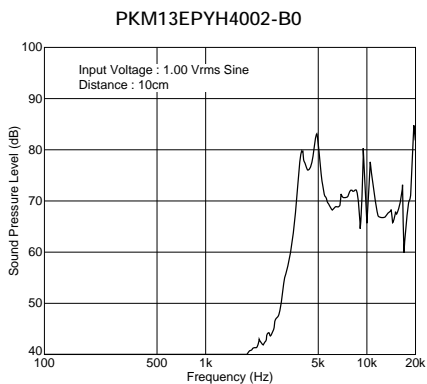

Continued from the preceding page.

■ Freq. Response (Sine Wave 1Vrms, 10cm)

PKM22EPPH4005-B0

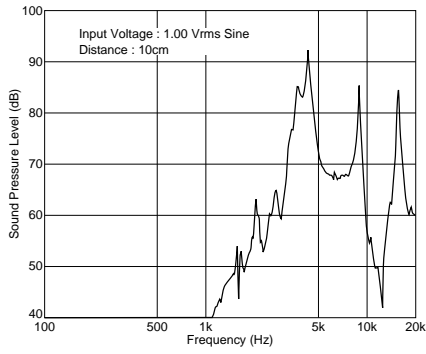

PKM22EPPH4007-B0

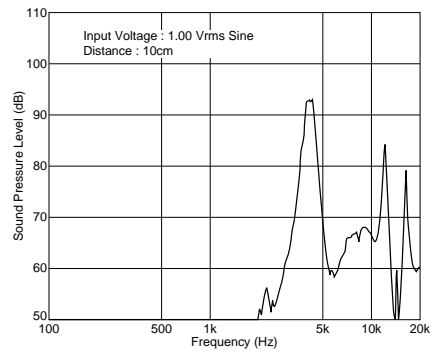

PKM22EPTH2001-B0

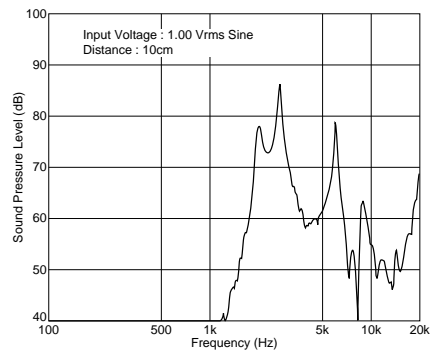

Piezoelectric Sounders (External Drive Pin Type) Circuit/Notice

■ Circuit

The following are examples of externally driven circuits.

- (1) Unstable multi-vibrator using Tr.
- (2) Circuits using inverters or NAND gates.

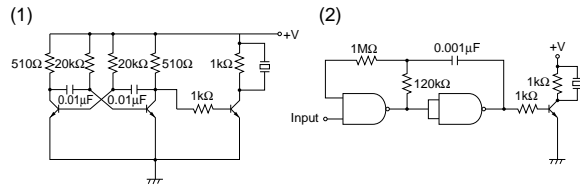

2

■ Notice (Soldering and Mounting)

1. Notice (Soldering and Mounting)

(1) Soldering Iron

- (a) Lead terminals are immersed up to 1.5mm from components body in soldering bath of +260+/-5 degrees C for 10+/-1.0 seconds, and then components shall be left in natural condition for 4 hours.
- (b) Lead terminal is directly contacted with the tip of soldering iron of +350+/-0.5 seconds, and then components shall be left in natural condition for 4 hours.

(2) Reflow

The component cannot withstand reflow soldering.

2. Washing of the component is not acceptable.

Because it is not sealed.

3. For Part Numbers mentioned below, please do not insert the component on double sided PCB with plated through hole. When melted solder touches to the base of lead terminal, a part of plastic case shall be melted and it may cause electrical failure.

• Part Number

PKM13EPYH4002-B0/PKM17EPP-2002-B0
 PKM17EPPH4001-B0/PKM22EPPH2001-B0
 PKM22EPPH4001-B0/PKM22EPPH4007-B0

■ Notice (Handling)

1. The component may be damaged if mechanical stress exceeding specifications is applied.
2. Take care to protect operating circuit from surge voltage resulting from excessive force, falling, shock or temperature change.
3. If DC voltage is applied to the component, silver migration may occur. Please pay full attention to avoid subjecting the component to DC voltage for long periods.
4. The resistor should be used as shown in Fig. A. A suitable resistance value should be chosen, preferably 1kΩ to 2kΩ. Instead of this measure, a diode may also be applied as shown in Fig. B.

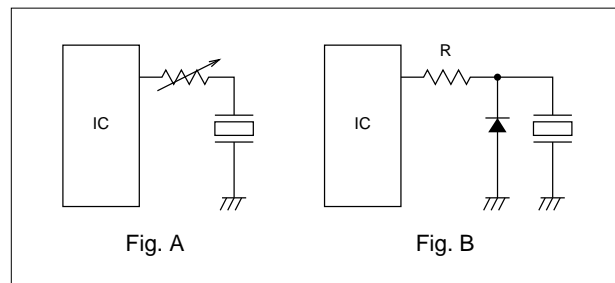

5. Avoid excessive pulling of lead wire because wire may break or soldering point may come off.

Piezoelectric Sound Components



Piezoelectric Sounders External Drive Pin Type Taping

Taking advantage of extensive automatic insertion design technology and materials experience, Murata has developed standard taping type piezoelectric sounders. This Murata technology supports labor and cost saving activities.

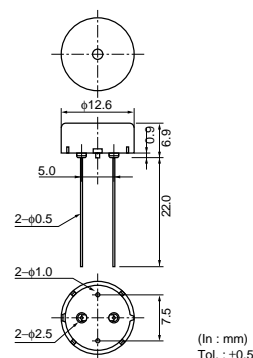
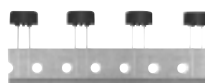

3

■ Features

1. Lead dimension: Improved mouting reliability (cut & clinch) due to round terminal
2. High and stable mountability
3. Ammo packaging

Part Number	Sound Pressure Level (dB)	Sound Pressure Level (Ref. only) (dB)	Operating Voltage Range	Capacitance (nF)	Operating Temp. Range (°C)	Storage Temp. Range (°C)
PKM13EPYH4000-A0	70 min. [3Vp-p,4kHz,square wave,10cm]	70 min. [1Vrms,4kHz,sine wave,10cm]	30.0 Vp-p max.	5.5 ±30% [1kHz]	-40 to +85	-40 to +85

■ Freq. Response (Square Wave 3Vp-p, 10cm)

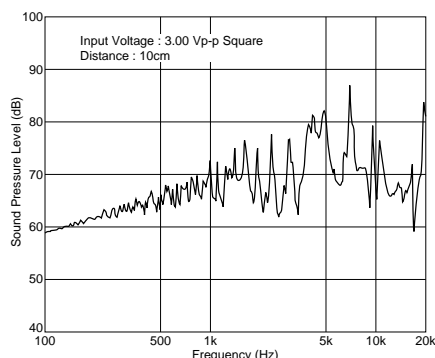

■ Freq. Response (Sine Wave 1Vrms, 10cm)

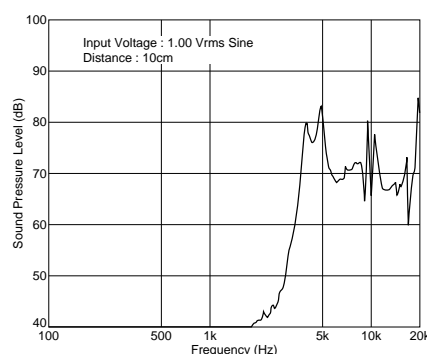

Continued on the following page. ↗

Continued from the preceding page.

■ Taping Dimension

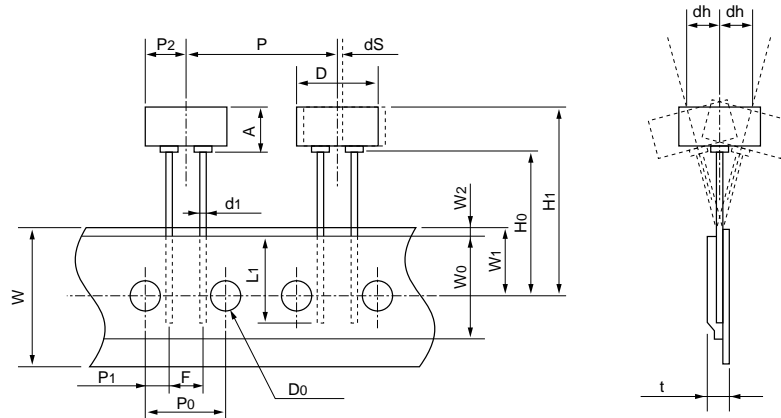

Item	Code	Nominal Value	Tol.	Remarks
Width of diameter	D	ø12.6	±0.5	
Height of component	A	6.9	±0.5	
Dimensions of terminal	d1	ø0.5	±0.1	
Lead length under the hold down tape	L1	8.0 min.	—	
Pitch of component	P	25.4	±0.5	
Pitch of sprocket	P0	12.7	±0.2	Tolerance for Pitches 10XP0=127±2mm
Length from hole center to lead	P1	3.85	±0.7	
Length from hole center to component center	P2	6.35	±0.7	
Lead spacing	F	5.0	±0.5	
Slant forward or backward	dh	0	±1.0	360° : 1mm max.
Width of carrier tape	W	18.0	±0.5	
Width of hold down tape	W0	12.5 min.	—	Hold down tape does not exceed the carrier tape.
Position of sprocket hole	W1	9.0	±0.5	
Gap of hold down tape and carrier tape	W2	2.0 max.	—	
Distance between the center of sprocket hole and lead stopper	H0	18.0	±0.5	
Total height of component	H1	26.0 max.	—	
Diameter of sprocket hole	D0	ø4.0	±0.2	
Total thickness of tape	t	0.6	±0.2	
Body tilt	dS	0	±1.0	

(in mm)

Piezoelectric Sounders (External Drive Pin Type Taping) Circuit/Notice

■ Circuit

The following are examples of externally driven circuits.

- (1) Unstable multi-vibrator using Tr.
- (2) Circuits using inverters or NAND gates.

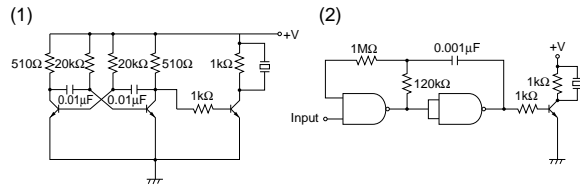

3

■ Notice (Soldering and Mounting)

1. Notice (Soldering and Mounting)

(1) Soldering Iron

- (a) Lead terminals are immersed up to 1.5mm from components body in soldering bath of +260+/-5 degrees C for 10+/-1.0 seconds, and then components shall be left in natural condition for 4 hours.
- (b) Lead terminal is directly contacted with the tip of soldering iron of +350+/-0.5 seconds, and then components shall be left in natural condition for 4 hours.

(2) Reflow

The component cannot withstand reflow soldering.

2. Please do not insert the component on double sided PCB with plated through hole. When melted solder touches to the base of lead terminal, a part of plastic case shall be melted and it may cause electrical failure.
3. Washing of the component is not acceptable. Because it is not sealed.

■ Notice (Handling)

1. The component may be damaged if mechanical stress exceeding specifications is applied.
2. Take care to protect operating circuit from surge voltage resulting from excessive force, falling, shock or temperature change.
3. If DC voltage is applied to the component, silver migration may occur. Please pay full attention to avoid subjecting the component to DC voltage for long periods.
4. The resistor should be used as shown in Fig. A. A suitable resistance value should be chosen, preferably 1kΩ to 2kΩ. Instead of this measure, a diode may also be applied as shown in Fig. B.

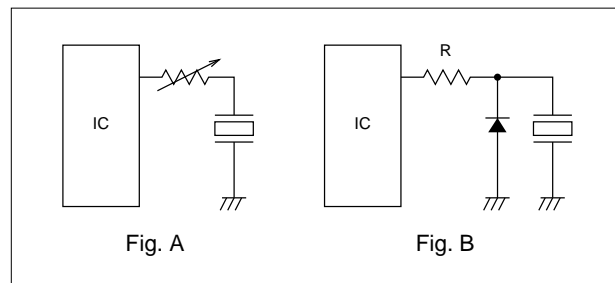

5. Avoid excessive pulling of lead wire because wire may break or soldering point may come off.

Piezoelectric Sound Components



Piezoelectric Sounders External Drive Lead Wire Type

Microcomputers are widely used for microwave ovens, air conditioners, cars, toys, timers, and other alarm equipment. Externally driven piezoelectric sounders are used in digital watches, electronic calculators, telephones and other equipment. They are driven by a signal (ex.: 2048Hz or 4096Hz) from an LSI and provide melodious sound.

■ Features

1. Low power consumption
2. No contacts therefore, no noise and highly reliable

■ Applications

1. Various office equipment such as PPCs, printers and keyboards
2. Various home appliances such as microwave ovens
3. Confirmation sound of various audio equipment



PKM17EWH2001

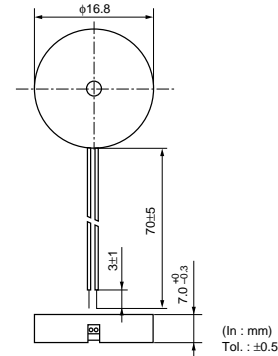

PKM17EWH4000

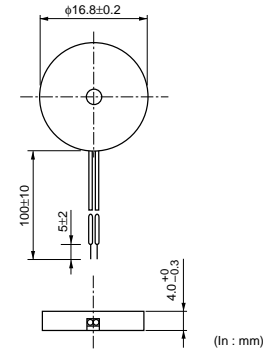

4

Part Number	Sound Pressure Level (dB)	Sound Pressure Level (Ref. only) (dB)	Operating Voltage Range	Capacitance (nF)	Operating Temp. Range (°C)	Storage Temp. Range (°C)
PKM17EWH2001	72 min. [3Vp-p, 2kHz, square wave, 10cm]	70 min. [1Vrms, 2kHz, sine wave, 10cm]	7.0 Vp-p max.	40.0 ±30% [120Hz]	-20 to +70	-30 to +80
PKM17EWH4000	75 min. [3Vp-p, 4kHz, square wave, 10cm]	70 min. [1Vrms, 4kHz, sine wave, 10cm]	25.0 Vp-p max.	9.5 ±30% [1kHz]	-20 to +70	-30 to +80

■ Freq. Response (Square Wave 3Vp-p, 10cm)

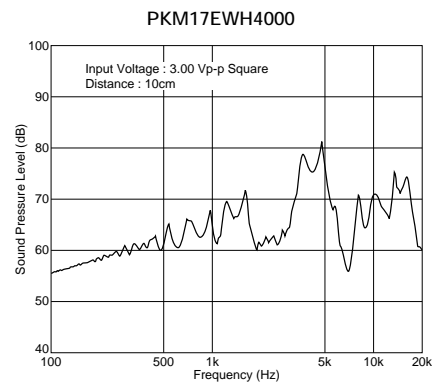
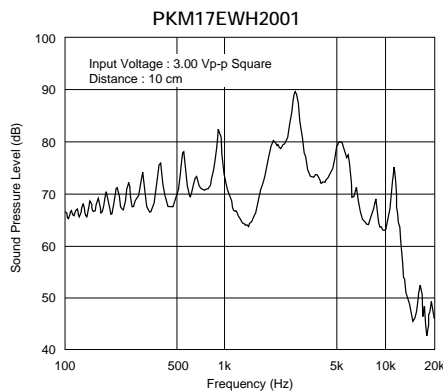

Continued on the following page. ↗

Continued from the preceding page.

■ Freq. Response (Sine Wave 1Vrms, 10cm)

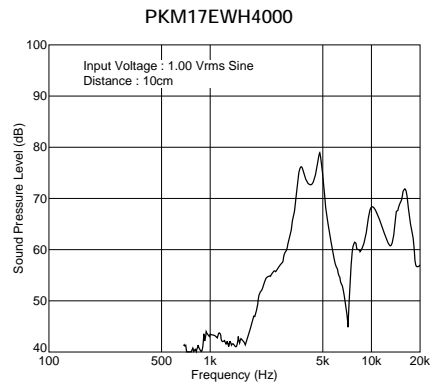
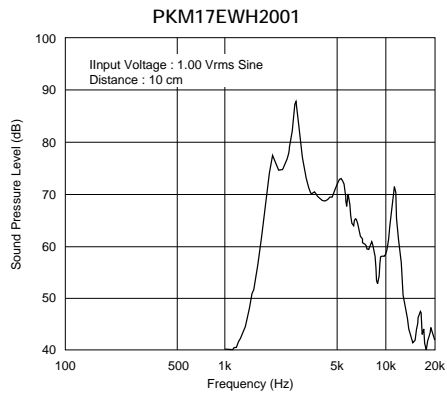

Piezoelectric Sounders (External Drive Lead Wire Type) Circuit/Notice

■ Circuit

The following are examples of externally driven circuits.

- (1) Unstable multi-vibrator using Tr.
- (2) Circuits using inverters or NAND gates.

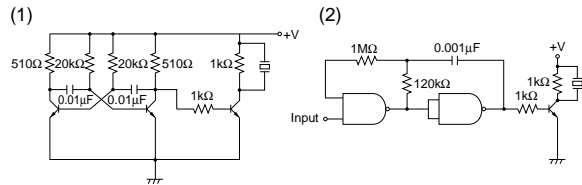

■ Notice (Soldering and Mounting)

Washing of the component is not acceptable, because it is not sealed.

■ Notice (Handling)

1. The component may be damaged if mechanical stress exceeding specifications is applied.
2. Take care to protect operating circuit from surge voltage resulting from excessive force, falling, shock or temperature change.
3. If DC voltage is applied to the component, silver migration may occur. Please pay full attention to avoid subjecting the component to DC voltage for long periods.
4. The resistor should be used as shown in Fig. A. A suitable resistance value should be chosen, preferably 1kΩ to 2kΩ. Instead of this measure, a diode may also be applied as shown in Fig. B.

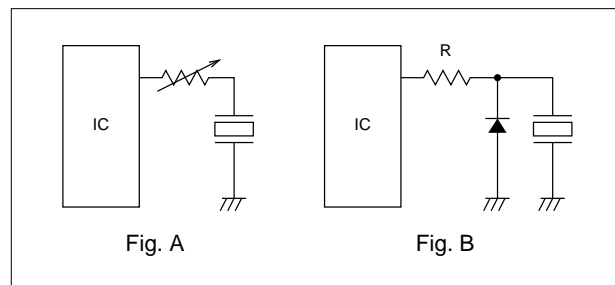

5. Avoid excessive pulling of lead wire because wire may break or soldering point may come off.

Piezoelectric Sound Components



Piezoelectric Sounders External Drive SMD Type

Taking advantage of extensive acoustic and mechanical design technology and high performance ceramics, Murata has developed SMD piezoelectric sounders that suit the thin, high-density design of electronic equipment.

■ Features

1. Small, thin and lightweight
2. High sound pressure level and clear sound
3. Reflowable
4. Tape & Reel supply



PKLCS1212E2000-R1

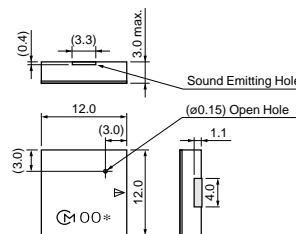

() : Ref. only
(in mm)
Tol. ±0.2



PKLCS1212E4001-R1

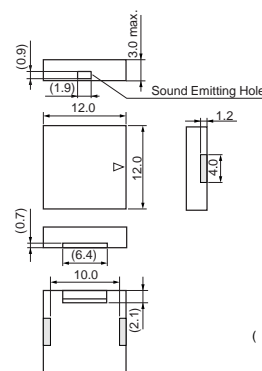

() : Ref. only
(in mm)
Tol. ±0.2

5

Part Number	Sound Pressure Level (dB)	Operating Voltage Range (Vp-p)	Operating Temp. Range (°C)	Storage Temp. Range (°C)	Use
PKLCS1212E2000-R1	70 min.[3Vp-p,2kHz,square wave,10cm]	25 max.	-20 to +70	-30 to +80	For consumer electronics
PKLCS1212E20A0-R1	70 min.[3Vp-p,2kHz,square wave,10cm]	25 max.	-40 to +85	-40 to +85	For automotive electronics
PKLCS1212E4001-R1	75 min.[3Vp-p,4kHz,square wave,10cm]	25 max.	-20 to +70	-30 to +80	For consumer electronics
PKLCS1212E40A1-R1	75 min.[3Vp-p,4kHz,square wave,10cm]	25 max.	-40 to +85	-40 to +85	For automotive electronics

■ Standard Land Pattern Dimensions

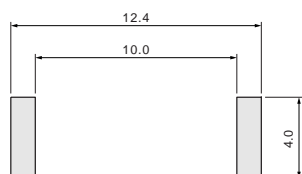

(in mm)

■ Freq. Response (Square Wave 3Vp-p, 10cm)

PKLCS1212E2000-R1

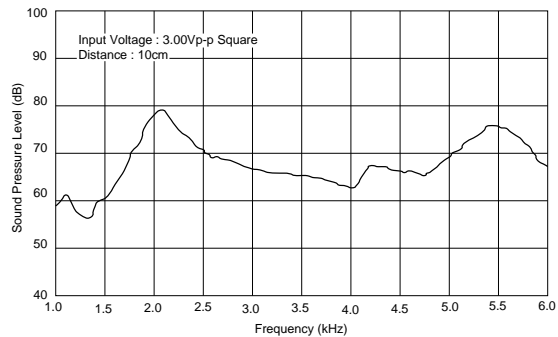

PKLCS1212E4001-R1

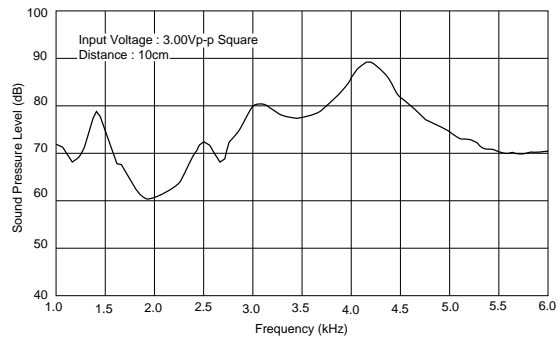

■ Taping Dimension

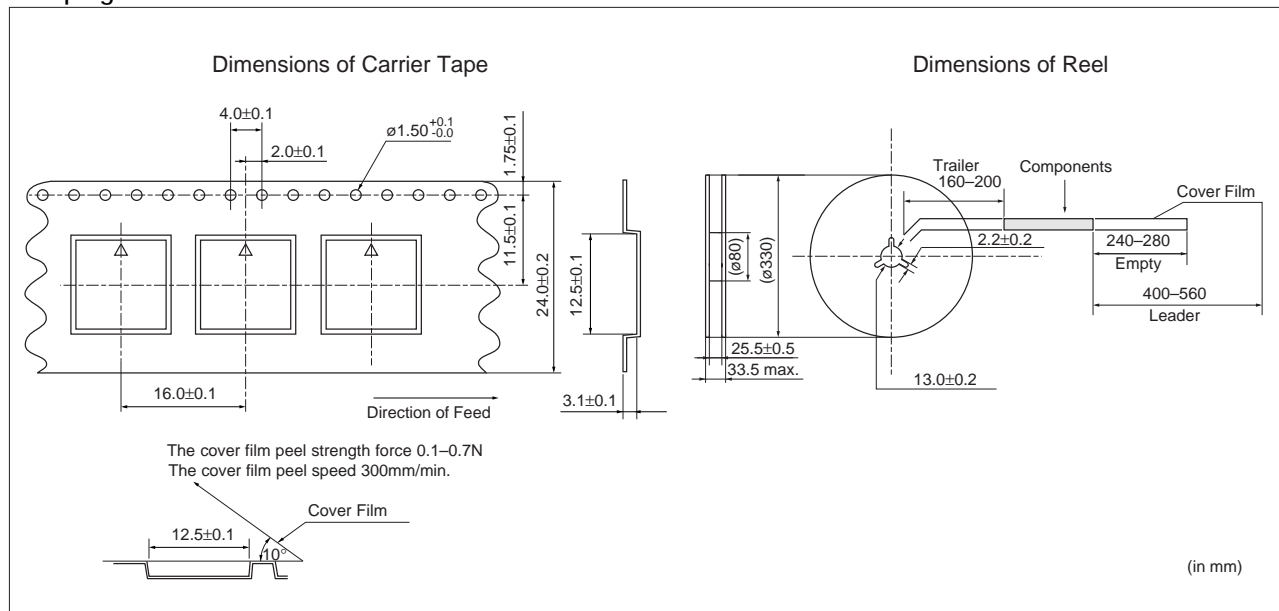

5

Piezoelectric Sounders (External Drive SMD Type) Circuit/Notice

■ Circuit

The following are examples of externally driven circuits.

- (1) Unstable multi-vibrator using Tr.
- (2) Circuits using inverters or NAND gates.

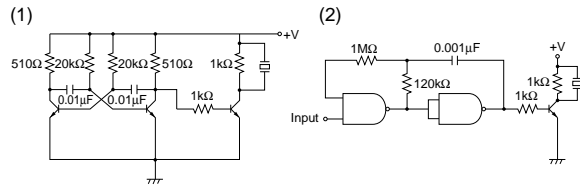

■ Notice (Soldering and Mounting)

Washing of the component is not acceptable, because it is not sealed.

■ Notice (Handling)

1. The component may be damaged if mechanical stress exceeding specifications is applied.
2. Take care to protect operating circuit from surge voltage resulting from excessive force, falling, shock or temperature change.
3. If DC voltage is applied to the component, silver migration may occur. Please pay full attention to avoid subjecting the component to DC voltage for long periods.
4. The resistor should be used as shown in Fig. A. A suitable resistance value should be chosen, preferably 1kΩ to 2kΩ. Instead of this measure, a diode may also be applied as shown in Fig. B.

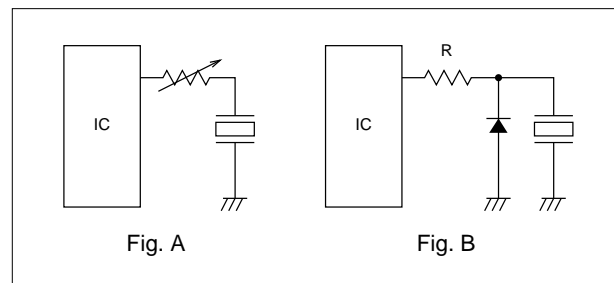

5. Avoid excessive pulling of lead wire because wire may break or soldering point may come off.

Piezoelectric Sound Components



Piezoelectric Ringers (PIEZORINGER®)

As the result of rapid development of ICs in telephones, demand for piezoelectric sounders as telephone ringers has also rapidly increased. To effectively satisfy this rising demand, Murata provides a suitable piezoelectric sounder called "PIEZORINGER" with the following features.

■ Features

1. Extremely clear sound
2. Since it is voltage driven, the power consumption is quite negligible.
3. It can be driven directly from ICs.
4. Thin and lightweight



PKM33EPH1201C

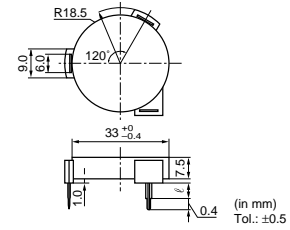

Part Number	ℓ
PKM33EPH1201C	5.0
PKM33EPH1202C	0



PKM34EWH1101C/1201C

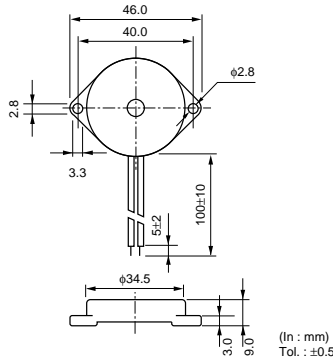

PKM44EWH1001C

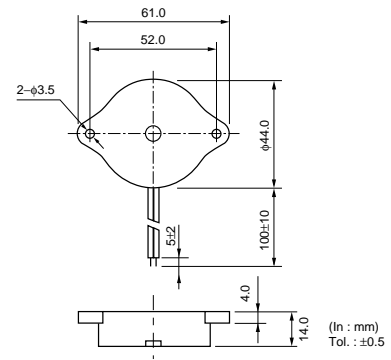

Pin Type

Part Number	Sound Pressure Level (dB)	Sound Pressure Level (Ref. only) (dB)	Operating Voltage Range	Capacitance (nF)	Operating Temp. Range (°C)	Storage Temp. Range (°C)
PKM33EPH1201C	68 min. [30Vp-p, 1.2kHz, square wave, 1m]	65 min. [1Vrms, 1.2kHz, sine wave, 10cm]	40.0 Vp-p max.	40.0 ±30% [120Hz]	-20 to +70	-30 to +80

Lead Wire Type

Part Number	Sound Pressure Level (dB)	Sound Pressure Level (Ref. only) (dB)	Operating Voltage Range	Capacitance (nF)	Operating Temp. Range (°C)	Storage Temp. Range (°C)
PKM34EWH1101C	70 min. [30Vp-p, 1.1kHz, square wave, 1m]	60 min. [1Vrms, 1.1kHz, sine wave, 10cm]	40.0 Vp-p max.	40.0 ±30% [120Hz]	-20 to +70	-30 to +80
PKM34EWH1201C	70 min. [30Vp-p, 1.2kHz, square wave, 1m]	60 min. [1Vrms, 1.2kHz, sine wave, 10cm]	60.0 Vp-p max.	32.0 ±30% [120Hz]	-20 to +70	-30 to +80
PKM44EWH1001C	75 min. [30Vp-p, 1kHz, square wave, 1m]	70 min. [1Vrms, 1kHz, sine wave, 10cm]	30.0 Vp-p max.	68.0 ±30% [120Hz]	-20 to +70	-30 to +80

■ Freq. Response (Square Wave 30Vp-p, 1m)

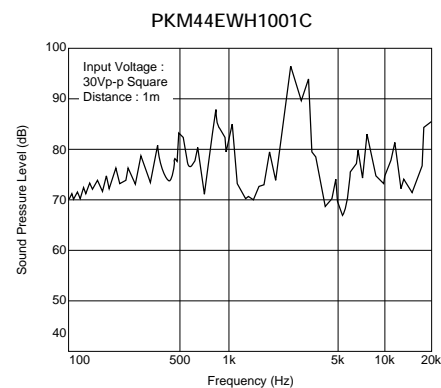
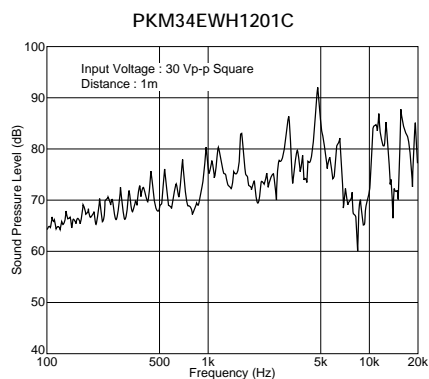
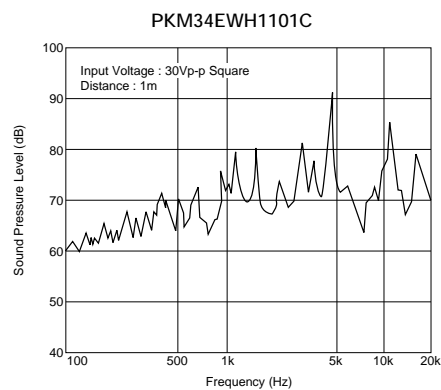
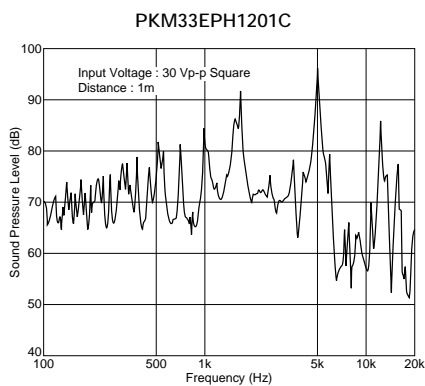

■ Freq. Response (Sine Wave 1Vrms, 10cm)

6

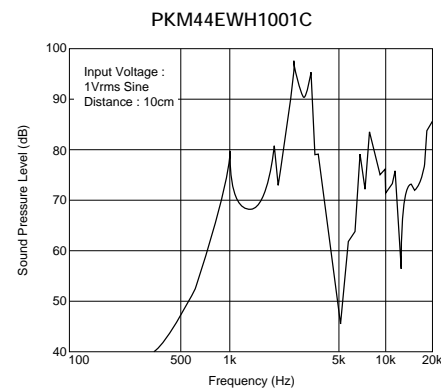
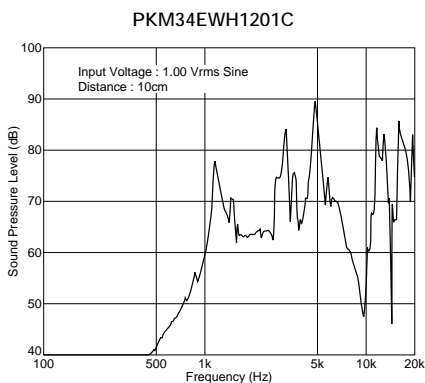
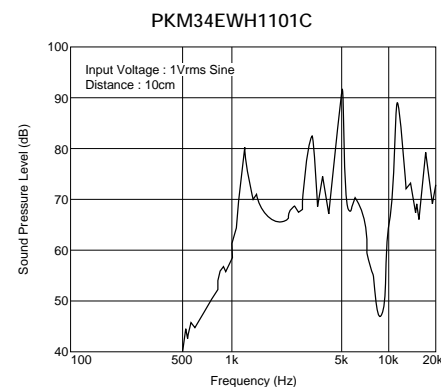
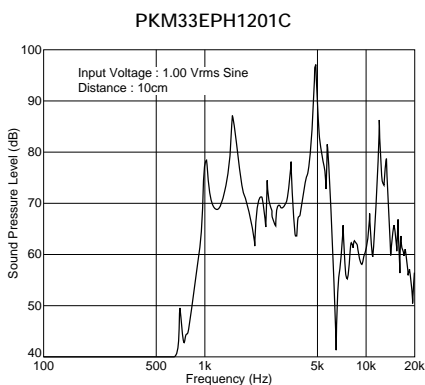

Piezoelectric Ringers (PIEZORINGER®) Notice

■ Notice (Soldering and Mounting)

1. Notice (Soldering and Mounting)

(1) Soldering Iron

- (a) Lead terminals are immersed up to 1.5mm from components body in soldering bath of $+260\pm 5$ degrees C for 10 ± 1.0 seconds, and then components shall be left in natural condition for 4 hours.
- (b) Lead terminal is directly contacted with the tip of soldering iron of $+350\pm 0.5$ seconds, and then components shall be left in natural condition for 4 hours.

(2) Reflow

The component cannot withstand reflow soldering.

2. Washing of the component is not acceptable.

Because it is not sealed.

■ Notice (Handling)

1. The component may be damaged if mechanical stress exceeding specifications is applied.
2. Take care to protect operating circuit from surge voltage resulting from excessive force, falling, shock or temperature change.
3. If DC voltage is applied to the component, silver migration may occur. Please pay full attention to avoid subjecting the component to DC voltage for long periods.
4. The resistor should be used as shown in Fig. A.
A suitable resistance value should be chosen, preferably $1\text{k}\Omega$ to $2\text{k}\Omega$. Instead of this measure, a diode may also be applied as shown in Fig. B.

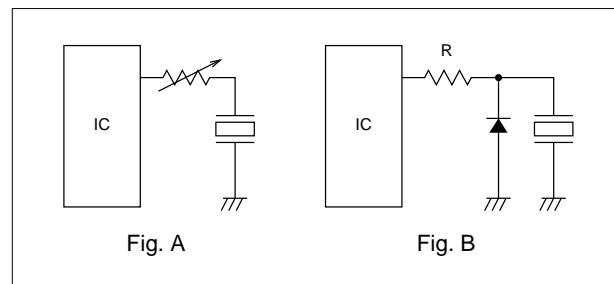

5. Avoid excessive pulling of lead wire because wire may break or soldering point may come off.

Piezoelectric Sound Components



Piezoelectric Sounders Self Drive Pin Type

Piezoelectric sounder self drive type requires only simple circuit and DC power supply. Since this type uses resonant system, it is also available for alarms which need large sound volume.

Applications

1. Gas alarms, burglar alarms, smoke detectors
2. Air conditioners, microwave ovens, washing machines and other home-electronic appliances controlled by microcomputers
3. Toys, game machines

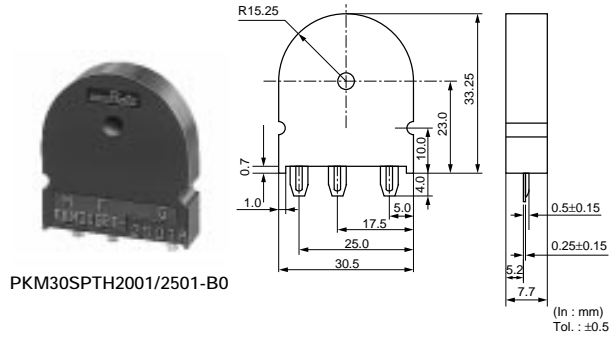
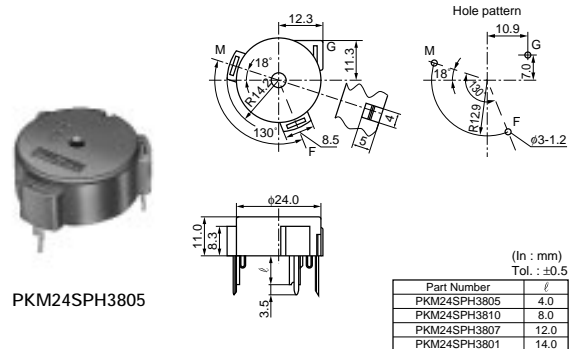

Part Number	Sound Pressure Level (dB)	Oscillating Frequency (kHz)	Current Consumption (mA)	Operating Voltage Range	Operating Temp. Range (°C)	Storage Temp. Range (°C)
PKM24SPH3805	90 min. [12Vdc, 10cm]	3.8 ±0.4kHz [12Vdc]	12 max. [12Vdc]	3.0Vdc to 20.0 Vdc	-20 to +70	-30 to +80
PKM30SPH2001-B0	75 min. [12Vdc, 10cm]	2.0 ±0.3kHz [12Vdc]	20 max. [12Vdc]	3.0Vdc to 20.0 Vdc	-20 to +70	-30 to +80
PKM30SPH2501-B0	75 min. [12Vdc, 10cm]	2.5 ±0.3kHz [12Vdc]	20 max. [12Vdc]	3.0Vdc to 20.0 Vdc	-20 to +70	-30 to +80

7

Standard Circuit Examples

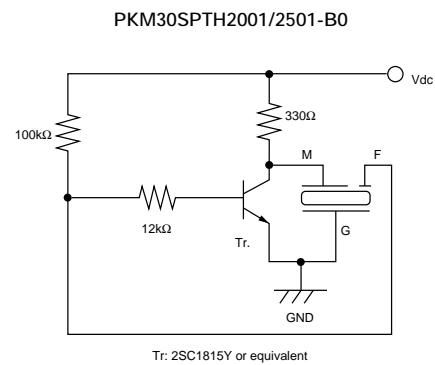
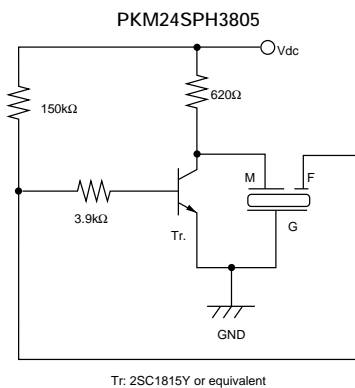

Piezoelectric Sounders (Self Drive) Notice

■ Notice (Soldering and Mounting)

1. Notice (Soldering and Mounting)

(1) Soldering Iron

- (a) Lead terminals are immersed up to 1.5mm from components body in soldering bath of +260+/-5 degrees C for 10+/-1.0 seconds, and then components shall be left in natural condition for 4 hours.
- (b) Lead terminal is directly contacted with the tip of soldering iron of +350+/-0.5 seconds, and then components shall be left in natural condition for 4 hours.

(2) Reflow

The component cannot withstand reflow soldering.

2. Washing of the component is not acceptable.

Because it is not sealed.

3. Please do not cover the hole with tape or other obstacle as this will produce irregular oscillation.
4. There should not be any obstacle within 15mm from top of the component as this will produce irregular oscillation.

■ Notice (Handling)

1. The component may be damaged if mechanical stress exceeding specifications is applied.
2. Take care to protect operating circuit from surge voltage resulting from excessive force, falling, shock or temperature change.
3. If DC voltage is applied to the component, silver migration may occur. Please pay full attention to avoid subjecting the component to DC voltage for long periods.
4. The standard self-driven circuits utilizes transistor switching. Since the circuit constants for hfe of the transistor are optimally chosen to maintain stable oscillation, please design a circuit following the standard.

Piezoelectric Sound Components



Piezoelectric Buzzers

This is a unified piezoelectric sounder which has a piezoelectric diaphragm of 3 terminals connected to a self drive circuit, and it easily generates sound with only a DC power supply (DC3.0-20V). Using suitably designed resonant system, this type can be used where large sound volumes are needed.

■ Applications

1. Gas alarms, burglar alarms
2. Air conditioners, microwave ovens and various types of microcomputer controlled home-electronic appliances
3. Toys, games, and other simple electronic devices such as teaching aids



PKB24SPCH3601-B0

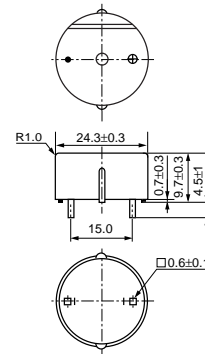

PKB24SWH3301

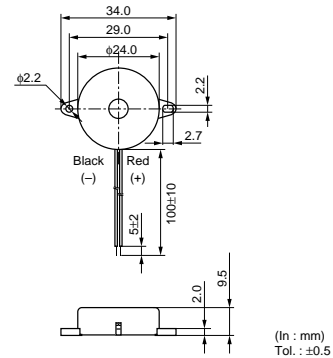

Pin Type

Part Number	Sound Pressure Level (dB)	Oscillating Frequency (kHz)	Current Consumption (mA)	Operating Voltage Range	Operating Temp. Range (°C)	Storage Temp. Range (°C)
PKB24SPCH3601-B0	90 min. [12Vdc, 10cm]	3.6 ±0.5kHz [12Vdc]	16 max. [12Vdc]	3.0Vdc to 15.0 Vdc	-20 to +70	-30 to +80

Lead Wire Type

Part Number	Sound Pressure Level (dB)	Oscillating Frequency (kHz)	Current Consumption (mA)	Operating Voltage Range	Operating Temp. Range (°C)	Storage Temp. Range (°C)
PKB24SWH3301	80 min. [12Vdc, 10cm]	3.3 ±0.5kHz [12Vdc]	12 max. [12Vdc]	3.0Vdc to 20.0 Vdc	-20 to +70	-30 to +80

■ Voltage-Sound Pressure Level/Voltage-Consumption Current

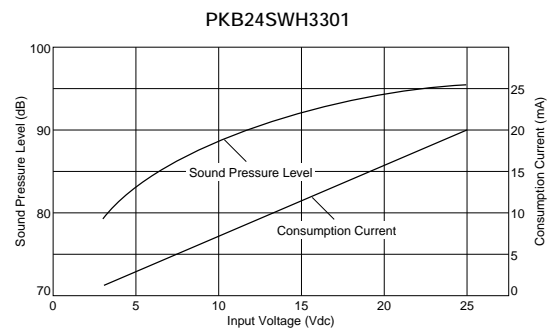
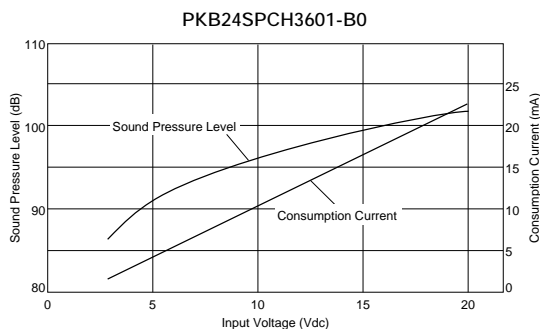

Piezoelectric Buzzers Notice

■ Notice (Soldering and Mounting)

1. Notice (Soldering and Mounting)

(1) Soldering Iron

- (a) Lead terminals are immersed up to 1.5mm from components body in soldering bath of $+260\pm 5$ degrees C for 10 ± 1.0 seconds, and then components shall be left in natural condition for 4 hours.
- (b) Lead terminal is directly contacted with the tip of soldering iron of $+350\pm 0.5$ seconds, and then components shall be left in natural condition for 4 hours.

(2) Reflow

The component cannot withstand reflow soldering.

■ Notice (Handling)

1. The component may be damaged if mechanical stress over this specification is applied.
2. Resistors should not be connected in series to the power supply as this will produce irregular oscillation. When resistor is necessary to control sound volume, use capacitor ($1\mu\text{F}$) parallel with the buzzer together.
3. Please pay enough attention not to pull lead wire too much because wire may be broken or soldering point may come off.

2. Washing of the component is not acceptable. Because it is not sealed.
3. Please do not cover the hole with tape or other obstacle as this will produce irregular oscillation.
4. There should not be any obstacle within 15mm from top of the component as this will produce irregular oscillation.

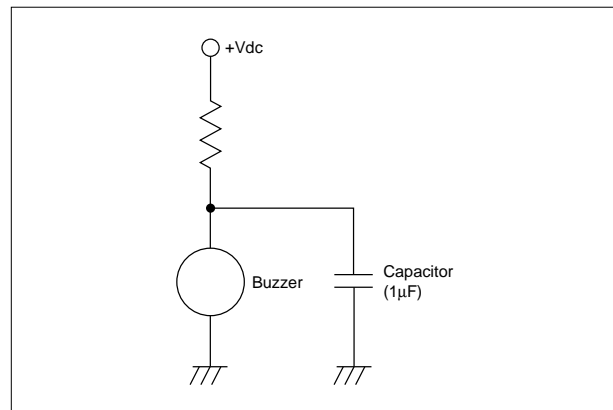

Piezoelectric Sound Components Notice

■ Notice (Storage and Operating Condition)

1. Product Storage Condition

Please store the products in room where the temperature/humidity is stable. And avoid such places where there are large temperature changes. Please store the products under the following conditions:

Temperature: -10 to + 40 degree C

Humidity: 15 to 85% R.H.

2. Expiration Date on Storage

Expire date (Shelf life) of the products is six months after delivery under the conditions of a sealed and an unopened package. Please use the products within six months after delivery. If you store the products for a long time (more than six months), use carefully because the products may be degraded in solderability due to storage under poor conditions.

Please confirm solderability and characteristics for the products regularly.

3. Notice on Product Storage

- (1) Please do not store the products in a chemical atmosphere (Acids, Alkali, Bases, Organic gas, Sulfides and so on), because the characteristics may be reduced in quality, may be degraded in solderability due to the storage in a chemical atmosphere.

- (2) Please do not put the products directly on the floor without anything under them to avoid damp places and/or dusty places.

- (3) Please do not store the products in the places such as: in a damp heated place, in any place exposed to direct sunlight or excessive vibration.

- (4) Please use the products immediately after the package is opened, because the characteristics may be reduced in quality, and/or be degraded in the solderability due to storage under the poor condition.

- (5) Please do not drop the products to avoid cracking of ceramic element.

4. Others

Please be sure to consult with our sales representative or engineer whenever the products are to be used in conditions not listed above.

Package

■ Minimum Quantity (pcs.)

Product Names	Part Number	Minimum Quantity			
		Ø330mm Reel	Bulk (Box)	Ammo Pack	Magazine
● Piezoelectric Diaphragms*					
External Drive Types	7BB-12-9		5120		
	7BB-15-6		8000		
	7BB-20-3		3000		
	7BB-20-6		1800		
	7BB-20-6L0		600		
	7BB-27-4		1500		
	7BB-27-4L0		600		
	7BB-35-3		800		
	7BB-35-3L0		400		
	7BB-41-2		400		
	7BB-41-2L0		250		
	7NB-31R2-1		3000		
	Self Drive Types	7BB-20-6C		1800	
7BB-20-6CL0			600		
7BB-27-4C			1500		
7BB-27-4CL0			600		
7BB-35-3C			800		
7BB-35-3CL0			400		
7BB-41-2C			600		
7BB-41-2CL0			250		
7SB-34R7-3C			800		
● Piezoelectric Sounders*					
External Drive Types	PKLCS1212E2000-R1	1000			
	PKLCS1212E20A0-R1	1000			
	PKLCS1212E4001-R1	1000			
	PKLCS1212E40A1-R1	1000			
	PKM13EPYH4000-A0			500	
	PKM13EPYH4002-B0		330		
	PKM17EPP-2002-B0		200		
	PKM17EPPH4001-B0		200		
	PKM17EPPH4002-B0		200		
	PKM17EWH2001		250		
	PKM17EWH4000		500		
	PKM22EPH2001		360		
	PKM22EPH2002		270		
	PKM22EPH2003		270		
	PKM22EPPH2001-B0		750		
	PKM22EPPH2002-B0		750		
	PKM22EPPH4001-B0		900		
	PKM22EPPH4002-B0		900		
	PKM22EPPH4005-B0		750		
	PKM22EPPH4007-B0		750		
	PKM22EPPH4012-B0		750		
	PKM22EPTH2001-B0		300		75 ¹⁾

1) The last two digits are changed to M0.

Continued on the following page. 

"Minimum Quantity" means the number of units of each delivery or order. The quantity should be an integral multiple of the "Minimum Quantity". (As for products series with ★mark, bulk (bag) quantities shown here differ from actual delivery quantities in a package.) Please contact nearest sales office for details and for any other products not listed above.

Package

Continued from the preceding page.

Product Names	Part Number	Minimum Quantity			
		Ø330mm Reel	Bulk (Box)	Ammo Pack	Magazine
Self Drive Types	PKM24SPH3801		270		
	PKM24SPH3805		360		
	PKM24SPH3807		270		
	PKM24SPH3810		270		
	PKM30SPTH2001-B0		70		
	PKM30SPTH2501-B0		70		
● Piezoelectric Buzzers*	PKB24SPCH3601-B0		650		
	PKB24SWH3301		200		
● Piezoelectric Ringers (PIEZORINGER®)*	PKM33EPH1201C		300		
	PKM33EPH1202C		60		
	PKM34EWH1101C		25		
	PKM34EWH1201C		25		
	PKM44EWH1001C		25		

△Note:

1. Export Control

<For customers outside Japan>

No Murata products should be used or sold, through any channels, for use in the design, development, production, utilization, maintenance or operation of, or otherwise contribution to (1) any weapons (Weapons of Mass Destruction [nuclear, chemical or biological weapons or missiles] or conventional weapons) or (2) goods or systems specially designed or intended for military end-use or utilization by military end-users.

<For customers in Japan>

For products which are controlled items subject to the "Foreign Exchange and Foreign Trade Law" of Japan, the export license specified by the law is required for export.

2. Please contact our sales representatives or product engineers before using the products in this catalog for the applications listed below, which require especially high reliability for the prevention of defects which might directly damage a third party's life, body or property, or when one of our products is intended for use in applications other than those specified in this catalog.

- | | |
|-----------------------------|--|
| ① Aircraft equipment | ② Aerospace equipment |
| ③ Undersea equipment | ④ Power plant equipment |
| ⑤ Medical equipment | ⑥ Transportation equipment (vehicles, trains, ships, etc.) |
| ⑦ Traffic signal equipment | ⑧ Disaster prevention / crime prevention equipment |
| ⑨ Data-processing equipment | ⑩ Application of similar complexity and/or reliability requirements to the applications listed above |

3. Product specifications in this catalog are as of November 2009. They are subject to change or our products in it may be discontinued without advance notice. Please check with our sales representatives or product engineers before ordering. If there are any questions, please contact our sales representatives or product engineers.

4. Please read rating and △ CAUTION (for storage, operating, rating, soldering, mounting and handling) in this catalog to prevent smoking and/or burning, etc.

5. This catalog has only typical specifications because there is no space for detailed specifications. Therefore, please approve our product specifications or transact the approval sheet for product specifications before ordering.

6. Please note that unless otherwise specified, we shall assume no responsibility whatsoever for any conflict or dispute that may occur in connection with the effect of our and/or a third party's intellectual property rights and other related rights in consideration of your use of our products and/or information described or contained in our catalogs. In this connection, no representation shall be made to the effect that any third parties are authorized to use the rights mentioned above under licenses without our consent.

7. No ozone depleting substances (ODS) under the Montreal Protocol are used in our manufacturing process.

***murata* Murata Manufacturing Co., Ltd.**

<http://www.murata.com/>

Head Office

1-10-1, Higashi Kotari, Nagaokakyo-shi, Kyoto 617-8555, Japan
Phone: 81-75-951-9111

International Division

3-29-12, Shibuya, Shibuya-ku, Tokyo 150-0002, Japan
Phone: 81-3-5469-6123 Fax: 81-3-5469-6155 E-mail: intl@murata.co.jp