

TOSHIBA MOS TYPE INTEGRATED CIRCUIT SILICON MONOLITHIC

TA4006F

TV TUNER VHF RF AMPLIFIER APPLICATIONS.
TV TUNER UHF RF AMPLIFIER APPLICATIONS.
FM TUNER RF AMPLIFIER APPLICATIONS.

FEATURES

- On account of this Device Built-in Bias Circuit, Cut down number of articles.
- Low Noise Figure : NF = 2.0dB (Typ.)
- Operating Voltage : $V_{DD} = 6 \sim 11V$

PIN ASSIGNMENT (TOP VIEW)

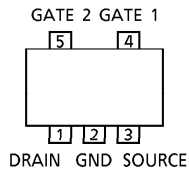

MARKING

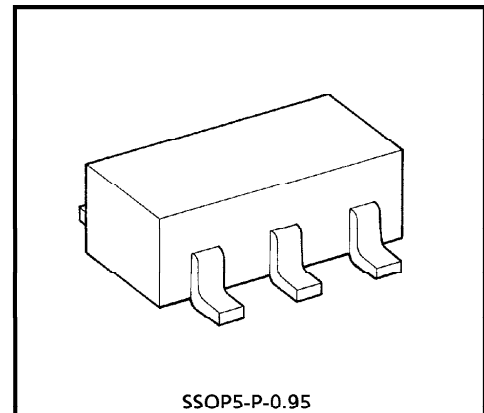
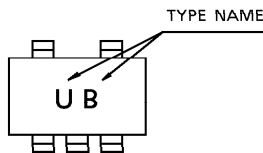

SSOP5-P-0.95
 Weight : 0.014g (Typ.)

MAXIMUM RATINGS (Ta = 25°C)

CHARACTERISTIC	SYMBOL	RATING	UNIT
Supply Voltage	V_{DD}	11	V
Gate 2-Source Voltage	V_{G2S}	± 8	V
Supply Current	I_{DD}	30	mA
Power Dissipation	P_D^*	250	mW
Operating Temperature	T_{opr}	- 40~85	°C
Storage Temperature	T_{stg}	- 55~125	°C

* When mounted on the glass epoxy board of 2.5cm² × 1.6t

961001EBA2

- TOSHIBA is continually working to improve the quality and the reliability of its products. Nevertheless, semiconductor devices in general can malfunction or fail due to their inherent electrical sensitivity and vulnerability to physical stress. It is the responsibility of the buyer, when utilizing TOSHIBA products, to observe standards of safety, and to avoid situations in which a malfunction or failure of a TOSHIBA product could cause loss of human life, bodily injury or damage to property. In developing your designs, please ensure that TOSHIBA products are used within specified operating ranges as set forth in the most recent products specifications. Also, please keep in mind the precautions and conditions set forth in the TOSHIBA Semiconductor Reliability Handbook.
- The products described in this document are subject to foreign exchange and foreign trade control laws.
- The information contained herein is presented only as a guide for the applications of our products. No responsibility is assumed by TOSHIBA CORPORATION for any infringements of intellectual property or other rights of the third parties which may result from its use. No license is granted by implication or otherwise under any intellectual property or other rights of TOSHIBA CORPORATION or others.
- The information contained herein is subject to change without notice.

ELECTRICAL CHARACTERISTICS (Ta = 25°C)

CHARACTERISTIC	SYMBOL	TEST CIR-CUIT	TEST CONDITION	MIN.	TYP.	MAX.	UNIT
Gate 2 Leakage Current	I_{G2SS}	—	$V_{DS} = 0, V_{G1S} = 0, V_{G2S} = \pm 6V$	—	—	± 50	nA
Gate 2-Source Cut-off Voltage	$V_{G2S(OFF)}$	—	$V_{DD} = 5V, I_{DD} = 150\mu A$	0.5	1.0	1.5	V
Supply Current	I_{DD}	—	$V_{DD} = 9V, V_{G2} = 7V$	6	—	14	mA
Input Capacitance	C_{iss}	—	$V_{DD} = 9V, V_{G2} = 7V$	1.5	2.2	2.9	pF
Output Capacitance	C_{oss}	—	$f = 1MHz$	0.8	1.4	2.0	pF
Power Gain	G_{ps}	1	$V_{DD} = 9V, V_{G2} = 7V$	19	24.0	—	dB
Noise Figure	NF	1	$f = 500MHz$	—	2.0	2.9	dB

I_{DD} Classifications : Y : 6~10mA, GR : 8~12mA, BL : 10~14mA.

EQUIVALENT CIRCUIT

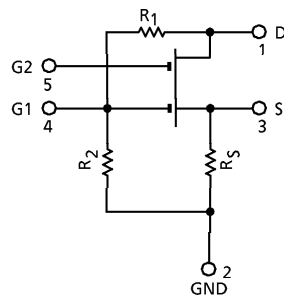

TEST CIRCUIT 1

500MHz, G_{ps} , NF

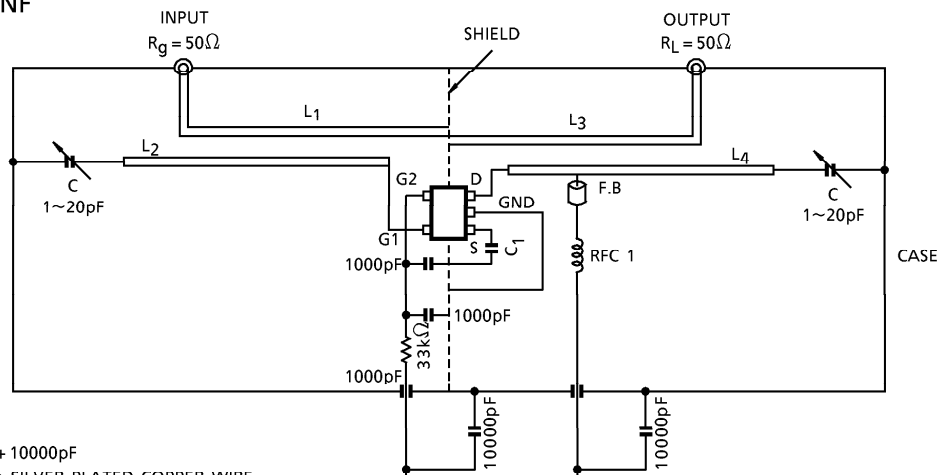

- C_1 : 1000pF + 10000pF
- L_1, L_4 : $\phi 0.8mm$ SILVER PLATED COPPER WIRE
- C : AIR TRIMMER TTA25A200A (MURATA MFG. Co., Ltd.)
- RFC 1 : $\phi 0.35mm$ COPPER WIRE 3mm ID, 10T

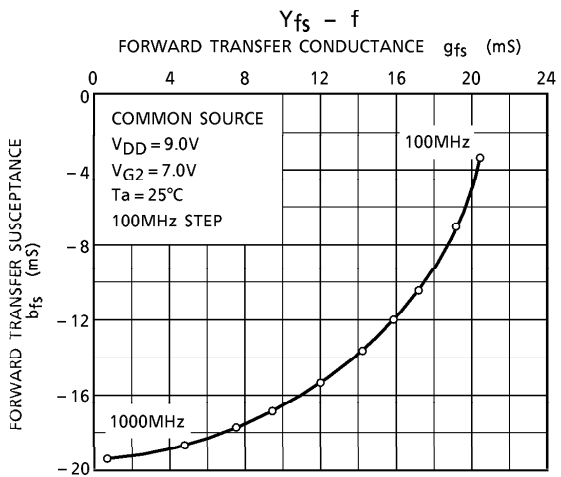
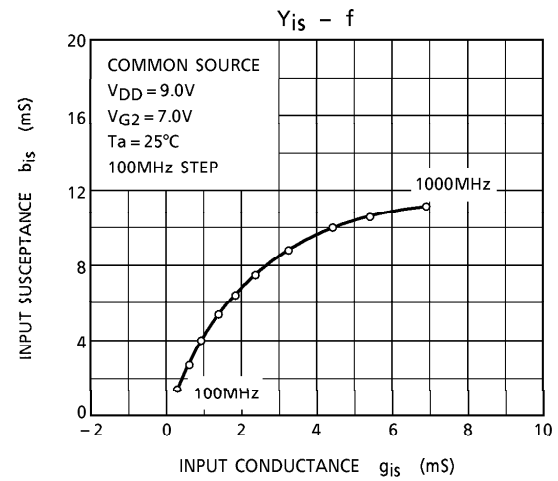
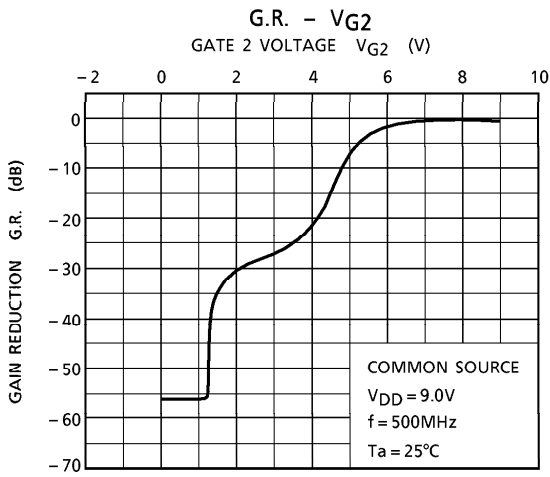
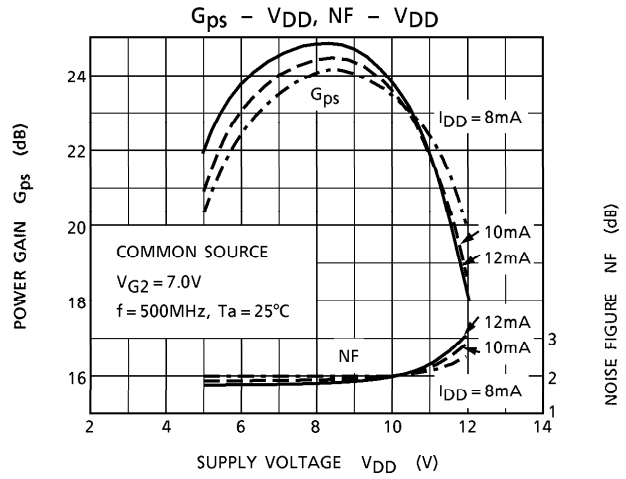
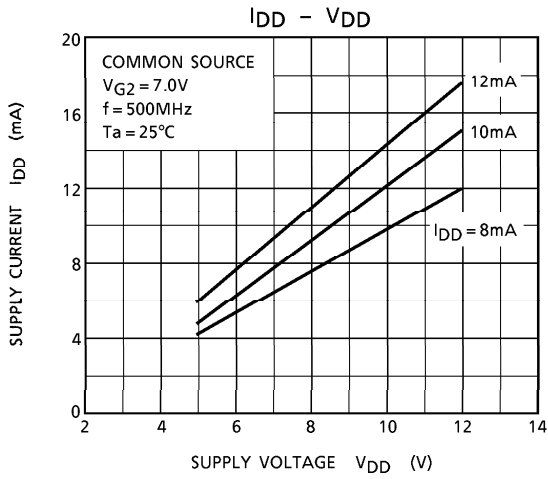

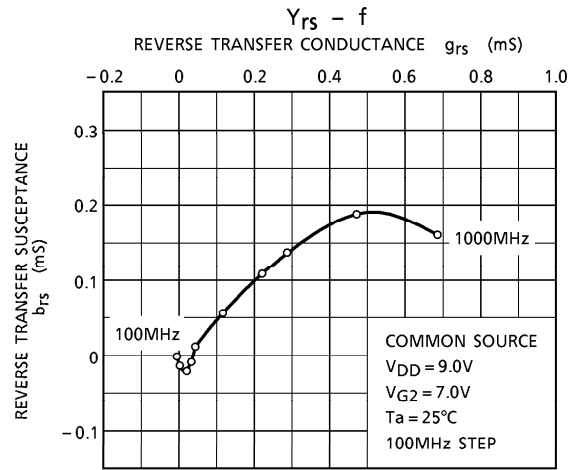
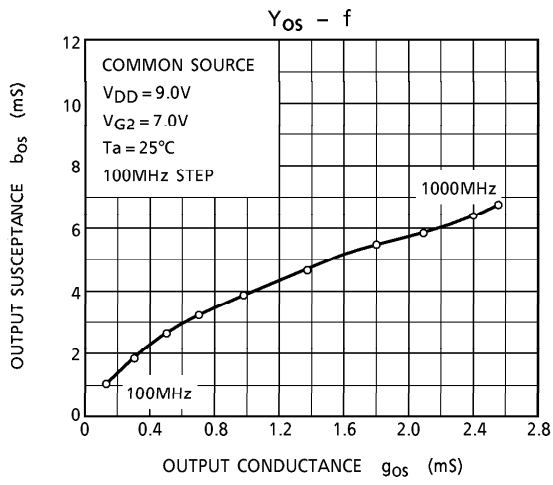

OUTLINE DRAWING
SSOP5-P-0.95

Unit : mm

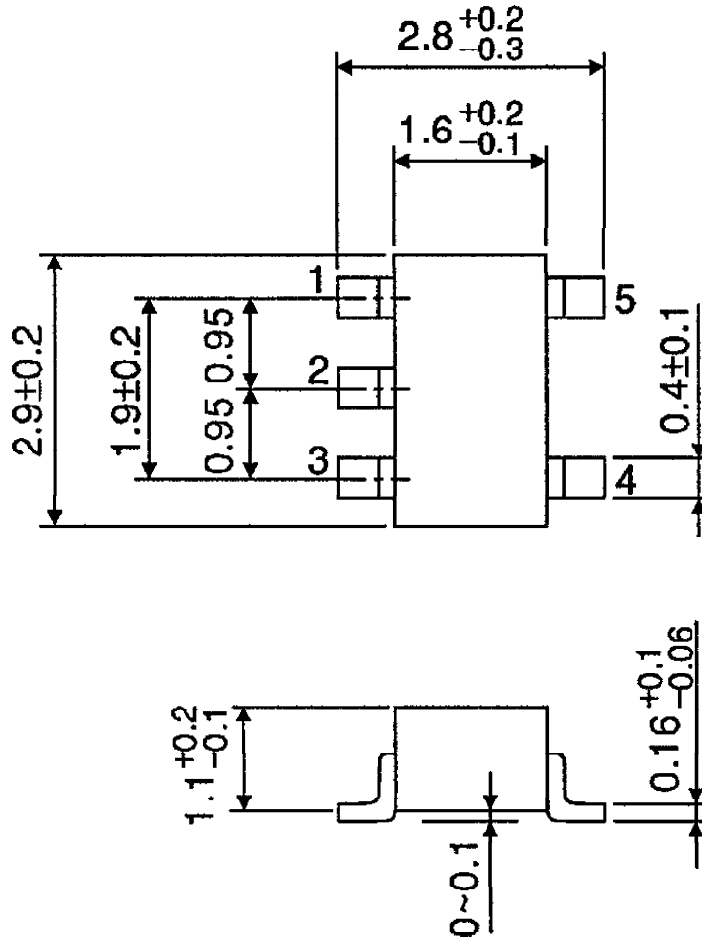

Weight : 0.014g (Typ.)