

TA4009F

1.9GHz BAND PRE AMPLIFIER APPLICATION

FEATURES

- Low current : $I_{CC} = 12\text{mA}$ (Typ.)
- High gain : $G_p = 12\text{dB}$ (Typ.)
- Recommended operating voltage : $V_{CC} = 2.7\sim 3.3\text{V}$

PIN ASSIGNMENT (TOP VIEW)

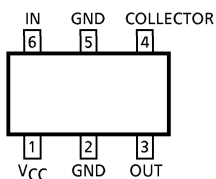

MARKING

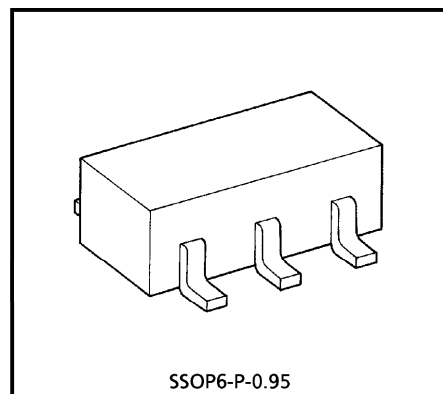
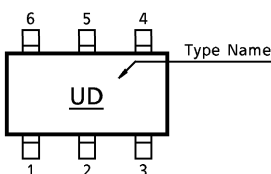

Weight : 0.014g (Typ.)

MAXIMUM RATINGS (Ta = 25°C)

CHARACTERISTIC	SYMBOL	RATING	UNIT
Supply Voltage	V_{CC}	5	V
Total Power Dissipation	P_D (*)	300	mW
Operating Temperature	T_{opr}	-40~85	°C
Storage Temperature Range	T_{stg}	-55~125	°C

(*) When mounted on the glass epoxy board of 2.5cm² × 1.6t.

ELECTRICAL CHARACTERISTICS (V_{CC} = 3V, Ta = 25°C, Z_g = Z_l = 50Ω)

CHARACTERISTIC	SYMBOL	TEST CIR-CUIT	TEST CONDITION	MIN.	TYP.	MAX.	UNIT
Circuit Current	I_{CC}	—	Non Carrier	—	12	16	mA
Frequency Range	f_{range}	—	—	1895	—	1918	MHz
Power Gain	G_p	1	f = 1895~1918MHz	10	12	—	dB
Noise Figure	NF	1		—	6	—	dB
Isolation	ISL	1		15	20	—	dB
Input VSWR	$VSWR_{in}$	1		—	1.2	2.0	—
Output VSWR	$VSWR_{out}$	1		—	2.5	—	—
Output Power At 1dB Gain Compression	P_{O1dB}	1		—	-8	—	dBmW

961001EBA2

● TOSHIBA is continually working to improve the quality and the reliability of its products. Nevertheless, semiconductor devices in general can malfunction or fail due to their inherent electrical sensitivity and vulnerability to physical stress. It is the responsibility of the buyer, when utilizing TOSHIBA products, to observe standards of safety, and to avoid situations in which a malfunction or failure of a TOSHIBA product could cause loss of human life, bodily injury or damage to property. In developing your designs, please ensure that TOSHIBA products are used within specified operating ranges as set forth in the most recent products specifications. Also, please keep in mind the precautions and conditions set forth in the TOSHIBA Semiconductor Reliability Handbook.

TEST CIRCUIT 1.

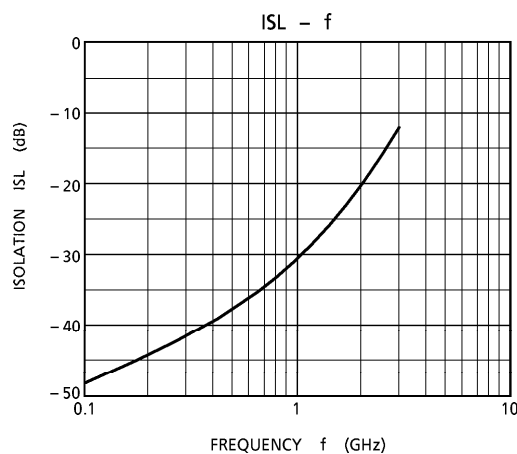
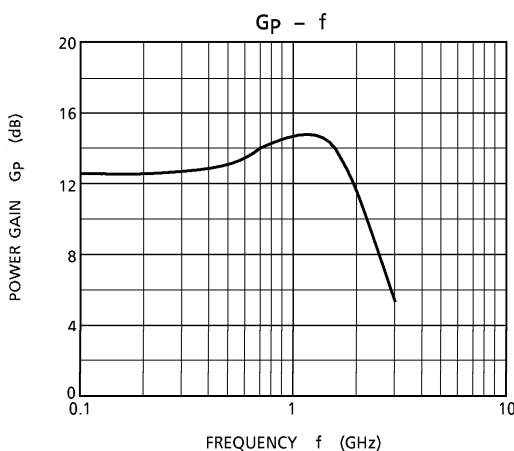
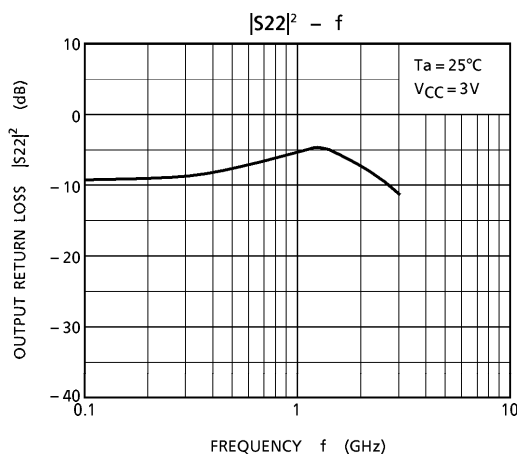
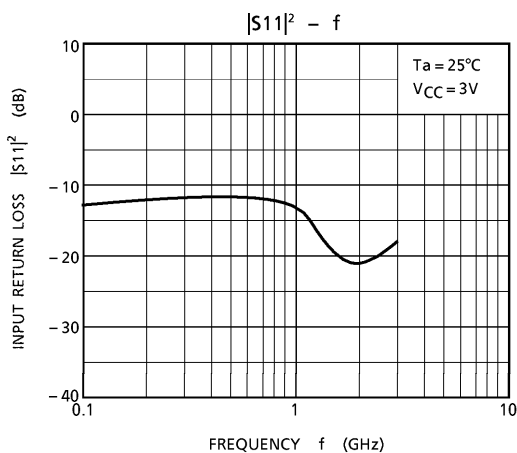
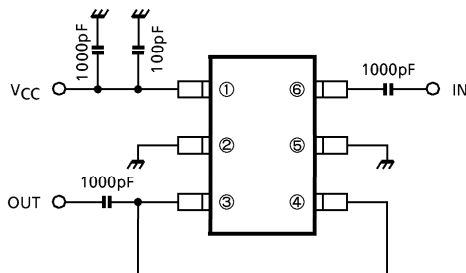

961001EBA2

- The products described in this document are subject to foreign exchange and foreign trade control laws.
- The information contained herein is presented only as a guide for the applications of our products. No responsibility is assumed by TOSHIBA CORPORATION for any infringements of intellectual property or other rights of the third parties which may result from its use. No license is granted by implication or otherwise under any intellectual property or other rights of TOSHIBA CORPORATION or others.
- The information contained herein is subject to change without notice.

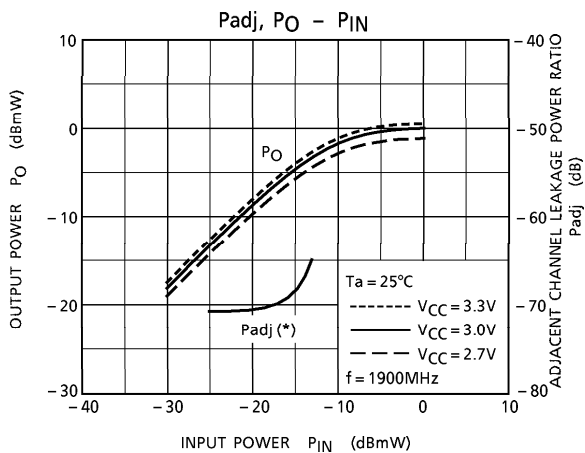
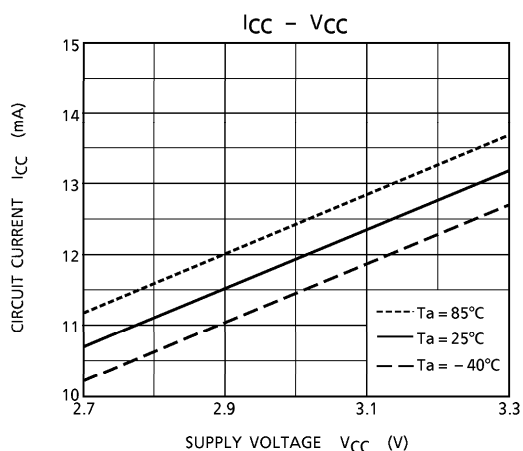
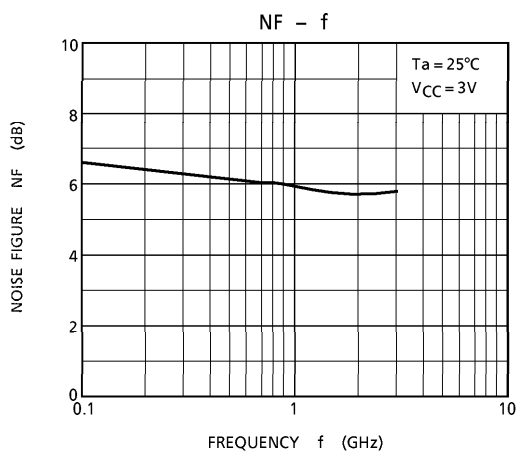

(*) Input signal is modulated to $\pi/4$ QPSK ($\alpha = 0.5$). Bit rate is 384kbps. $\Delta f = 600$ kHz.

OUTLINE DRAWING
SSOP6-P-0.95

Unit : mm

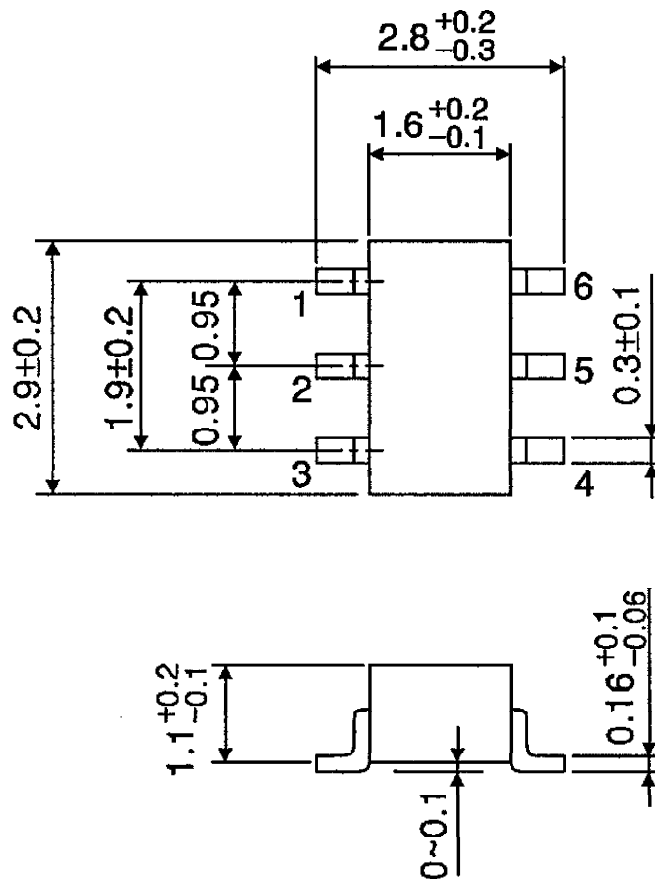

Weight : 0.014g (Typ.)