

**SPS**

The SPS product family is specially designed for an off-line SMPS with minimal external components. The SPS consist of high voltage power SenseFET and current mode PWM IC. Included PWM controller features integrated fixed oscillator, under voltage lock out, leading edge blanking, optimized gate turn-on/turn-off driver, thermal shut down protection, over voltage protection, and temperature compensated precision current sources for loop compensation and fault protection circuitry. Compared to discrete MOSFET and controller or RCC switching converter solution, a SPS can reduce total component count, design size, weight and at the same time increase efficiency, productivity, and system reliability. It has a basic platform well suited for cost effective design in either a flyback converter or a forward converter.

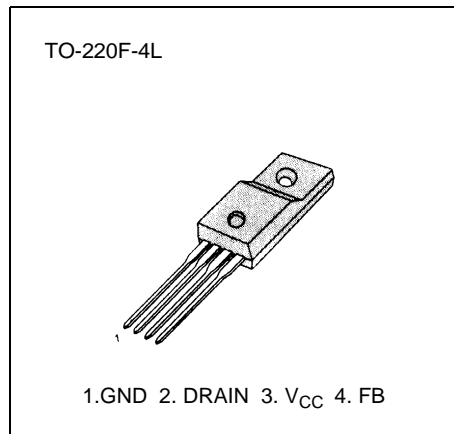

**FEATURES**

- Precision fixed operating frequency (70kHz)
- Pulse by pulse over current limiting
- Over Current Protection
- Over Voltage Protection (Min. 23V)
- Internal thermal shutdown function
- Under voltage lockout
- Internal high voltage sense FET
- Auto restart

**ORDERING INFORMATION**

Device	Package	Operating Temperature
KA1M0280R	TO-220F-4L	-25°C to +85°C

**BLOCK DIAGRAM**

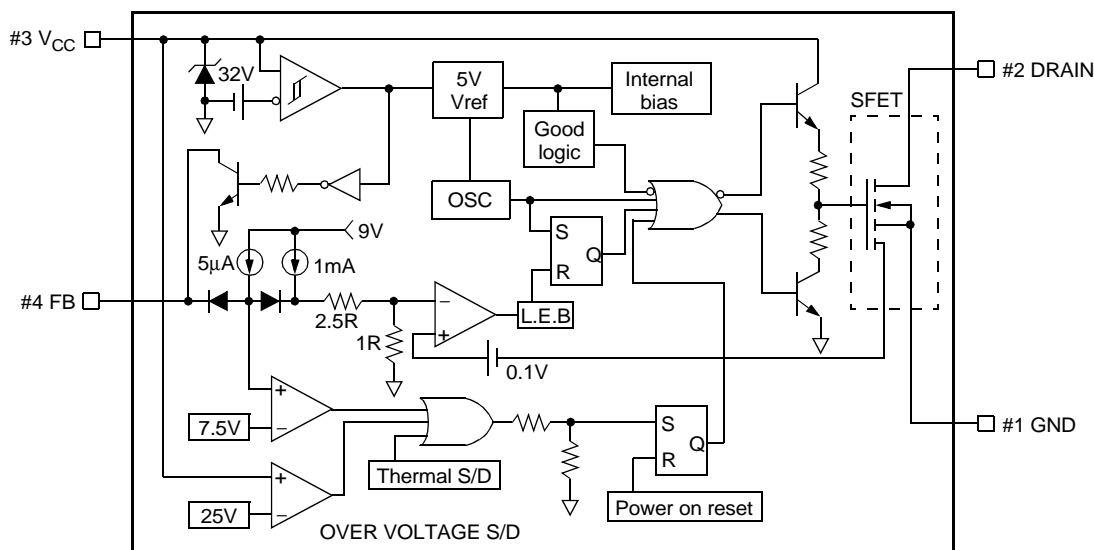

## ABSOLUTE MAXIMUM RATINGS

Characteristic	Symbol	Value	Unit
Drain-source (GND) voltage <sup>(1)</sup>	$V_{DSS}$	800	V
Drain-Gate voltage ( $R_{GS}=1M\Omega$ )	$V_{DGR}$	800	V
Gate-source (GND) voltage	$V_{GS}$	$\pm 30$	V
Drain current pulsed <sup>(2)</sup>	$I_{DM}$	8.0	$A_{DC}$
Single pulsed avalanche energy <sup>(3)</sup>	$E_{AS}$	90	mJ
Avalanche current <sup>(4)</sup>	$I_{AS}$	–	A
Continuous drain current ( $T_C=25^\circ C$ )	$I_D$	2.0	$A_{DC}$
Continuous drain current ( $T_C=100^\circ C$ )	$I_D$	1.3	$A_{DC}$
Supply voltage	$V_{CC}$	30	V
Analog input voltage range	$V_{FB}$	$-0.3$ to $V_{SD}$	V
Total power dissipation	$P_D$ (watt H/S)	35	W
	Derating	0.28	$W/^\circ C$
Operating temperature	$T_{OPR}$	$-25$ to $+85$	$^\circ C$
Storage temperature	$T_{STG}$	$-55$ to $+150$	$^\circ C$

## NOTES:

- $T_j=25^\circ C$  to  $150^\circ C$
- Repetitive rating: Pulse width limited by maximum junction temperature
- $L=51mH$ ,  $V_{DD}=50V$ ,  $R_G=25\Omega$ , starting  $T_j=25^\circ C$

**ELECTRICAL CHARACTERISTICS (SFET part)**

(Ta=25°C unless otherwise specified)

Characteristic	Symbol	Test condition	Min.	Typ.	Max.	Unit
Drain-source breakdown voltage	$BV_{DSS}$	$V_{GS}=0V, I_D=50\mu A$	8000	–	–	V
Zero gate voltage drain current	$I_{DSS}$	$V_{DS}=\text{Max.}, \text{Rating}, V_{GS}=0V$	–	–	50	$\mu A$
		$V_{DS}=0.8\text{Max.}, \text{Rating}, V_{GS}=0V, T_C=125^\circ C$	–	–	200	$\mu A$
Static drain-source on resistance <sup>(note)</sup>	$R_{DS(ON)}$	$V_{GS}=10V, I_D=1.0A$	–	5.6	7.0	$\Omega$
Forward transconductance <sup>(note)</sup>	gfs	$V_{DS}=50V, I_D=1.0A$	1.5	2.5	–	mho
Input capacitance	$C_{iss}$	$V_{GS}=0V, V_{DS}=25V, f=1\text{MHz}$	–	250	–	$\mu F$
Output capacitance	$C_{oss}$		–	52	–	
Reverse transfer capacitance	$C_{rss}$		–	25	–	
Turn on delay time	td(on)	$V_{DD}=0.5BV_{DSS}, I_D=2.0A$ (MOSFET switching time are essentially independent of operating temperature)	–	21	–	nS
Rise time	tr		–	28	–	
Turn off delay time	td(off)		–	77	–	
Fall time	tf		–	24	–	
Total gate charge (gate-source+gate-drain)	Qg	$V_{GS}=10V, I_D=2.0A, V_{DS}=0.5BV_{DSS}$ (MOSFET switching time are essentially independent of operating temperature)	–	–	60	nC
Gate-source charge	Qgs		–	15	–	
Gate-drain (Miller) charge	Qgd		–	20	–	

**NOTE:** Pulse test: Pulse width  $\leq 300\mu S$ , duty cycle  $\leq 2\%$

**ELECTRICAL CHARACTERISTICS (Control part)**

(Ta=25°C unless otherwise specified)

Characteristic	Symbol	Test condition	Min.	Typ.	Max.	Unit
<b>REFERENCE SECTION</b>						
Output voltage <sup>(1)</sup>	V <sub>ref</sub>	Ta=25°C	4.80	5.00	5.20	V
Temperature Stability <sup>(1)(2)</sup>	V <sub>ref</sub> /ΔT	-25°C≤Ta≤+85°C	-	0.3	0.6	mV/°C
<b>OSCILLATOR SECTION</b>						
Initial accuracy	F <sub>OSC</sub>	Ta=25°C	61	67	73	kHz
Frequency change with temperature <sup>(2)</sup>	ΔF/ΔT	-25°C≤Ta≤+85°C	-	±5	±10	%
<b>PWM SECTION</b>						
Maximum duty cycle	D <sub>max</sub>	-	74	77	80	%
<b>FEEDBACK SECTION</b>						
Feedback source current	I <sub>FB</sub>	Ta=25°C, 0V≤V <sub>fb</sub> ≤3V	0.7	0.9	1.1	mA
Shutdown delay current	I <sub>delay</sub>	Ta=25°C, 5V≤V <sub>fb</sub> ≤V <sub>SD</sub>	4.0	5.0	6.0	μA
<b>OVER CURRENT PROTECTION SECTION</b>						
Over current protection	I <sub>L</sub> (max)	Max. inductor current	1.05	1.2	1.35	A
<b>UVLO SECTION</b>						
Start threshold voltage	V <sub>th</sub> (H)	-	14	15	16	V
Minimum operating voltage	V <sub>th</sub> (L)	After turn on	9	10	11	V
<b>TOTAL STANDBY CURRENT SECTION</b>						
Start current	I <sub>ST</sub>	V <sub>CC</sub> =14V	0.1	0.3	0.45	mA
Operating supply current (control part only)	I <sub>OPR</sub>	Ta=25°C	6	12	18	mA
V <sub>CC</sub> zener voltage	V <sub>Z</sub>	I <sub>CC</sub> =20mA	30	32.5	35	V
<b>SHUTDOWN SECTION</b>						
Shutdown Feedback voltage	V <sub>SD</sub>	-	6.9	7.5	8.1	V
Thermal shutdown temperature (T <sub>j</sub> ) <sup>(1)</sup>	T <sub>SD</sub>	-	140	160	-	°C
Over voltage protection voltage	V <sub>OVp</sub>	-	23	25	28	V

**NOTES:**

1. These parameters, although guaranteed, are not 100% tested in production
2. These parameters, although guaranteed, are tested in EDS (wafer test) process

## TYPICAL PERFORMANCE CHARACTERISTICS

(These characteristic graphs are normalized at  $T_a=25^\circ\text{C}$ )

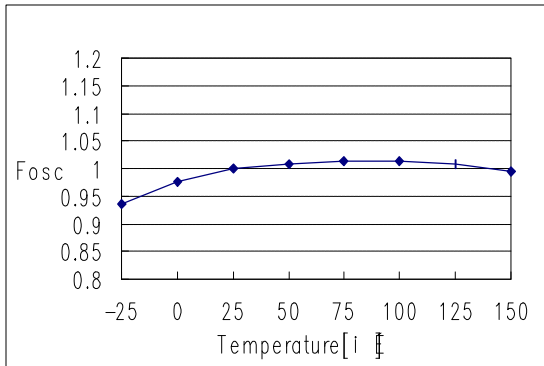

**Figure 1. Operating Frequency**

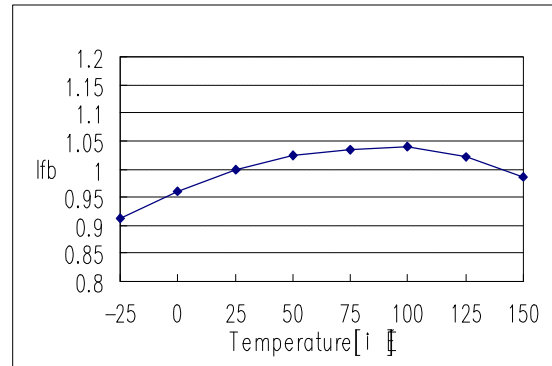

**Figure 2. Feedback Source Current**

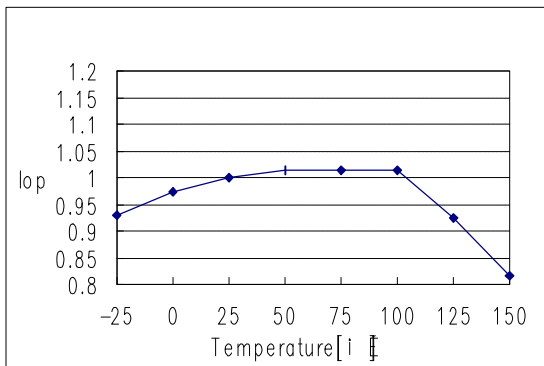

**Figure 3. Operating Current**

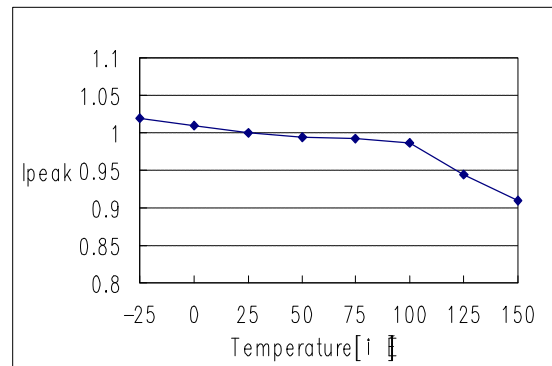

**Figure 4. Max. Inductor Current**

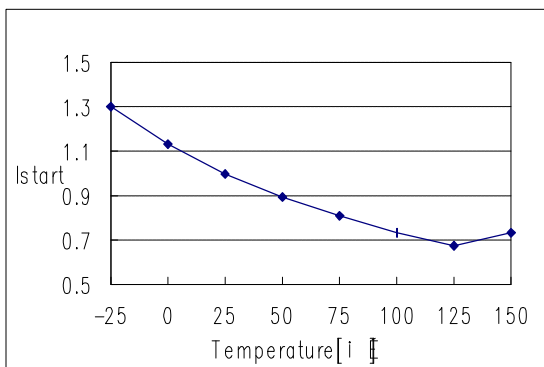

**Figure 5. Start up Current**

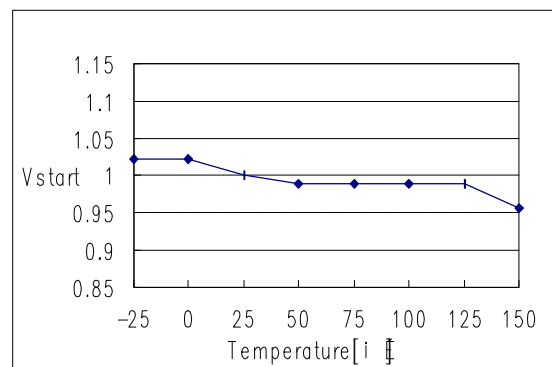

**Figure 6. Start Threshold Voltage**

**TYPICAL PERFORMANCE CHARACTERISTICS (Continued)**

(These characteristic graphs are normalized at  $T_a=25^\circ\text{C}$ )

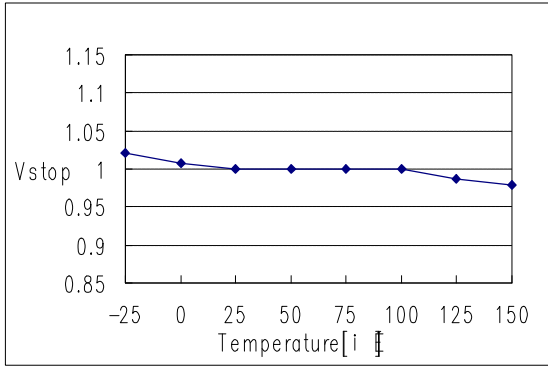

**Figure 7. Stop Threshold Voltage**

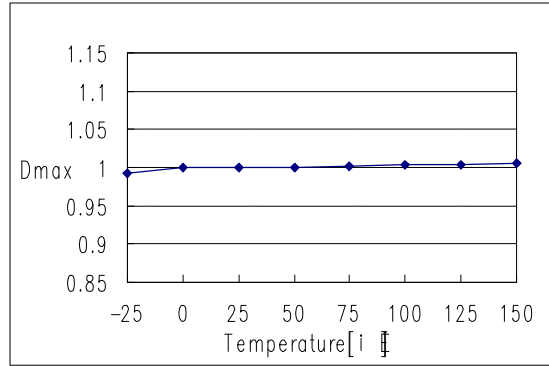

**Figure 8. Maximum Duty Cycle**

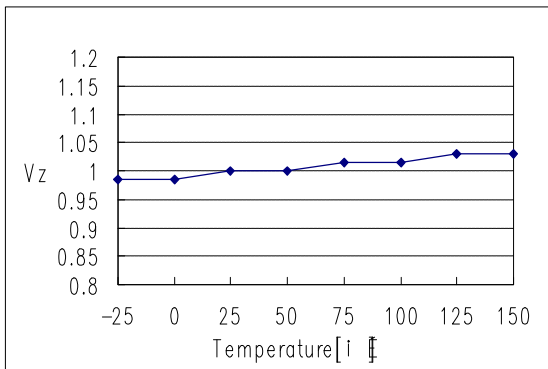

**Figure 9. V<sub>CC</sub> Zener Voltage**

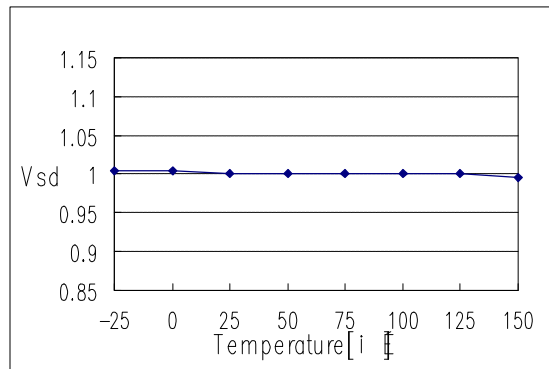

**Figure 10. Shutdown Feedback Voltage**

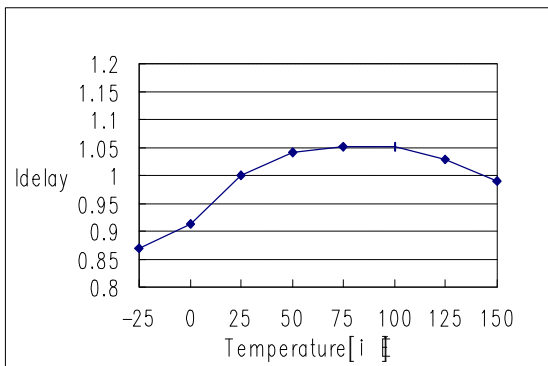

**Figure 11. Shutdown Delay Current**

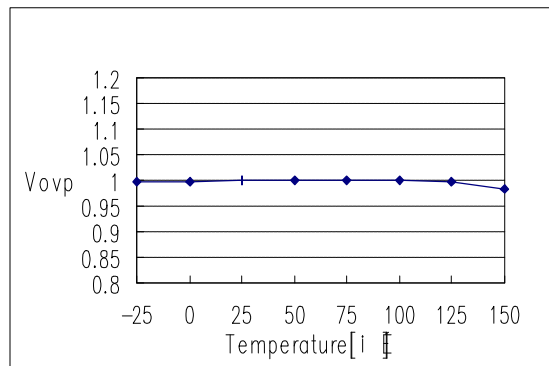

**Figure 12. Over Voltage Protection**

**TYPICAL PERFORMANCE CHARACTERISTICS (Continued)**

(These characteristic graphs are normalized at  $T_a=25^\circ\text{C}$ )

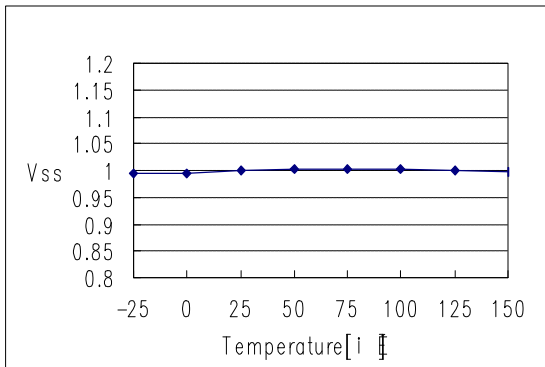

**Figure 13. Soft Start Voltage**

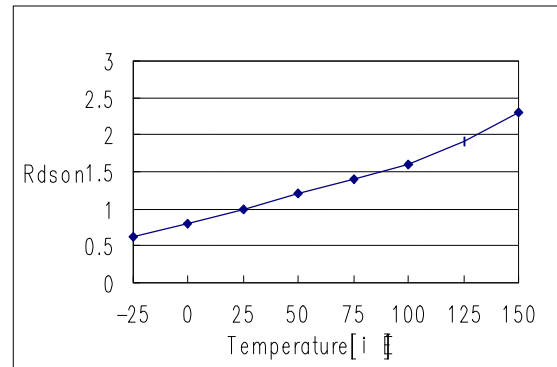

**Figure 14. Drain Source Turn-on Resistance**

## TRADEMARKS

The following are registered and unregistered trademarks Fairchild Semiconductor owns or is authorized to use and is not intended to be an exhaustive list of all such trademarks.

ACEx™	ISOPLANAR™	UHC™
CoolFET™	MICROWIRE™	VCX™
CROSSVOLT™	POP™	
E <sup>2</sup> CMOS™	PowerTrench™	
FACT™	QST™	
FACT Quiet Series™	Quiet Series™	
FAST®	SuperSOT™-3	
FASTr™	SuperSOT™-6	
GTO™	SuperSOT™-8	
HiSeC™	TinyLogic™	

## DISCLAIMER

FAIRCHILD SEMICONDUCTOR RESERVES THE RIGHT TO MAKE CHANGES WITHOUT FURTHER NOTICE TO ANY PRODUCTS HEREIN TO IMPROVE RELIABILITY, FUNCTION OR DESIGN. FAIRCHILD DOES NOT ASSUME ANY LIABILITY ARISING OUT OF THE APPLICATION OR USE OF ANY PRODUCT OR CIRCUIT DESCRIBED HEREIN; NEITHER DOES IT CONVEY ANY LICENSE UNDER ITS PATENT RIGHTS, NOR THE RIGHTS OF OTHERS.

## LIFE SUPPORT POLICY

FAIRCHILD'S PRODUCTS ARE NOT AUTHORIZED FOR USE AS CRITICAL COMPONENTS IN LIFE SUPPORT DEVICES OR SYSTEMS WITHOUT THE EXPRESS WRITTEN APPROVAL OF FAIRCHILD SEMICONDUCTOR CORPORATION. As used herein:

1. Life support devices or systems are devices or systems which, (a) are intended for surgical implant into the body, or (b) support or sustain life, or (c) whose failure to perform when properly used in accordance with instructions for use provided in the labeling, can be reasonably expected to result in significant injury to the user.
2. A critical component is any component of a life support device or system whose failure to perform can be reasonably expected to cause the failure of the life support device or system, or to affect its safety or effectiveness.

## PRODUCT STATUS DEFINITIONS

### Definition of Terms

Datasheet Identification	Product Status	Definition
Advance Information	Formative or In Design	This datasheet contains the design specifications for product development. Specifications may change in any manner without notice.
Preliminary	First Production	This datasheet contains preliminary data, and supplementary data will be published at a later date. Fairchild Semiconductor reserves the right to make changes at any time without notice in order to improve design.
No Identification Needed	Full Production	This datasheet contains final specifications. Fairchild Semiconductor reserves the right to make changes at any time without notice in order to improve design.
Obsolete	Not In Production	This datasheet contains specifications on a product that has been discontinued by Fairchild semiconductor. The datasheet is printed for reference information only.