

# SDRAM Unbuffered Module

168pin Unbuffered Module based on 256Mb E-die  
62/72-bit Non ECC/ECC

Revision 1.4

May 2004

\* Samsung Electronics reserves the right to change products or specification without notice.



*Rev. 1.4 May 2004*

**Revision History**

**Revision 1.0 (June, 2003)**

- First release

**Revision 1.1 (September, 2003)**

- Corrected Typo

**Revision 1.2 (February, 2004)**

- Corrected typo.

**Revision 1.3 (March, 2004)**

- Modified DC Characteristics Notes.

**Revision 1.4 (May, 2004)**

- Added Note 5. sentence of tRDL parameter

# 128MB, 256MB, 512MB Unbuffered DIMM

SDRAM

## 168Pin Unbuffered DIMM based on 256Mb E-die (x8, x16)

### Ordering Information

Part Number	Density	Organization	Component Composition	Component Package	Height
M366S1654ETS-C7A	128MB	16M x 64	16Mx16(K4S561632E) * 4EA	54-TSOP(II)	1,000mil
M366S3253ETS-C7A	256MB	32M x 64	32Mx8(K4S560832E) * 8EA		1,375mil
M366S3253ETU-C7A	256MB	32M x 64	32Mx8(K4S560832E) * 8EA		1,125mil
M374S3253ETS-C7A	256MB	32M x 72	32Mx8(K4S560832E) * 9EA		1,375mil
M374S3253ETU-C7A	256MB	32M x 72	32Mx8(K4S560832E) * 9EA		1,125mil
M366S6453ETS-C7A	512MB	64M x 64	32Mx8(K4S560832E)*16EA		1,375mil
M366S6453ETU-C7A	512MB	64M x 64	32Mx8(K4S560832E)*16EA		1,125mil
M374S6453ETS-C7A	512MB	64M x 72	32Mx8(K4S560832E)*18EA		1,375mil
M374S6453ETU-C7A	512MB	64M x 72	32Mx8(K4S560832E)*18EA		1,125mil

### Operating Frequencies

	7A	
	@CL3	@CL2
Maximum Clock Frequency	133MHz(7.5ns)	100MHz(10ns)
CL-tRCD-tRP(clock)	3 - 3 - 3	2 - 2 - 2

### Feature

- Burst mode operation
- Auto & self refresh capability (8192 Cycles/64ms)
- LVTTTL compatible inputs and outputs
- Single 3.3V ± 0.3V power supply
- MRS cycle with address key programs Latency (Access from column address)  
Burst length (1, 2, 4, 8 & Full page)  
Data scramble (Sequential & Interleave)
- All inputs are sampled at the positive going edge of the system clock
- Serial presence detect with EEPROM



Rev. 1.4 May 2004

# 128MB, 256MB, 512MB Unbuffered DIMM

# SDRAM

## PIN CONFIGURATIONS (Front side/back side)

Pin	Front	Pin	Front	Pin	Front	Pin	Back	Pin	Back	Pin	Back
1	VSS	29	DQM1	57	DQ18	85	VSS	113	DQM5	141	DQ50
2	DQ0	30	**CS0	58	DQ19	86	DQ32	114	**CS1	142	DQ51
3	DQ1	31	DU	59	VDD	87	DQ33	115	RAS	143	VDD
4	DQ2	32	VSS	60	DQ20	88	DQ34	116	VSS	144	DQ52
5	DQ3	33	A0	61	NC	89	DQ35	117	A1	145	NC
6	VDD	34	A2	62	*VREF	90	VDD	118	A3	146	*VREF
7	DQ4	35	A4	63	**CKE1	91	DQ36	119	A5	147	REGE
8	DQ5	36	A6	64	VSS	92	DQ37	120	A7	148	VSS
9	DQ6	37	A8	65	DQ21	93	DQ38	121	A9	149	DQ53
10	DQ7	38	A10/AP	66	DQ22	94	DQ39	122	BA0	150	DQ54
11	DQ8	39	BA1	67	DQ23	95	DQ40	123	A11	151	DQ55
12	VSS	40	VDD	68	VSS	96	VSS	124	VDD	152	VSS
13	DQ9	41	VDD	69	DQ24	97	DQ41	125	**CLK1	153	DQ56
14	DQ10	42	**CLK0	70	DQ25	98	DQ42	126	A12	154	DQ57
15	DQ11	43	VSS	71	DQ26	99	DQ43	127	VSS	155	DQ58
16	DQ12	44	DU	72	DQ27	100	DQ44	128	**CKE0	156	DQ59
17	DQ13	45	**CS2	73	VDD	101	DQ45	129	**CS3	157	VDD
18	VDD	46	DQM2	74	DQ28	102	VDD	130	DQM6	158	DQ60
19	DQ14	47	DQM3	75	DQ29	103	DQ46	131	DQM7	159	DQ61
20	DQ15	48	DU	76	DQ30	104	DQ47	132	*A13	160	DQ62
21	CB0	49	VDD	77	DQ31	105	CB4	133	VDD	161	DQ63
22	CB1	50	NC	78	VSS	106	CB5	134	NC	162	VSS
23	VSS	51	NC	79	**CLK2	107	VSS	135	NC	163	**CLK3
24	NC	52	CB2	80	NC	108	NC	136	CB6	164	NC
25	NC	53	CB3	81	NC	109	NC	137	CB7	165	SA0
26	VDD	54	VSS	82	SDA	110	VDD	138	VSS	166	SA1
27	WE	55	DQ16	83	SCL	111	CAS	139	DQ48	167	SA2
28	DQM0	56	DQ17	84	VDD	112	DQM4	140	DQ49	168	VDD

- Note :**
- \* These pins are not used in this module.
  - Pins 82,83,165,166,167 should be NC in the system which does not support SPD.
  - Pins 21,22,52,53,105,106,136,137 are used only ECC(x72) Module.
  - \*\* About these pins, Refer to the Block Diagram of each.

## Pin Description

Pin Name	Function	Pin Name	Function
A0 ~ A12	Address input (Multiplexed)	DQM0 ~ 7	DQM
BA0 ~ BA1	Select bank	VDD	Power supply (3.3V)
DQ0 ~ DQ63	Data input/output	VSS	Ground
CB0 ~ CB7	Check bit (Data-in/data-out)	VREF	Power supply for reference
CLK0 ~ 3	Clock input	REGE	Register enable
CKE0, CKE1	Clock enable input	SDA	Serial data I/O
CS0 ~ CS3	Chip select input	SCL	Serial clock
RAS	Row address strobe	SA0 ~ 2	Address in EEPROM
CAS	Column address strobe	DU	Don't use
WE	Write enable	NC	No connection

\* SAMSUNG ELECTRONICS CO., Ltd. reserves the right to change products and specifications without notice.



Rev. 1.4 May 2004

## PIN CONFIGURATION DESCRIPTION

Pin	Name	Input Function
CLK	<i>System clock</i>	Active on the positive going edge to sample all inputs.
$\overline{\text{CS}}$	<i>Chip select</i>	Disables or enables device operation by masking or enabling all inputs except CLK, CKE and DQM
CKE	<i>Clock enable</i>	Masks system clock to freeze operation from the next clock cycle. CKE should be enabled at least one cycle prior to new command. Disable input buffers for power down in standby. CKE should be enabled 1CLK+tss prior to valid command.
A0 ~ A12	<i>Address</i>	Row/column addresses are multiplexed on the same pins. Row address : RA0 ~ RA12 Column address : (x8 : CA0 ~ CA9), (x16 : CA0 ~ CA8)
BA0 ~ BA1	<i>Bank select address</i>	Selects bank to be activated during row address latch time. Selects bank for read/write during column address latch time.
$\overline{\text{RAS}}$	<i>Row address strobe</i>	Latches row addresses on the positive going edge of the CLK with $\overline{\text{RAS}}$ low. Enables row access & precharge.
$\overline{\text{CAS}}$	<i>Column address strobe</i>	Latches column addresses on the positive going edge of the CLK with $\overline{\text{CAS}}$ low. Enables column access.
$\overline{\text{WE}}$	<i>Write enable</i>	Enables write operation and row precharge. Latches data in starting from $\overline{\text{CAS}}$ , $\overline{\text{WE}}$ active.
DQM0 ~ 7	<i>Data input/output mask</i>	Makes data output Hi-Z, tSHZ after the clock and masks the output. Blocks data input when DQM active. (Byte masking)
REGE	<i>Register enable</i>	The device operates in the transparent mode when REGE is low. When REGE is high, the device operates in the registered mode. In registered mode, the Address and control inputs are latched if CLK is held at a high or low logic level. the inputs are stored in the latch/flip-flop on the rising edge of CLK. REGE is tied to VDD through 10K ohm Resistor on PCB. So if REGE of module is floating, this module will be operated as registered mode.
DQ0 ~ 63	<i>Data input/output</i>	Data inputs/outputs are multiplexed on the same pins.
CB0 ~ 7	<i>Check bit</i>	Check bits for ECC.
VDD/VSS	<i>Power supply/ground</i>	Power and ground for the input buffers and the core logic.

# 128MB, 256MB, 512MB Unbuffered DIMM

# SDRAM

128MB, 16Mx64 Module (M366S1654ETS) (Populated as 1 bank of x16 SDRAM Module)

## FUNCTIONAL BLOCK DIAGRAM

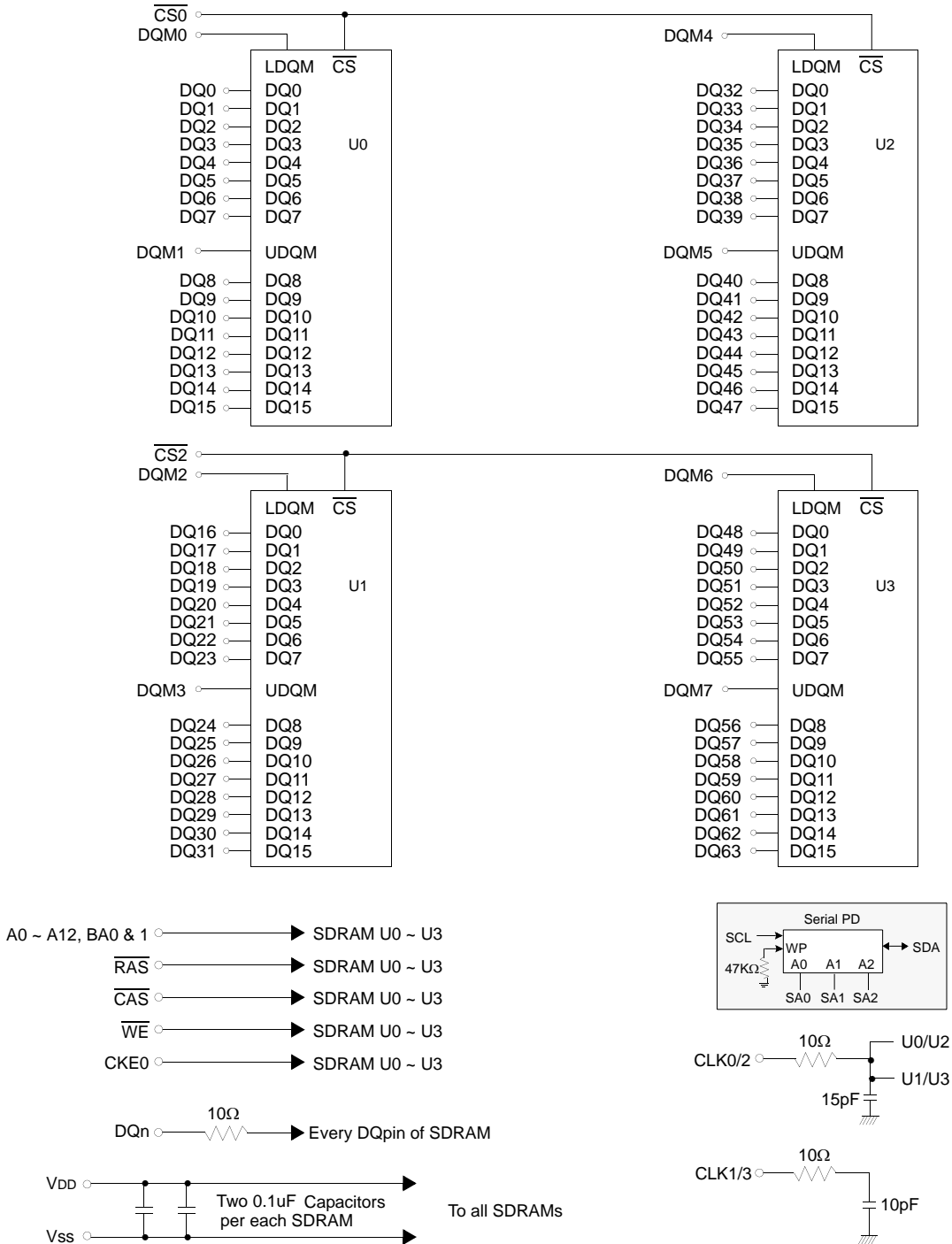

# 128MB, 256MB, 512MB Unbuffered DIMM

# SDRAM

256MB, 32Mx64 Non ECC Module(M366S3253ETS(U))(Populated as 1 bank of x8 SDRAM Module)

## FUNCTIONAL BLOCK DIAGRAM

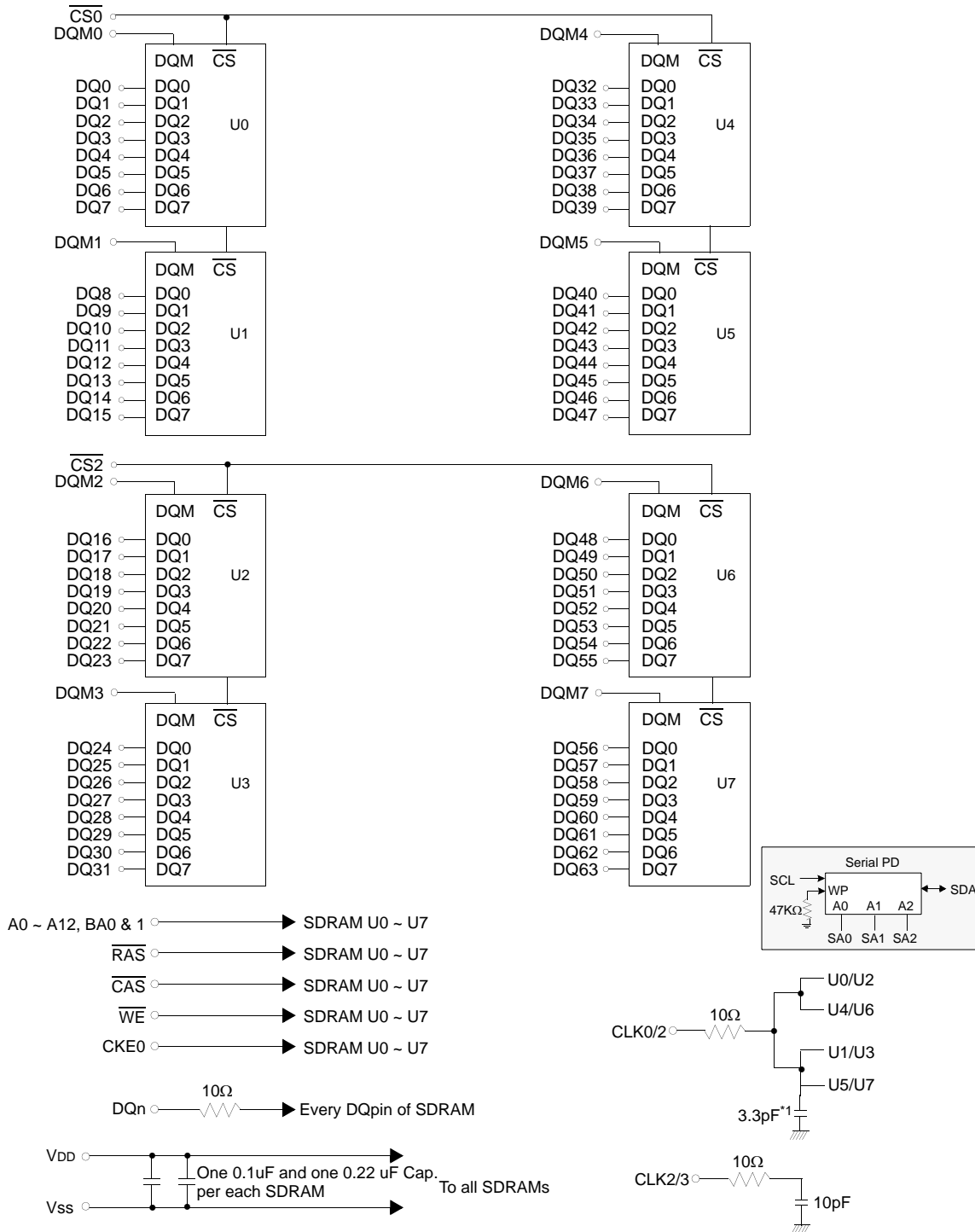

Rev. 1.4 May 2004

# 128MB, 256MB, 512MB Unbuffered DIMM

# SDRAM

## 256MB, 32Mx72 ECC Module (M374S3253ETS(U)) (Populated as 1 bank of x8 SDRAM Module) FUNCTIONAL BLOCK DIAGRAM

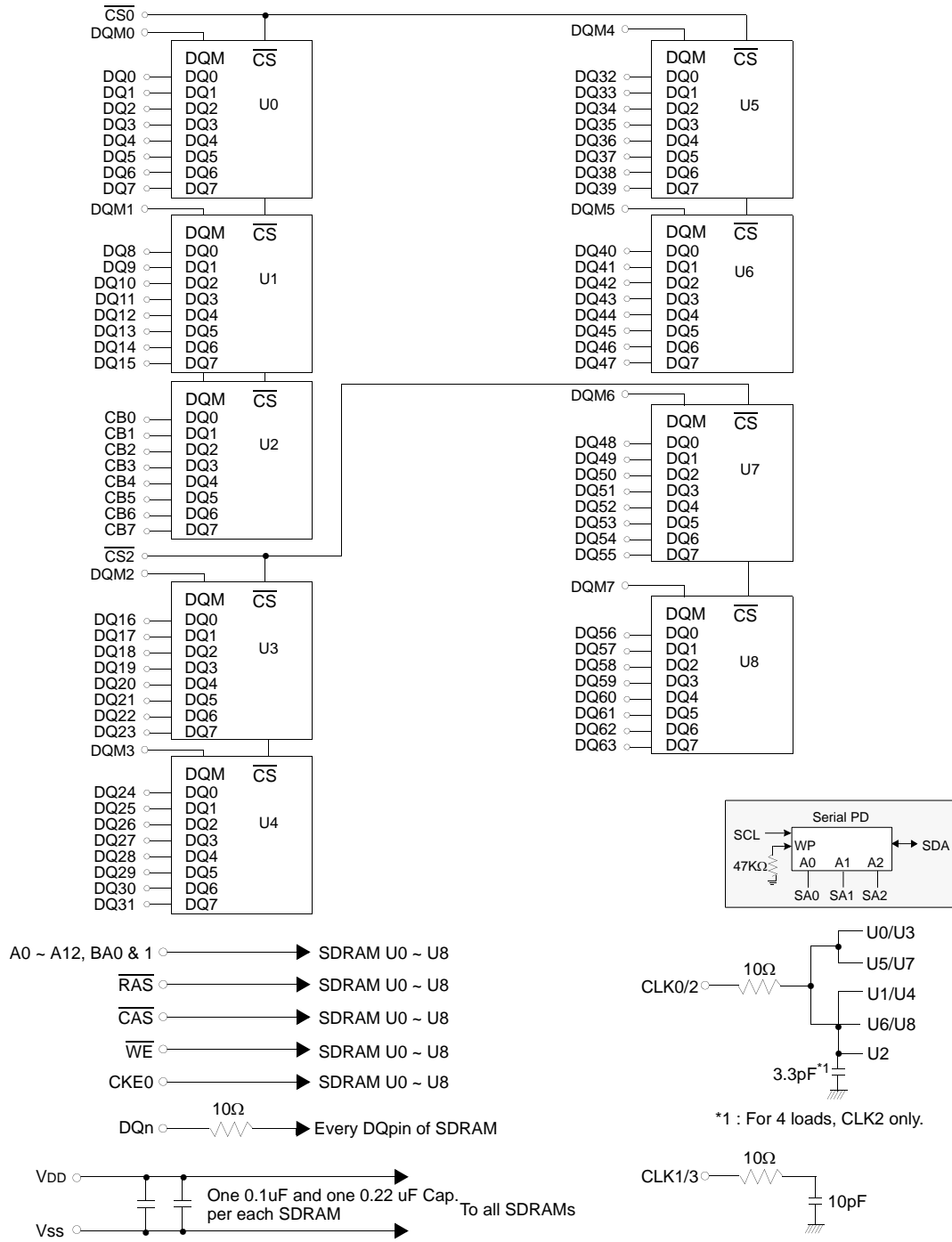

Rev. 1.4 May 2004



# 128MB, 256MB, 512MB Unbuffered DIMM

# SDRAM

## 512MB, 64Mx64 Non ECC Module (M366S6453ETS(U)) (Populated as 2 bank of x8 SDRAM Module) FUNCTIONAL BLOCK DIAGRAM

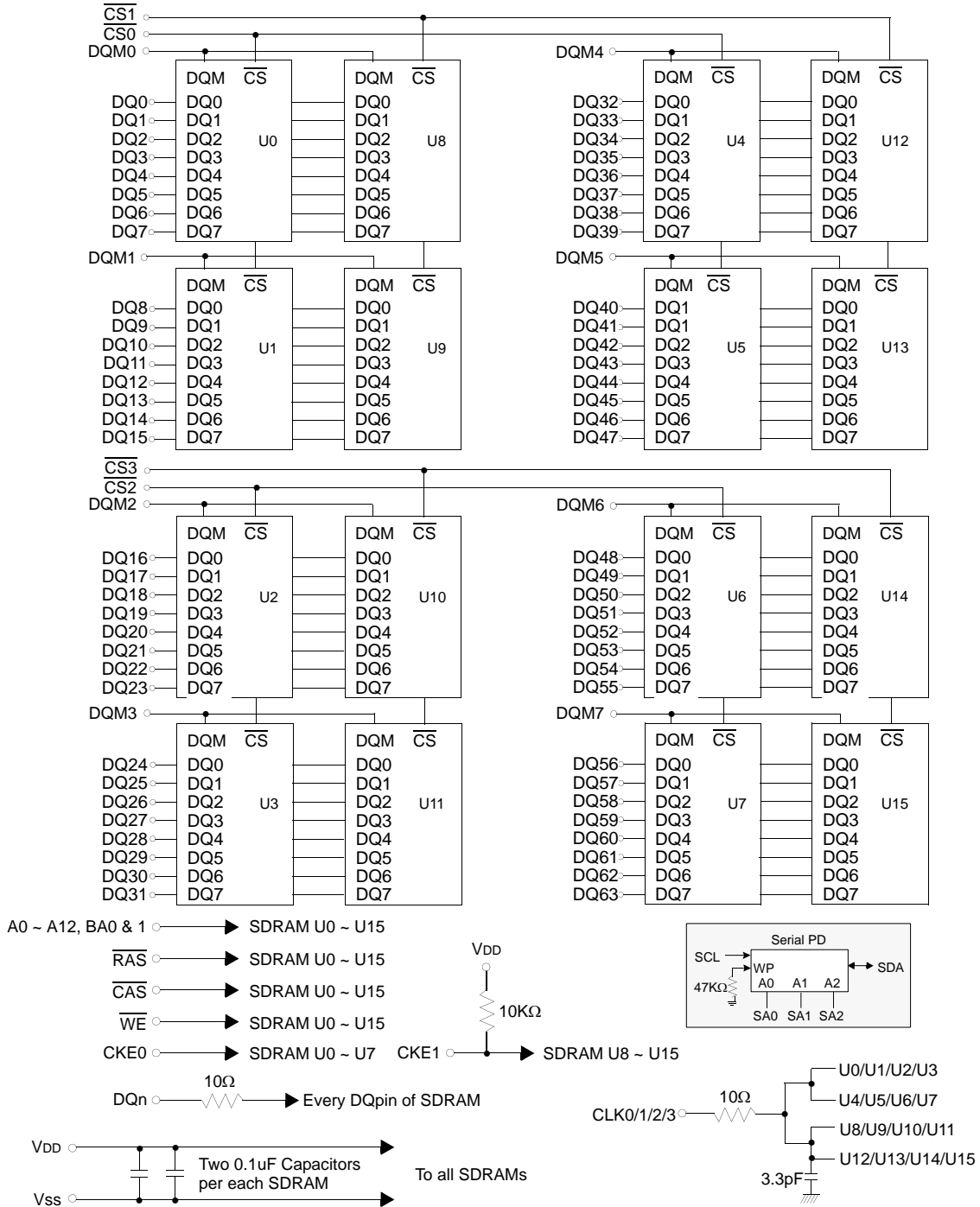

Rev. 1.4 May 2004

# 128MB, 256MB, 512MB Unbuffered DIMM

# SDRAM

## 512MB, 64Mx72 ECC Module (M374S6453ETS(U)) (Populated as 2 bank of x8 SDRAM Module) FUNCTIONAL BLOCK DIAGRAM

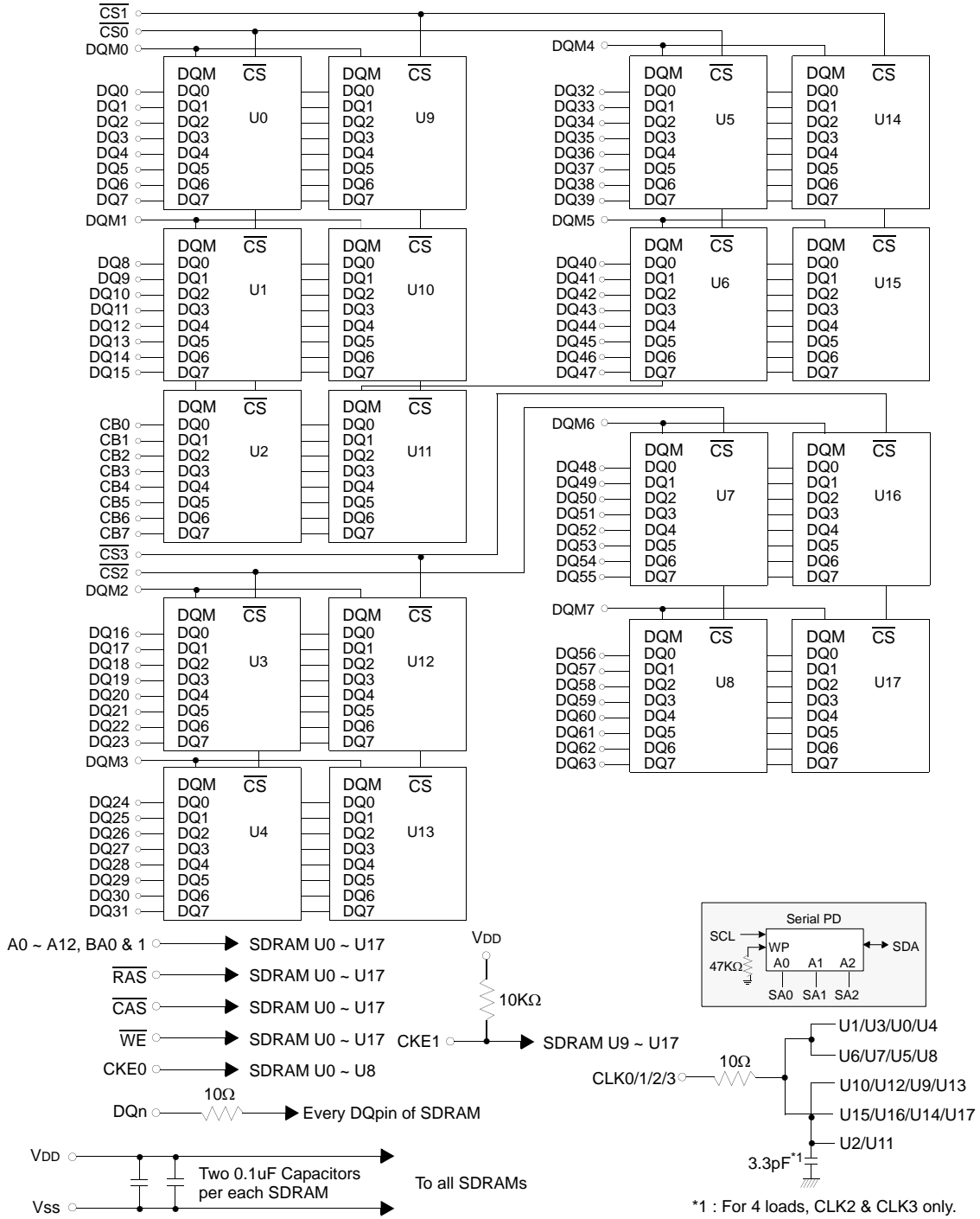

Rev. 1.4 May 2004

**ABSOLUTE MAXIMUM RATINGS**

Parameter	Symbol	Value	Unit
Voltage on any pin relative to Vss	V <sub>IN</sub> , V <sub>OUT</sub>	-1.0 ~ 4.6	V
Voltage on VDD supply relative to Vss	V <sub>DD</sub> , V <sub>DDQ</sub>	-1.0 ~ 4.6	V
Storage temperature	T <sub>STG</sub>	-55 ~ +150	°C
Power dissipation	P <sub>D</sub>	1.0 * # of component	W
Short circuit current	I <sub>OS</sub>	50	mA

**Note :** Permanent device damage may occur if "ABSOLUTE MAXIMUM RATINGS" are exceeded.  
 Functional operation should be restricted to recommended operating condition.  
 Exposure to higher than recommended voltage for extended periods of time could affect device reliability.

**DC OPERATING CONDITIONS AND CHARACTERISTICS**

Recommended operating conditions (Voltage referenced to Vss = 0V, T<sub>A</sub> = 0 to 70°C)

Parameter	Symbol	Min	Typ	Max	Unit	Note
Supply voltage	V <sub>DD</sub>	3.0	3.3	3.6	V	
Input high voltage	V <sub>IH</sub>	2.0	3.0	V <sub>DDQ</sub> +0.3	V	1
Input low voltage	V <sub>IL</sub>	-0.3	0	0.8	V	2
Output high voltage	V <sub>OH</sub>	2.4	-	-	V	I <sub>OH</sub> = -2mA
Output low voltage	V <sub>OL</sub>	-	-	0.4	V	I <sub>OL</sub> = 2mA
Input leakage current	I <sub>LI</sub>	-10	-	10	uA	3

**Notes :** 1. V<sub>IH</sub> (max) = 5.6V AC. The overshoot voltage duration is ≤ 3ns.  
 2. V<sub>IL</sub> (min) = -2.0V AC. The undershoot voltage duration is ≤ 3ns.  
 3. Any input 0V ≤ V<sub>IN</sub> ≤ V<sub>DDQ</sub>.  
 Input leakage currents include Hi-Z output leakage for all bi-directional buffers with Tri-State outputs.

**CAPACITANCE** (V<sub>DD</sub> = 3.3V, T<sub>A</sub> = 23°C, f = 1MHz, V<sub>REF</sub> = 1.4V ± 200 mV)

Parameter	Sym- bol	M366S1654ETS		M366S3253ETS(U)		M366S6453ETS(U)		Unit
		Min	Max	Min	Max	Min	Max	
Input capacitance (A <sub>0</sub> ~ A <sub>11</sub> )	C <sub>IN1</sub>	15	25	25	45	45	85	pF
Input capacitance ( $\overline{\text{RAS}}$ , $\overline{\text{CAS}}$ , $\overline{\text{WE}}$ )	C <sub>IN2</sub>	15	25	25	45	45	85	pF
Input capacitance (CKE)	C <sub>IN3</sub>	15	25	25	45	25	45	pF
Input capacitance (CLK)	C <sub>IN4</sub>	10	13	15	21	15	21	pF
Input capacitance ( $\overline{\text{CS}}$ )	C <sub>IN5</sub>	10	15	15	25	15	25	pF
Input capacitance (DQM <sub>0</sub> ~ DQM <sub>7</sub> )	C <sub>IN6</sub>	8	10	8	12	10	15	pF
Data input/output capacitance (DQ <sub>0</sub> ~ DQ <sub>63</sub> )	C <sub>OUT</sub>	9	12	9	12	13	18	pF

Pin	Sym- bol	M374S3253ETS(U)		M374S6453ETS(U)		Unit
		Min	Max	Min	Max	
Input capacitance (A <sub>0</sub> ~ A <sub>11</sub> )	C <sub>IN1</sub>	28	50	50	95	pF
Input capacitance ( $\overline{\text{RAS}}$ , $\overline{\text{CAS}}$ , $\overline{\text{WE}}$ )	C <sub>IN2</sub>	28	50	50	95	pF
Input capacitance (CKE)	C <sub>IN3</sub>	28	50	28	50	pF
Input capacitance (CLK)	C <sub>IN4</sub>	18	25	18	25	pF
Input capacitance ( $\overline{\text{CS}}$ )	C <sub>IN5</sub>	18	30	18	30	pF
Input capacitance (DQM <sub>0</sub> ~ DQM <sub>7</sub> )	C <sub>IN6</sub>	8	10	13	20	pF
Data input/output capacitance (DQ <sub>0</sub> ~ DQ <sub>63</sub> )	C <sub>OUT</sub>	9	12	13	18	pF



# 128MB, 256MB, 512MB Unbuffered DIMM

# SDRAM

## DC CHARACTERISTICS

### M366S1654ETS (16M x 64, 128MB Module)

(Recommended operating condition unless otherwise noted, TA = 0 to 70°C)

Parameter	Symbol	Test Condition	Version	Unit	Note
			7A		
Operating current (One bank active)	I <sub>CC1</sub>	Burst length = 1 t <sub>RC</sub> ≥ t <sub>RC</sub> (min) I <sub>O</sub> = 0 mA	360	mA	1
Precharge standby current in power-down mode	I <sub>CC2P</sub>	CKE ≤ V <sub>IL</sub> (max), t <sub>CC</sub> = 10ns	8	mA	
	I <sub>CC2PS</sub>	CKE & CLK ≤ V <sub>IL</sub> (max), t <sub>CC</sub> = ∞	8		
Precharge standby current in non power-down mode	I <sub>CC2N</sub>	CKE ≥ V <sub>IH</sub> (min), CS ≥ V <sub>IH</sub> (min), t <sub>CC</sub> = 10ns Input signals are changed one time during 20ns	80	mA	
	I <sub>CC2NS</sub>	CKE ≥ V <sub>IH</sub> (min), CLK ≤ V <sub>IL</sub> (max), t <sub>CC</sub> = ∞ Input signals are stable	40		
Active standby current in power-down mode	I <sub>CC3P</sub>	CKE ≤ V <sub>IL</sub> (max), t <sub>CC</sub> = 10ns	25	mA	
	I <sub>CC3PS</sub>	CKE & CLK ≤ V <sub>IL</sub> (max), t <sub>CC</sub> = ∞	25		
Active standby current in non power-down mode (One bank active)	I <sub>CC3N</sub>	CKE ≥ V <sub>IH</sub> (min), CS ≥ V <sub>IH</sub> (min), t <sub>CC</sub> = 10ns Input signals are changed one time during 20ns	100	mA	
	I <sub>CC3NS</sub>	CKE ≥ V <sub>IH</sub> (min), CLK ≤ V <sub>IL</sub> (max), t <sub>CC</sub> = ∞ Input signals are stable	100		
Operating current (Burst mode)	I <sub>CC4</sub>	I <sub>O</sub> = 0 mA Page burst 4Banks activated t <sub>CCD</sub> = 2CLKs	520	mA	1
Refresh current	I <sub>CC5</sub>	t <sub>RC</sub> ≥ t <sub>RC</sub> (min)	720	mA	2
Self refresh current	I <sub>CC6</sub>	CKE ≤ 0.2V	12	mA	

### M366S3253ETS(U) (32M x 64, 256MB Module)

(Recommended operating condition unless otherwise noted, TA = 0 to 70°C)

Parameter	Symbol	Test Condition	Version	Unit	Note
			7A		
Operating current (One bank active)	I <sub>CC1</sub>	Burst length = 1 t <sub>RC</sub> ≥ t <sub>RC</sub> (min) I <sub>O</sub> = 0 mA	640	mA	1
Precharge standby current in power-down mode	I <sub>CC2P</sub>	CKE ≤ V <sub>IL</sub> (max), t <sub>CC</sub> = 10ns	16	mA	
	I <sub>CC2PS</sub>	CKE & CLK ≤ V <sub>IL</sub> (max), t <sub>CC</sub> = ∞	16		
Precharge standby current in non power-down mode	I <sub>CC2N</sub>	CKE ≥ V <sub>IH</sub> (min), CS ≥ V <sub>IH</sub> (min), t <sub>CC</sub> = 10ns Input signals are changed one time during 20ns	160	mA	
	I <sub>CC2NS</sub>	CKE ≥ V <sub>IH</sub> (min), CLK ≤ V <sub>IL</sub> (max), t <sub>CC</sub> = ∞ Input signals are stable	80		
Active standby current in power-down mode	I <sub>CC3P</sub>	CKE ≤ V <sub>IL</sub> (max), t <sub>CC</sub> = 10ns	50	mA	
	I <sub>CC3PS</sub>	CKE & CLK ≤ V <sub>IL</sub> (max), t <sub>CC</sub> = ∞	50		
Active standby current in non power-down mode (One bank active)	I <sub>CC3N</sub>	CKE ≥ V <sub>IH</sub> (min), CS ≥ V <sub>IH</sub> (min), t <sub>CC</sub> = 10ns Input signals are changed one time during 20ns	200	mA	
	I <sub>CC3NS</sub>	CKE ≥ V <sub>IH</sub> (min), CLK ≤ V <sub>IL</sub> (max), t <sub>CC</sub> = ∞ Input signals are stable	200		
Operating current (Burst mode)	I <sub>CC4</sub>	I <sub>O</sub> = 0 mA Page burst 4Banks activated t <sub>CCD</sub> = 2CLKs	800	mA	1
Refresh current	I <sub>CC5</sub>	t <sub>RC</sub> ≥ t <sub>RC</sub> (min)	1,440	mA	2
Self refresh current	I <sub>CC6</sub>	CKE ≤ 0.2V	24	mA	

- Notes :**
1. Measured with outputs open.
  2. Refresh period is 64ms.
  3. Unless otherwise noted, input swing level is CMOS(V<sub>IH</sub>/V<sub>IL</sub>=V<sub>DDQ</sub>/V<sub>SSQ</sub>)



Rev. 1.4 May 2004

# 128MB, 256MB, 512MB Unbuffered DIMM

# SDRAM

## DC CHARACTERISTICS

### M374S3253ETS(U) (32M x 72, 256MB Module)

(Recommended operating condition unless otherwise noted, TA = 0 to 70°C)

Parameter	Symbol	Test Condition	Version	Unit	Note
			7A		
Operating current (One bank active)	I <sub>CC1</sub>	Burst length = 1 trc ≥ trc(min) I <sub>O</sub> = 0 mA	720	mA	1
Precharge standby current in power-down mode	I <sub>CC2P</sub>	CKE ≤ V <sub>IL</sub> (max), t <sub>CC</sub> = 10ns	18	mA	
	I <sub>CC2PS</sub>	CKE & CLK ≤ V <sub>IL</sub> (max), t <sub>CC</sub> = ∞	18		
Precharge standby current in non power-down mode	I <sub>CC2N</sub>	CKE ≥ V <sub>IH</sub> (min), CS ≥ V <sub>IH</sub> (min), t <sub>CC</sub> = 10ns Input signals are changed one time during 20ns	180	mA	
	I <sub>CC2NS</sub>	CKE ≥ V <sub>IH</sub> (min), CLK ≤ V <sub>IL</sub> (max), t <sub>CC</sub> = ∞ Input signals are stable	90		
Active standby current in power-down mode	I <sub>CC3P</sub>	CKE ≤ V <sub>IL</sub> (max), t <sub>CC</sub> = 10ns	54	mA	
	I <sub>CC3PS</sub>	CKE & CLK ≤ V <sub>IL</sub> (max), t <sub>CC</sub> = ∞	54		
Active standby current in non power-down mode (One bank active)	I <sub>CC3N</sub>	CKE ≥ V <sub>IH</sub> (min), CS ≥ V <sub>IH</sub> (min), t <sub>CC</sub> = 10ns Input signals are changed one time during 20ns	225	mA	
	I <sub>CC3NS</sub>	CKE ≥ V <sub>IH</sub> (min), CLK ≤ V <sub>IL</sub> (max), t <sub>CC</sub> = ∞ Input signals are stable	225		
Operating current (Burst mode)	I <sub>CC4</sub>	I <sub>O</sub> = 0 mA Page burst 4Banks activated t <sub>CCD</sub> = 2CLKs	900	mA	1
Refresh current	I <sub>CC5</sub>	trc ≥ trc(min)	1,620	mA	2
Self refresh current	I <sub>CC6</sub>	CKE ≤ 0.2V	27	mA	

### M366S6453ETS(U) (64M x 64, 512MB Module)

(Recommended operating condition unless otherwise noted, TA = 0 to 70°C)

Parameter	Symbol	Test Condition	Version	Unit	Note
			7A		
Operating current (One bank active)	I <sub>CC1</sub>	Burst length = 1 trc ≥ trc(min) I <sub>O</sub> = 0 mA	840	mA	1
Precharge standby current in power-down mode	I <sub>CC2P</sub>	CKE ≤ V <sub>IL</sub> (max), t <sub>CC</sub> = 10ns	32	mA	
	I <sub>CC2PS</sub>	CKE & CLK ≤ V <sub>IL</sub> (max), t <sub>CC</sub> = ∞	32		
Precharge standby current in non power-down mode	I <sub>CC2N</sub>	CKE ≥ V <sub>IH</sub> (min), CS ≥ V <sub>IH</sub> (min), t <sub>CC</sub> = 10ns Input signals are changed one time during 20ns	320	mA	
	I <sub>CC2NS</sub>	CKE ≥ V <sub>IH</sub> (min), CLK ≤ V <sub>IL</sub> (max), t <sub>CC</sub> = ∞ Input signals are stable	160		
Active standby current in power-down mode	I <sub>CC3P</sub>	CKE ≤ V <sub>IL</sub> (max), t <sub>CC</sub> = 10ns	96	mA	
	I <sub>CC3PS</sub>	CKE & CLK ≤ V <sub>IL</sub> (max), t <sub>CC</sub> = ∞	96		
Active standby current in non power-down mode (One bank active)	I <sub>CC3N</sub>	CKE ≥ V <sub>IH</sub> (min), CS ≥ V <sub>IH</sub> (min), t <sub>CC</sub> = 10ns Input signals are changed one time during 20ns	400	mA	
	I <sub>CC3NS</sub>	CKE ≥ V <sub>IH</sub> (min), CLK ≤ V <sub>IL</sub> (max), t <sub>CC</sub> = ∞ Input signals are stable	400		
Operating current (Burst mode)	I <sub>CC4</sub>	I <sub>O</sub> = 0 mA Page burst 4Banks activated t <sub>CCD</sub> = 2CLKs	1,000	mA	1
Refresh current	I <sub>CC5</sub>	trc ≥ trc(min)	1,620	mA	2
Self refresh current	I <sub>CC6</sub>	CKE ≤ 0.2V	48	mA	

- Notes :**
1. Measured with outputs open.
  2. Refresh period is 64ms.
  3. Unless otherwise noted, input swing level is CMOS(V<sub>IH</sub>/V<sub>IL</sub>=V<sub>DDQ</sub>/V<sub>SSQ</sub>)



Rev. 1.4 May 2004

# 128MB, 256MB, 512MB Unbuffered DIMM

# SDRAM

## DC CHARACTERISTICS

### M374S6453ETS(U) (64M x 72, 512MB Module)

(Recommended operating condition unless otherwise noted,  $T_A = 0$  to  $70^\circ\text{C}$ )

Parameter	Symbol	Test Condition	Version	Unit	Note
			7A		
Operating current (One bank active)	I <sub>CC1</sub>	Burst length = 1 $t_{RC} \geq t_{RC}(\text{min})$ $I_O = 0 \text{ mA}$	945	mA	1
Precharge standby current in power-down mode	I <sub>CC2P</sub>	$\text{CKE} \leq V_{IL}(\text{max}), t_{CC} = 10\text{ns}$	36	mA	
	I <sub>CC2PS</sub>	$\text{CKE} \ \& \ \text{CLK} \leq V_{IL}(\text{max}), t_{CC} = \infty$	36		
Precharge standby current in non power-down mode	I <sub>CC2N</sub>	$\text{CKE} \geq V_{IH}(\text{min}), \text{CS} \geq V_{IH}(\text{min}), t_{CC} = 10\text{ns}$ Input signals are changed one time during 20ns	360	mA	
	I <sub>CC2NS</sub>	$\text{CKE} \geq V_{IH}(\text{min}), \text{CLK} \leq V_{IL}(\text{max}), t_{CC} = \infty$ Input signals are stable	180		
Active standby current in power-down mode	I <sub>CC3P</sub>	$\text{CKE} \leq V_{IL}(\text{max}), t_{CC} = 10\text{ns}$	108	mA	
	I <sub>CC3PS</sub>	$\text{CKE} \ \& \ \text{CLK} \leq V_{IL}(\text{max}), t_{CC} = \infty$	108		
Active standby current in non power-down mode (One bank active)	I <sub>CC3N</sub>	$\text{CKE} \geq V_{IH}(\text{min}), \text{CS} \geq V_{IH}(\text{min}), t_{CC} = 10\text{ns}$ Input signals are changed one time during 20ns	450	mA	
	I <sub>CC3NS</sub>	$\text{CKE} \geq V_{IH}(\text{min}), \text{CLK} \leq V_{IL}(\text{max}), t_{CC} = \infty$ Input signals are stable	450		
Operating current (Burst mode)	I <sub>CC4</sub>	$I_O = 0 \text{ mA}$ Page burst 4Banks activated $t_{CCD} = 2\text{CLKs}$	1,125	mA	1
Refresh current	I <sub>CC5</sub>	$t_{RC} \geq t_{RC}(\text{min})$	1,845	mA	2
Self refresh current	I <sub>CC6</sub>	$\text{CKE} \leq 0.2\text{V}$	54	mA	

- Notes :**
1. Measured with outputs open.
  2. Refresh period is 64ms.
  3. Unless otherwise noted, input swing level is CMOS( $V_{IH}/V_{IL} = V_{DDQ}/V_{SSQ}$ )

# 128MB, 256MB, 512MB Unbuffered DIMM

# SDRAM

## AC OPERATING TEST CONDITIONS ( $V_{DD} = 3.3V \pm 0.3V$ , $T_A = 0$ to $70^\circ C$ )

Parameter	Value	Unit
AC input levels ( $V_{ih}/V_{il}$ )	2.4/0.4	V
Input timing measurement reference level	1.4	V
Input rise and fall time	$t_r/t_f = 1/1$	ns
Output timing measurement reference level	1.4	V
Output load condition	See Fig. 2	

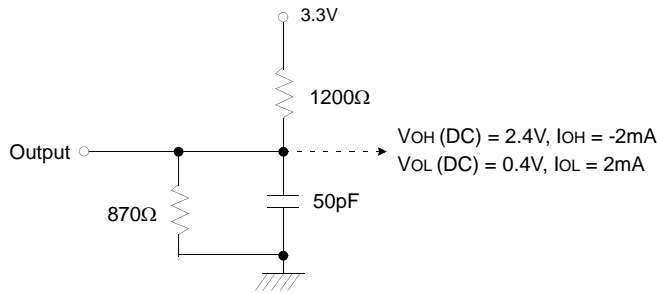

(Fig. 1) DC output load circuit

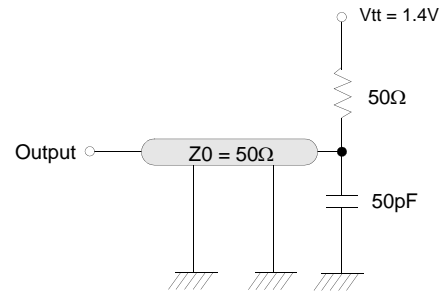

(Fig. 2) AC output load circuit

## OPERATING AC PARAMETER

(AC operating conditions unless otherwise noted)

Parameter	Symbol	Version	Unit	Note
		7A		
Row active to row active delay	$t_{RRD}(\min)$	15	ns	1
$\overline{RAS}$ to $\overline{CAS}$ delay	$t_{RCD}(\min)$	20	ns	1
Row precharge time	$t_{RP}(\min)$	20	ns	1
Row active time	$t_{RAS}(\min)$	45	ns	1
	$t_{RAS}(\max)$	100	us	
Row cycle time	$t_{RC}(\min)$	65	ns	1
Last data in to row precharge	$t_{RDL}(\min)$	2	CLK	2,5
Last data in to Active delay	$t_{DAL}(\min)$	2 CLK + $t_{RP}$	-	5
Last data in to new col. address delay	$t_{CDL}(\min)$	1	CLK	2
Last data in to burst stop	$t_{BDL}(\min)$	1	CLK	2
Col. address to col. address delay	$t_{CCD}(\min)$	1	CLK	3
Number of valid output data	CAS latency=3	2	ea	4
	CAS latency=2	1		

- Notes :**
1. The minimum number of clock cycles is determined by dividing the minimum time required with clock cycle time and then rounding off to the next higher integer.
  2. Minimum delay is required to complete write.
  3. All parts allow every cycle column address change.
  4. In case of row precharge interrupt, auto precharge and read burst stop.
  5. In 100MHz and below 100MHz operating conditions,  $t_{RDL}=1CLK$  and  $t_{DAL}=1CLK + 20ns$  is also supported. SAMSUNG recommends  $t_{RDL}=2CLK$  and  $t_{DAL}=2CLK + t_{RP}$ .

**AC CHARACTERISTICS** (AC operating conditions unless otherwise noted)

**REFER TO THE INDIVIDUAL COMPONENT, NOT THE WHOLE MODULE.**

Parameter		Symbol	7A		Unit	Note
			Min	Max		
CLK cycle time	CAS latency=3	tCC	7.5	1000	ns	1
	CAS latency=2		10			
CLK to valid output delay	CAS latency=3	tSAC		5.4	ns	1,2
	CAS latency=2			6		
Output data hold time	CAS latency=3	tOH	3		ns	2
	CAS latency=2		3			
CLK high pulse width		tCH	2.5		ns	3
CLK low pulse width		tCL	2.5		ns	3
Input setup time		tSS	1.5		ns	3
Input hold time		tSH	0.8		ns	3
CLK to output in Low-Z		tSLZ	1		ns	2
CLK to output in Hi-Z	CAS latency=3	tSHZ		5.4	ns	
	CAS latency=2			6		

- Notes :**
- Parameters depend on programmed CAS latency.
  - If clock rising time is longer than 1ns,  $(tr/2-0.5)$ ns should be added to the parameter.
  - Assumed input rise and fall time ( $tr$  &  $tf$ ) = 1ns.  
If  $tr$  &  $tf$  is longer than 1ns, transient time compensation should be considered, i.e.,  $[(tr + tf)/2-1]$ ns should be added to the parameter.



# 128MB, 256MB, 512MB Unbuffered DIMM

# SDRAM

## SIMPLIFIED TRUTH TABLE

(V=Valid, X=Don't care, H=Logic high, L=Logic low)

Command		CKEn-1	CKEn	$\overline{CS}$	$\overline{RAS}$	$\overline{CAS}$	$\overline{WE}$	DQM	BA0,1	A10/AP	A0 ~ A9, A11, A12	Note	
Register	Mode register set	H	X	L	L	L	L	X	OP code			1,2	
Refresh	Auto refresh	H	H	L	L	L	H	X	X			3	
	Entry		L									3	
	Self refresh	Exit	L	H	L	H	H	H	X	X			3
					H	X	X	X					3
Bank active & row addr.		H	X	L	L	H	H	X	V	Row address			
Read & column address	Auto precharge disable	H	X	L	H	L	H	X	V	L	Column address	4	
	Auto precharge enable									H		4,5	
Write & column address	Auto precharge disable	H	X	L	H	L	L	X	V	L	Column address	4	
	Auto precharge enable									H		4,5	
Burst stop		H	X	L	H	H	L	X	X			6	
Precharge	Bank selection	H	X	L	L	H	L	X	V	L	X		
	All banks								X	H			
Clock suspend or active power down	Entry	H	L	H	X	X	X	X	X				
	Exit			L	H	X	X					X	X
Precharge power down mode	Entry	H	L	H	X	X	X	X	X				
				L	H	H	H						
	Exit	L	H	H	X	X	X	X					
				L	V	V	V						
DQM		H	X					V	X		7		
No operation command		H	X	H	X	X	X	X	X				
				L	H	H	H						

**Notes :** 1. OP Code : Operand code

- A0 ~ A12 & BA0 ~ BA1 : Program keys. (@ MRS)
- MRS can be issued only at all banks precharge state.  
A new command can be issued after 2 clock cycles of MRS.
- Auto refresh functions are as same as CBR refresh of DRAM.  
The automatical precharge without row precharge command is meant by "Auto".  
Auto/self refresh can be issued only at all banks precharge state.
- BA0 ~ BA1 : Bank select addresses.  
If both BA0 and BA1 are "Low" at read, write, row active and precharge, bank A is selected.  
If BA0 is "High" and BA1 is "Low" at read, write, row active and precharge, bank B is selected.  
If BA0 is "Low" and BA1 is "High" at read, write, row active and precharge, bank C is selected.  
If both BA0 and BA1 are "High" at read, write, row active and precharge, bank D is selected.  
If A10/AP is "High" at row precharge, BA0 and BA1 is ignored and all banks are selected.
- During burst read or write with auto precharge, new read/write command can not be issued.  
Another bank read/write command can be issued after the end of burst.  
New row active of the associated bank can be issued at tRP after the end of burst.
- Burst stop command is valid at every burst length.
- DQM sampled at positive going edge of a CLK and masks the data-in at the very CLK (Write DQM latency is 0), but makes Hi-Z state the data-out of 2 CLK cycles after. (Read DQM latency is 2)



Rev. 1.4 May 2004

# 128MB, 256MB, 512MB Unbuffered DIMM

# SDRAM

## PACKAGE DIMENSIONS : 16Mx64 (M366S1654ETS)

Units : Inches (Millimeters)

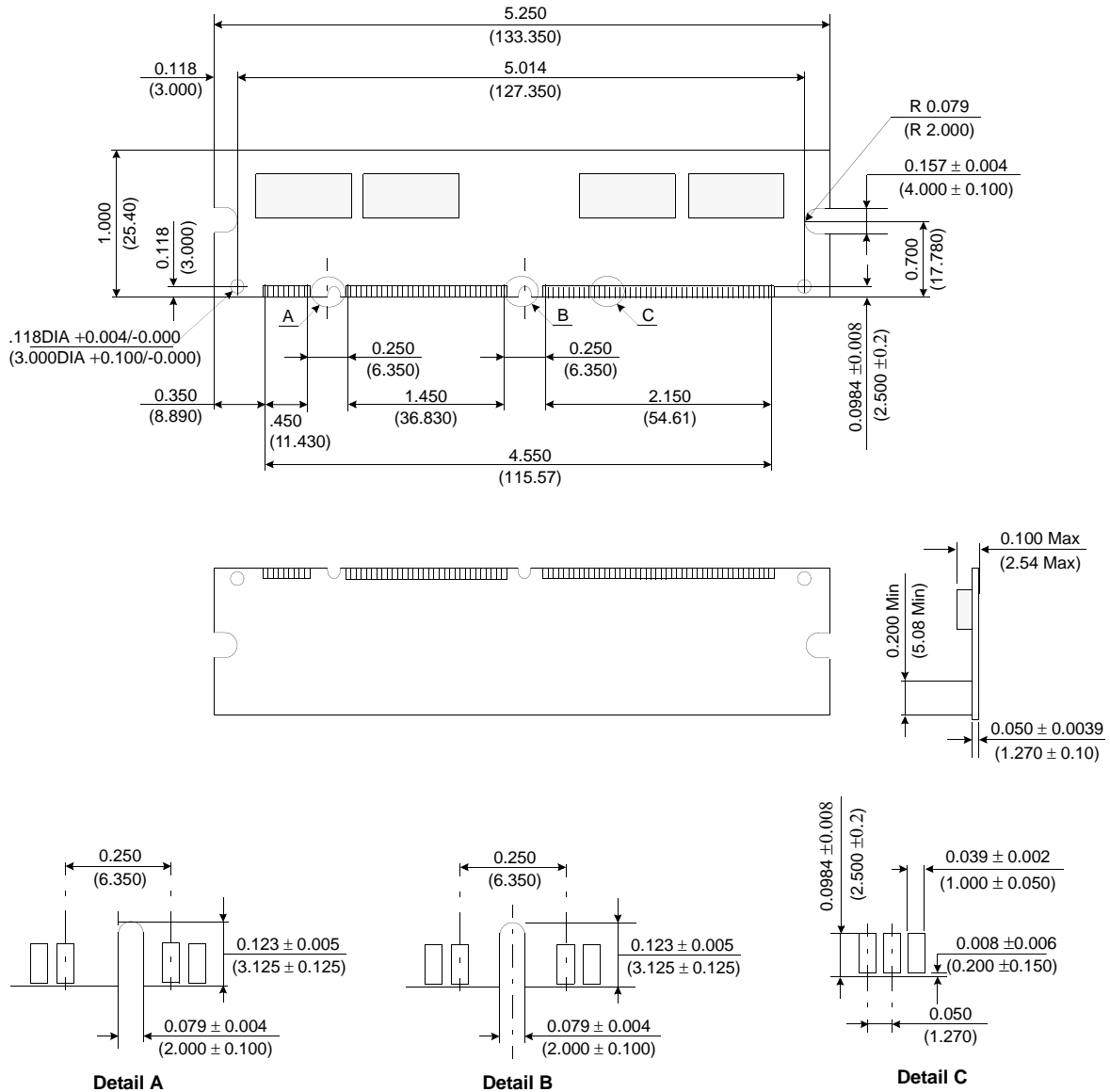

Tolerances : ± .005(.13) unless otherwise specified

The used device is 16Mx16 SDRAM, TSOPII  
SDRAM Part No. : K4S561632E

# 128MB, 256MB, 512MB Unbuffered DIMM

# SDRAM

PACKAGE DIMENSIONS : 32Mx64 (M366S3253ETS)

Units : Inches (Millimeters)

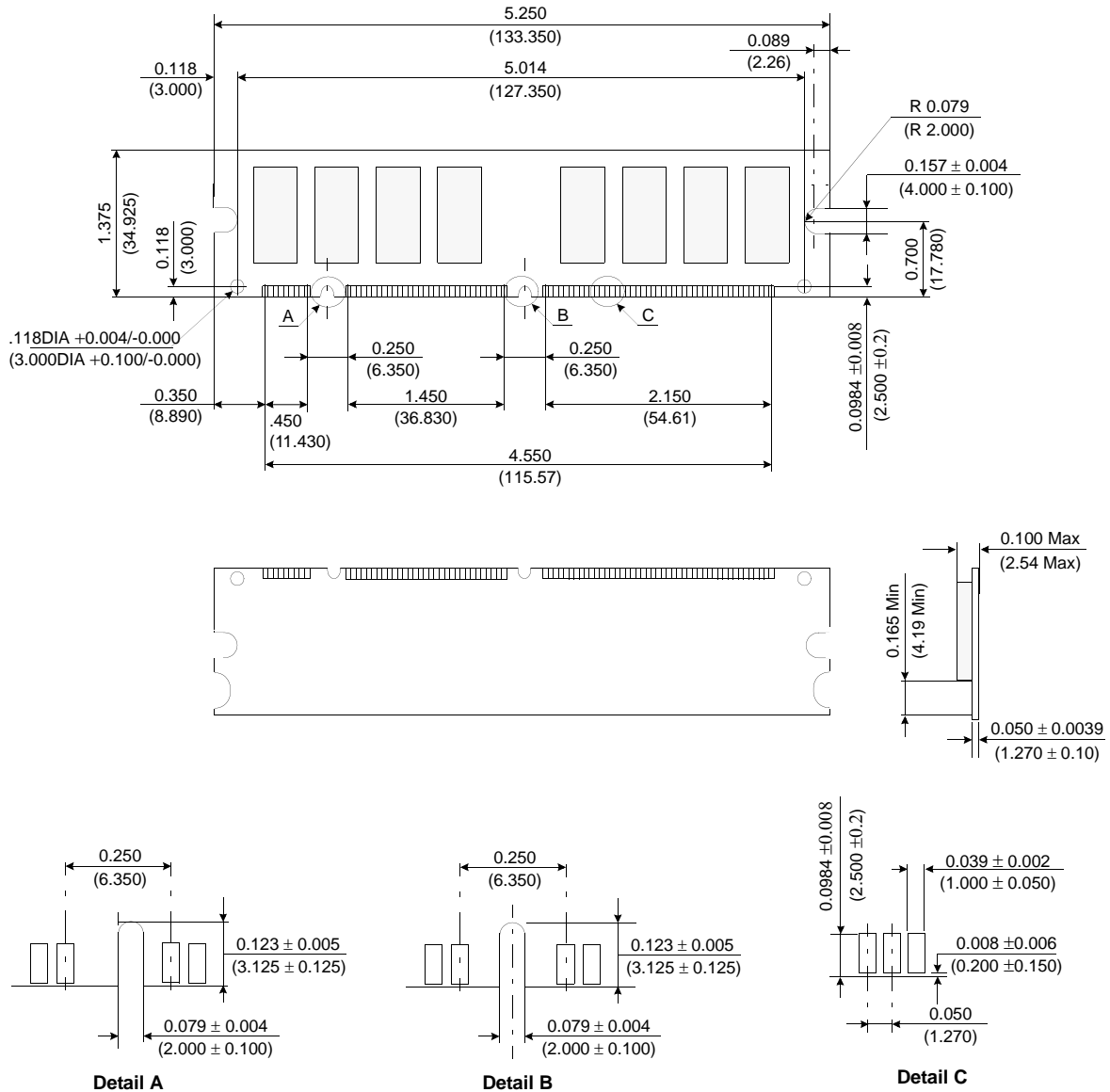

Tolerances :  $\pm .005(.13)$  unless otherwise specified

The used device is 32Mx8 SDRAM, TSOP11  
SDRAM Part No. : K4S560832E

# 128MB, 256MB, 512MB Unbuffered DIMM

# SDRAM

## PACKAGE DIMENSIONS :32Mx64 (M366S3253ETU)

Units : Inches (Millimeters)

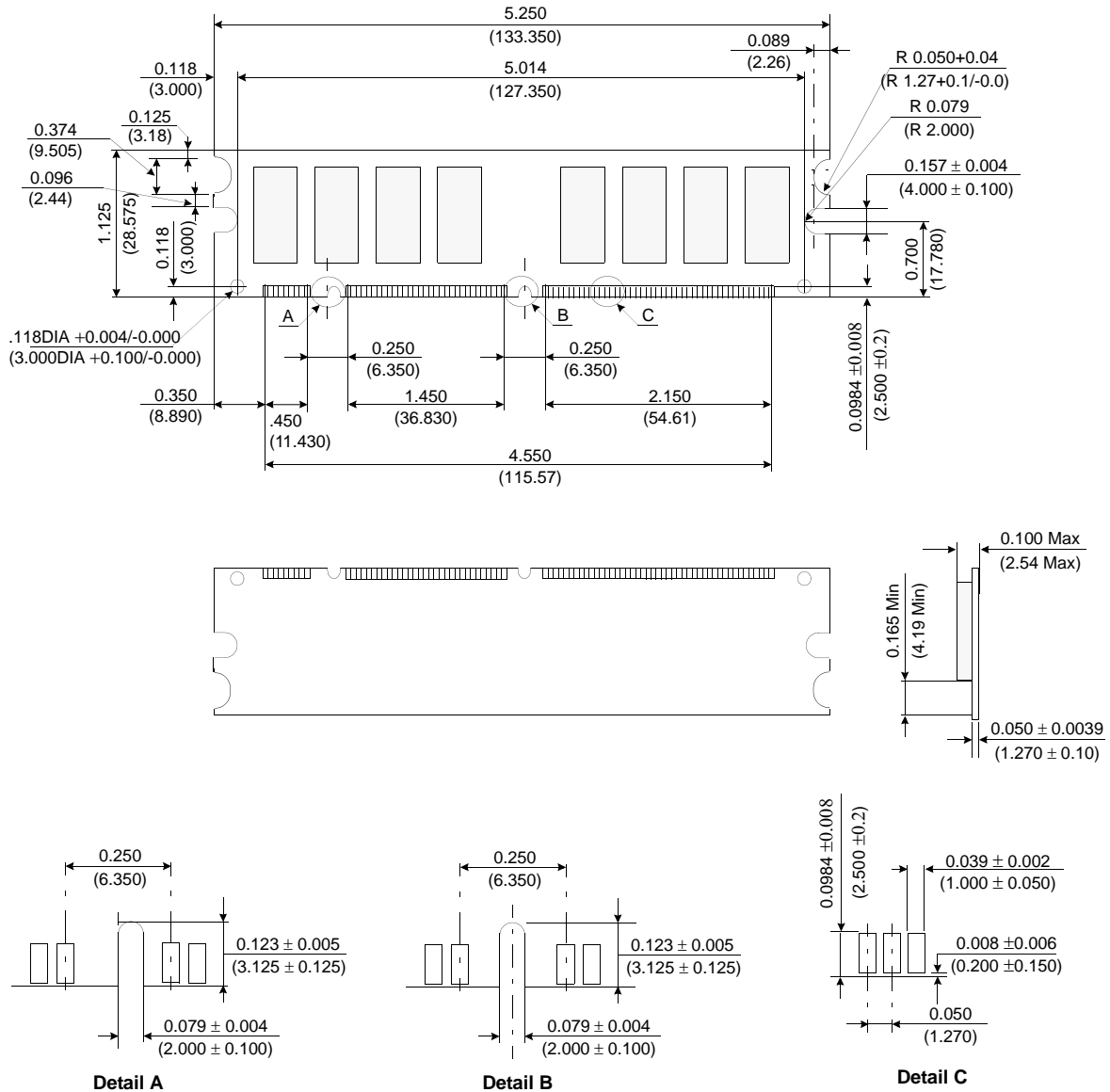

Tolerances : ± .005(.13) unless otherwise specified

The used device is 32Mx8 SDRAM, TSOPII  
SDRAM Part No. : K4S560832E

# 128MB, 256MB, 512MB Unbuffered DIMM

# SDRAM

## PACKAGE DIMENSIONS : 32Mx72 (M374S3253ETS)

Units : Inches (Millimeters)

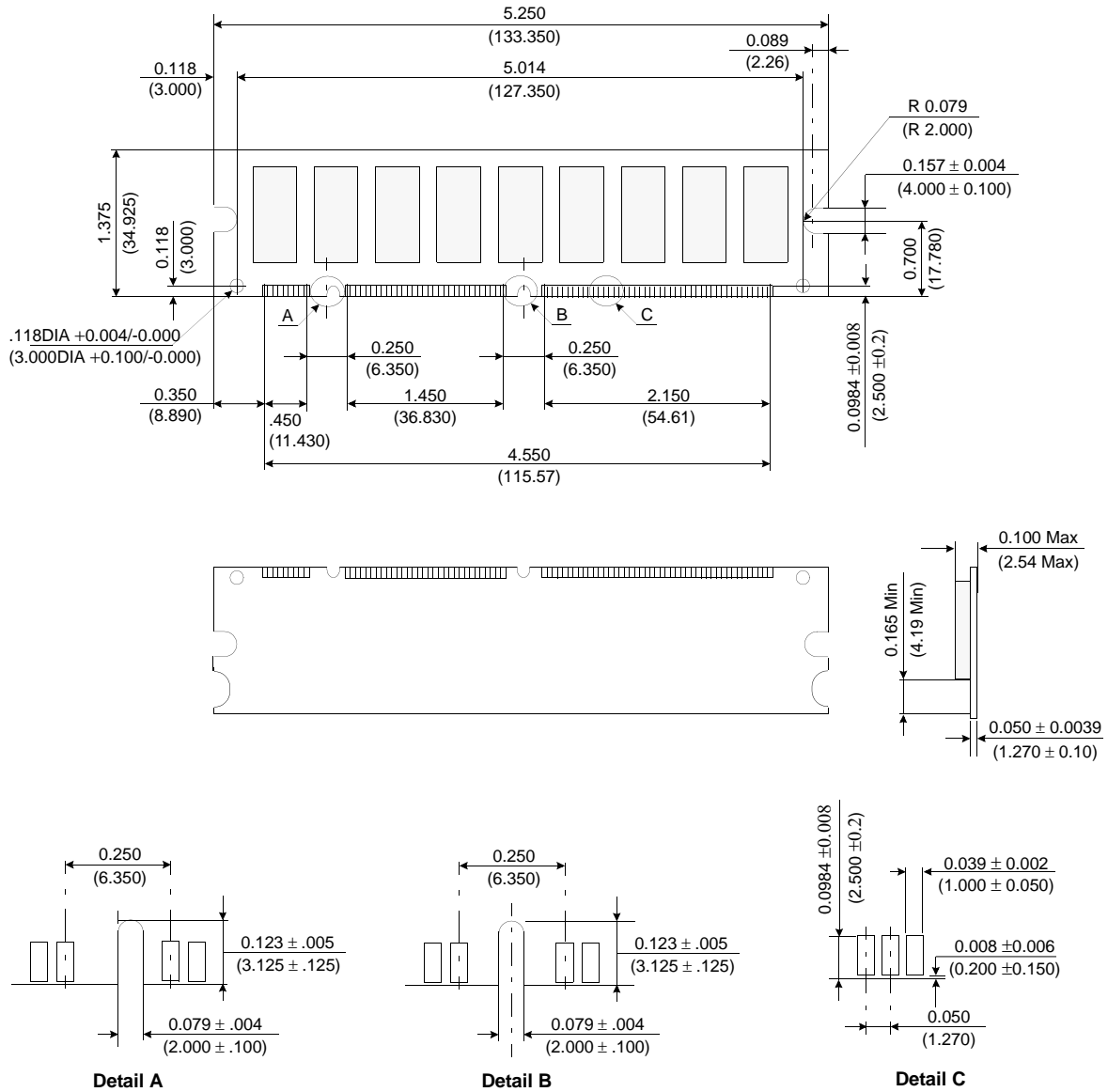

Tolerances : ± .005(.13) unless otherwise specified

The used device is 32Mx8 SDRAM, TSOP11  
SDRAM Part No. : K4S560832E

# 128MB, 256MB, 512MB Unbuffered DIMM

# SDRAM

PACKAGE DIMENSIONS : 32Mx72 (M374S3253ETU)

Units : Inches (Millimeters)

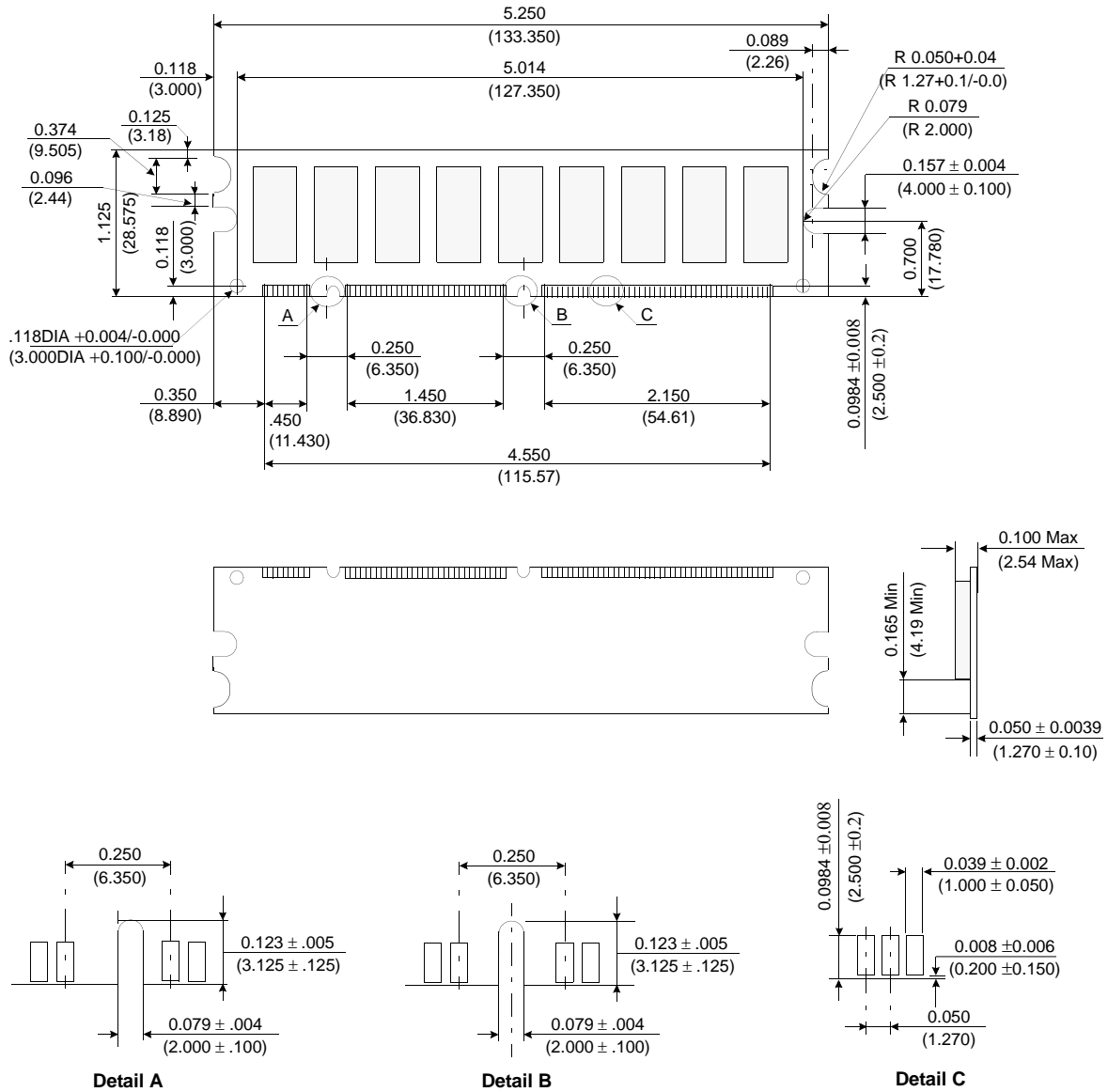

Tolerances : ± .005(.13) unless otherwise specified

The used device is 32Mx8 SDRAM, TSOP11  
SDRAM Part No. : K4S560832E

# 128MB, 256MB, 512MB Unbuffered DIMM

# SDRAM

## PACKAGE DIMENSIONS : 64Mx64 (M366S6453ETS)

Units : Inches (Millimeters)

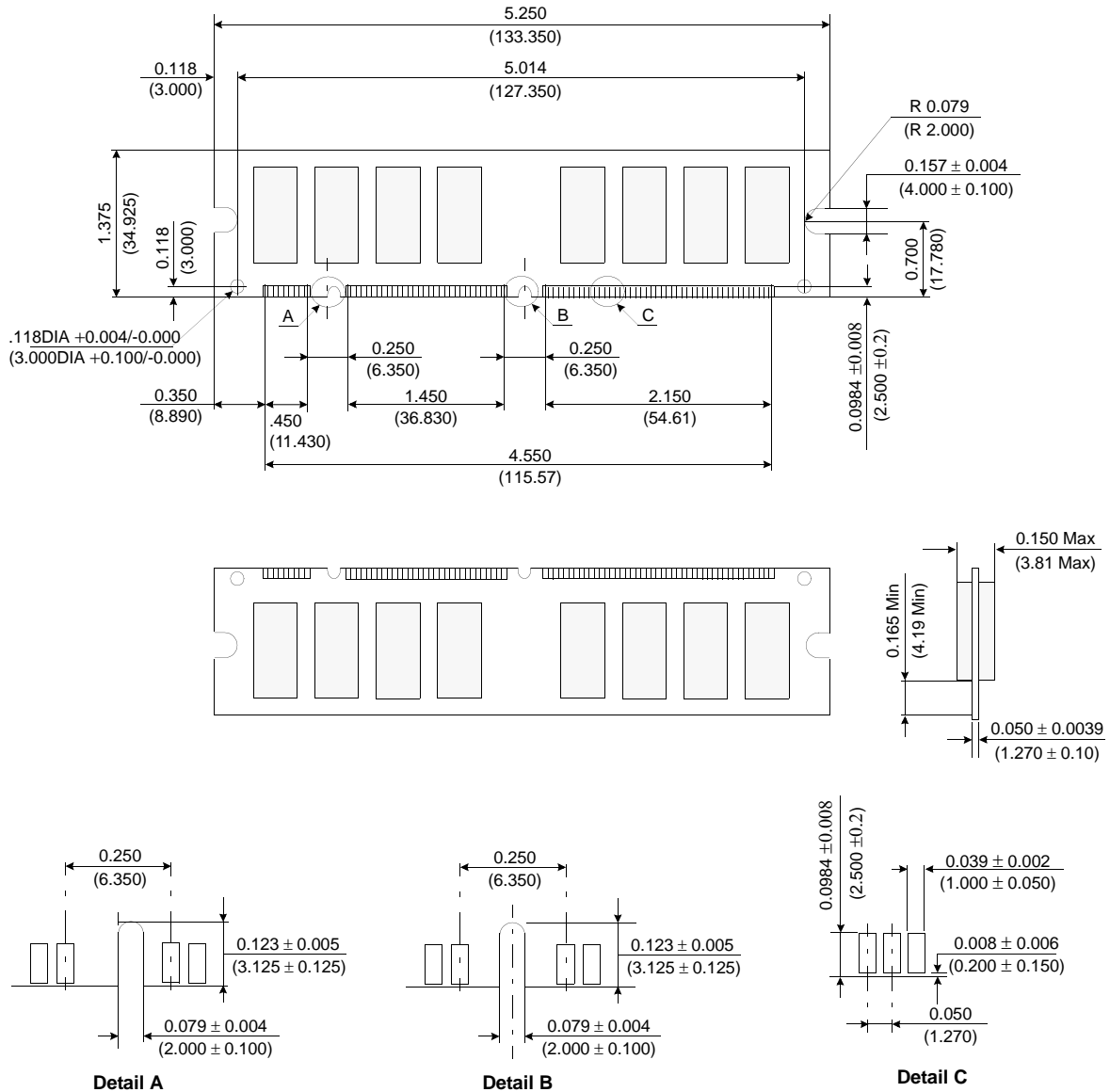

Tolerances :  $\pm .005(.13)$  unless otherwise specified

The used device is 32Mx8 SDRAM, TSOP11  
SDRAM Part No. : K4S560832E

# 128MB, 256MB, 512MB Unbuffered DIMM

SDRAM

PACKAGE DIMENSIONS : 64Mx64 (M366S6453ETU)

Units : Inches (Millimeters)

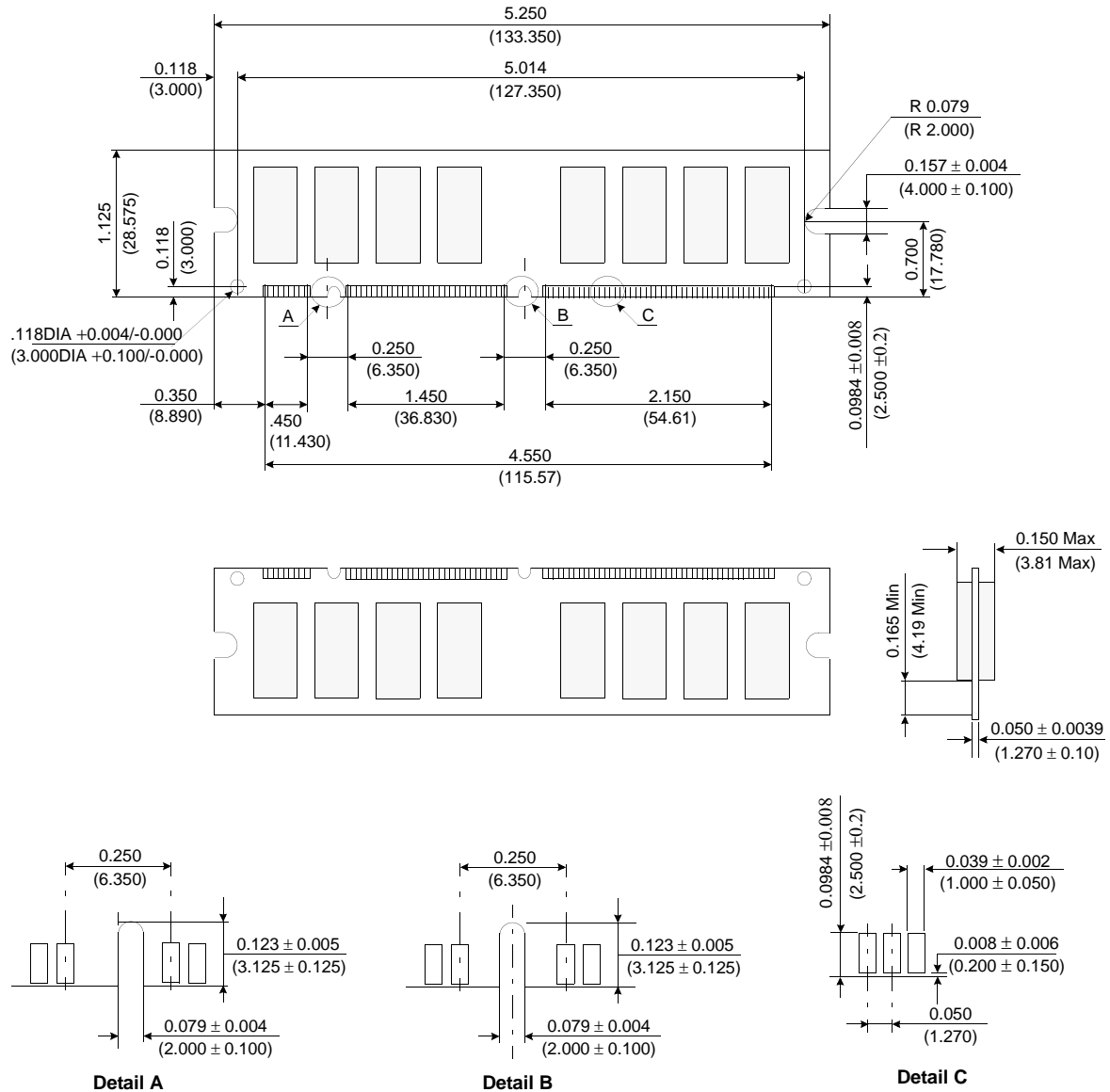

Tolerances : ± .005(.13) unless otherwise specified

The used device is 32Mx8 SDRAM, TSOPII  
SDRAM Part No. : K4S560832E



Rev. 1.4 May 2004



# 128MB, 256MB, 512MB Unbuffered DIMM

SDRAM

PACKAGE DIMENSIONS : 64Mx72 (M374S6453ETS)

Units : Inches (Millimeters)

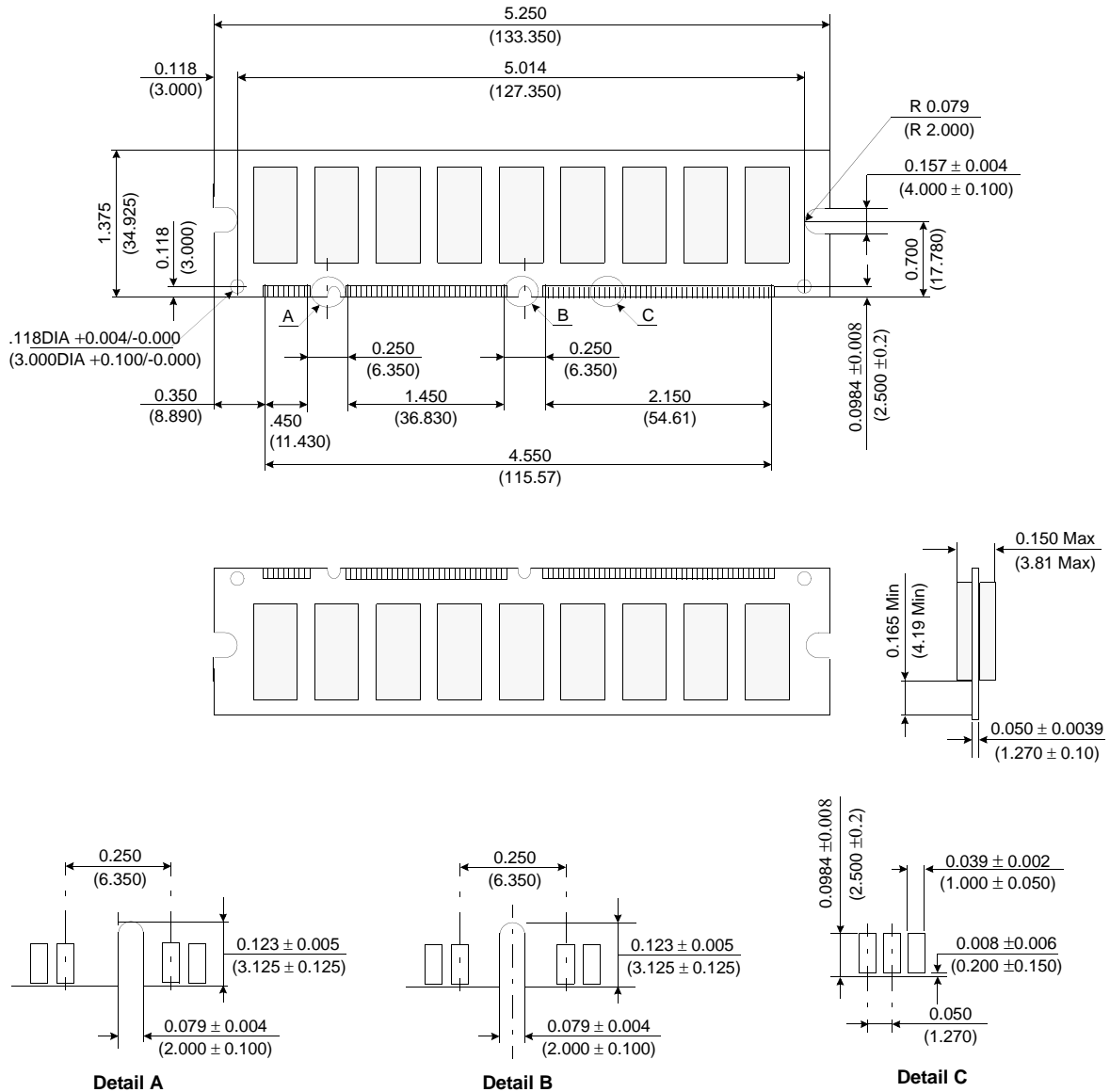

Tolerances : ± 0.005(.13) unless otherwise specified

The used device is 32Mx8 SDRAM, TSOP11  
SDRAM Part No. : K4S560832E



Rev. 1.4 May 2004

# 128MB, 256MB, 512MB Unbuffered DIMM

# SDRAM

PACKAGE DIMENSIONS : 64Mx72 (M374S6453ETU)

Units : Inches (Millimeters)

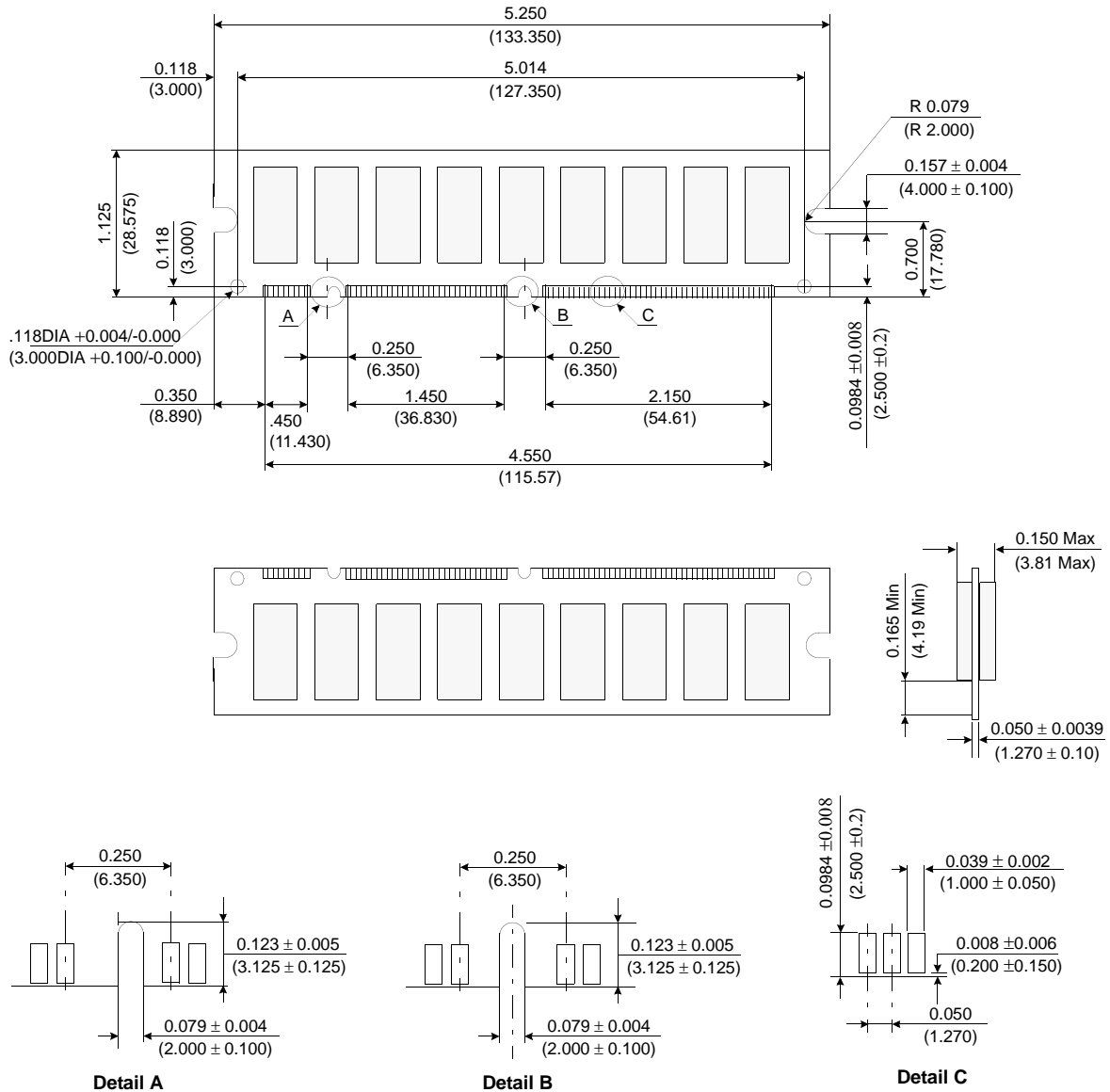

Tolerances : ± 0.005(.13) unless otherwise specified

The used device is 32Mx8 SDRAM, TSOPII  
SDRAM Part No. : K4S560832E



Rev. 1.4 May 2004