

54ABT245

Octal Bidirectional Transceiver with TRI-STATE® Outputs

General Description

The 'ABT245 contains eight non-inverting bidirectional buffers with TRI-STATE outputs and is intended for bus-oriented applications. Current sinking capability is 48 mA on both the A and B ports. The Transmit/Receive (T/R) input determines the direction of data flow through the bidirectional transceiver. Transmit (active HIGH) enables data from A ports to B ports; Receive (active LOW) enables data from B ports to A ports. The Output Enable input, when HIGH, disables both A and B ports by placing them in a High Z condition.

Features

- Bidirectional non-inverting buffers
- A and B output sink capability of 48 mA, source capability of 24 mA

- Guaranteed output skew
- Guaranteed multiple output switching specifications
- Output switching specified for both 50 pF and 250 pF loads
- Guaranteed simultaneous switching, noise level and dynamic threshold performance
- Guaranteed latching protection
- High impedance glitch-free bus loading during entire power up and power down cycle
- Non-destructive hot insertion capability
- Disable time is less than enable time to avoid bus contention
- Standard Microcircuit Drawing (SMD) 5962-9214801

Ordering Code:

Military	Package Number	Package Description
54ABT245J-QML	J20A	20-Lead Ceramic Dual-In-Line
54ABT245W-QML	W20A	20-Lead Cerpak
54ABT245E-QML	E20A	20-Lead Ceramic Leadless Chip Carrier, Type C

Logic Symbol

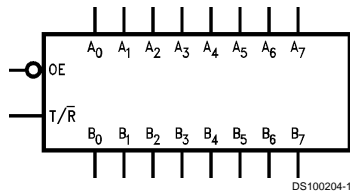

TRI-STATE® is a registered trademark of National Semiconductor Corporation.

Connection Diagrams

Pin Assignment for DIP and Flatpak.

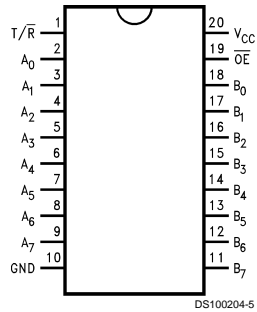

Pin Assignment for LCC

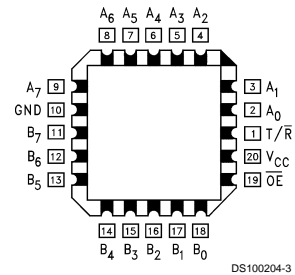

Pin Descriptions

Pin Names	Description
\overline{OE}	Output Enable Input (Active LOW)
T/\overline{R}	Transmit/Receive Input
A_0 – A_7	Side A Inputs or TRI-STATE Outputs
B_0 – B_7	Side B Inputs or TRI-STATE Outputs

Truth Table

Inputs		Output
\overline{OE}	T/\overline{R}	
L	L	Bus B Data to Bus A
L	H	Bus A Data to Bus B
H	X	High Z State

H = HIGH Voltage Level
L = LOW Voltage Level
X = Immaterial

Logic Diagram

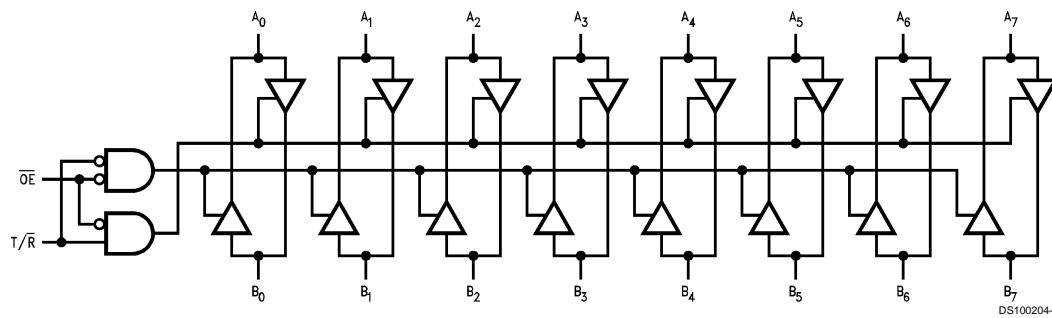

Absolute Maximum Ratings (Note 1)

If Military/Aerospace specified devices are required, please contact the National Semiconductor Sales Office/Distributors for availability and specifications.

Storage Temperature	-65°C to +150°C
Ambient Temperature under Bias	-55°C to +125°C
Junction Temperature under Bias	
Ceramic	-55°C to +175°C
V _{CC} Pin Potential to	
Ground Pin	-0.5V to +7.0V
Input Voltage (Note 2)	-0.5V to +7.0V
Input Current (Note 2)	-30 mA to +5.0 mA
Voltage Applied to Any Output	
in the Disabled or	
Power-off State	-0.5V to 5.5V
in the HIGH State	-0.5V to V _{CC}
Current Applied to Output	

in LOW State (Max)	twice the rated I _{OL} (mA)
DC Latchup Source Current	-500 mA
Over Voltage Latchup (I/O)	10V

Recommended Operating Conditions

Free Air Ambient Temperature	
Military	-55°C to +125°C
Supply Voltage	
Military	+4.5V to +5.5V
Minimum Input Edge Rate	(ΔV/Δt)
Data Input	50 mV/ns
Enable Input	20 mV/ns

Note 1: Absolute maximum ratings are values beyond which the device may be damaged or have its useful life impaired. Functional operation under these conditions is not implied.

Note 2: Either voltage limit or current limit is sufficient to protect inputs.

DC Electrical Characteristics

Symbol	Parameter		ABT245			Units	V _{CC}	Conditions
			Min	Typ	Max			
V _{IH}	Input HIGH Voltage		2.0			V		Recognized HIGH Signal
V _{IL}	Input LOW Voltage					V		Recognized LOW Signal
V _{CD}	Input Clamp Diode Voltage					V	Min	I _{IN} = -18 mA (\overline{OE} , T/ \overline{R})
V _{OH}	Output HIGH Voltage	54ABT	2.5		V	Min	I _{OH} = -3 mA (A _n , B _n)	
		54ABT	2.0		V	Min	I _{OH} = -24 mA (A _n , B _n)	
V _{OL}	Output LOW Voltage	54ABT	0.55		V	Min	I _{OL} = 48 mA (A _n , B _n)	
I _{IH}	Input HIGH Current		5		μA	Max	V _{IN} = 2.7V (\overline{OE} , T/ \overline{R}) (Note 3) V _{IN} = V _{CC} (\overline{OE} , T/ \overline{R})	
I _{BVI}	Input HIGH Current Breakdown Test		7		μA	Max	V _{IN} = 7.0V (\overline{OE} , T/ \overline{R})	
I _{BVIT}	Input HIGH Current Breakdown Test (I/O)		100		μA	Max	V _{IN} = 5.5V (A _n , B _n)	
I _{IL}	Input LOW Current		-5		μA	Max	V _{IN} = 0.5V (\overline{OE} , T/ \overline{R}) (Note 3) V _{IN} = 0.0V (\overline{OE} , T/ \overline{R})	
V _{ID}	Input Leakage Test		4.75		V	0.0	I _{ID} = 1.9 μA (\overline{OE} , T/ \overline{R}) All Other Pins Grounded	
I _{IH} + I _{OZH}	Output Leakage Current		50		μA	0 - 5.5V	V _{OUT} = 2.7V (A _n , B _n); \overline{OE} = 2.0V	
I _{IL} + I _{OZL}	Output Leakage Current		-50		μA	0 - 5.5V	V _{OUT} = 0.5V (A _n , B _n); \overline{OE} = 2.0V	
I _{OS}	Output Short-Circuit Current		-100		-275	mA	Max	V _{OUT} = 0.0V (A _n , B _n)
I _{CEX}	Output High Leakage Current		50		μA	Max	V _{OUT} = V _{CC} (A _n , B _n)	
I _{ZZ}	Bus Drainage Test		100		μA	0.0	V _{OUT} = 5.5V (A _n , B _n); All Others GND	
I _{CCH}	Power Supply Current		50		μA	Max	All Outputs HIGH	
I _{CCL}	Power Supply Current		30		mA	Max	All Outputs LOW	
I _{CCZ}	Power Supply Current		50		μA	Max	\overline{OE} = V _{CC} , T/ \overline{R} = GND or V _{CC} ; All Other GND or V _{CC}	
I _{CCT}	Additional	Outputs Enabled	2.5		mA	Max	V _I = V _{CC} - 2.1V \overline{OE} , T/ \overline{R} V _I = V _{CC} - 2.1V Data Input V _I = V _{CC} - 2.1V All Others at V _{CC} or GND.	
		Outputs TRI-STATE	2.5		mA			
		Outputs TRI-STATE	50		μA			

DC Electrical Characteristics (Continued)

Symbol	Parameter	ABT245			Units	V _{CC}	Conditions
		Min	Typ	Max			
I _{CCD}	Dynamic I _{CC} No Load (Note 3)			0.1	mA/ MHz	Max	Outputs Open $\overline{OE} = \text{GND}$, $T/\overline{R} = \text{GND}$ or V _{CC} One Bit Toggling, 50% Duty Cycle (Note 4)

Note 3: Guaranteed but not tested.

Note 4: For 8 bits toggling, I_{CCD} < 0.8 mA/MHz.

DC Electrical Characteristics

Symbol	Parameter	Min	Max	Units	V _{CC}	Conditions C _L = 50 pF, R _L = 500Ω
V _{OLP}	Quiet Output Maximum Dynamic V _{OL}		1.1	V	5.0	T _A = 25°C (Note 5)
V _{OLV}	Quiet Output Minimum Dynamic V _{OL}		-0.45	V	5.0	T _A = 25°C (Note 5)

Note 5: Max number of outputs defined as (n). n – 1 data inputs are driven 0V to 3V. One output at LOW.

AC Electrical Characteristics

Symbol	Parameter	54ABT		Units
		T _A = -55°C to +125°C V _{CC} = 4.5V–5.5V C _L = 50 pF		
		Min	Max	
t _{PLH}	Propagation Delay	1.0	4.8	ns
t _{PHL}	Data to Outputs	1.0	4.8	
t _{PZH}	Output Enable	1.0	6.7	ns
t _{PZL}	Time	2.0	7.5	
t _{PHZ}	Output Disable	1.7	7.4	ns
t _{PLZ}	Time	1.7	6.5	

Capacitance

Symbol	Parameter	Typ	Units	Conditions T _A = 25°C
C _{IN}	Input Capacitance	5.0	pF	V _{CC} = 0V (\overline{OE} , T/ \overline{R})
C _{I/O} (Note 6)	I/O Capacitance	11.0	pF	V _{CC} = 5.0V (A _n , B _n)

Note 6: C_{I/O} is measured at frequency f = 1 MHz, per MIL-STD-883B, Method 3012.

Capacitance (Continued)

t_{PLH} vs Temperature (T_A)
 $C_L = 50$ pF, 1 Output Switching

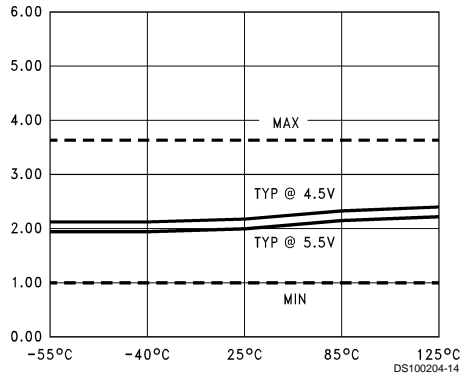

t_{PHL} vs Temperature (T_A)
 $C_L = 50$ pF, 1 Output Switching

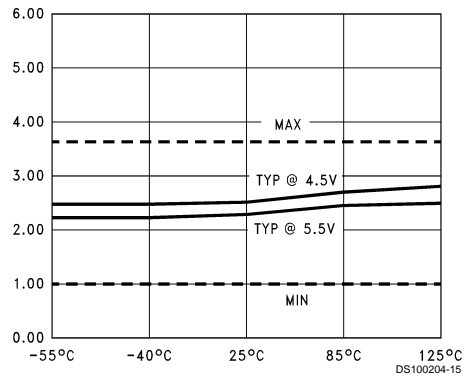

t_{PLH} vs Load Capacitance
 1 Output Switching, $T_A = 25^\circ\text{C}$

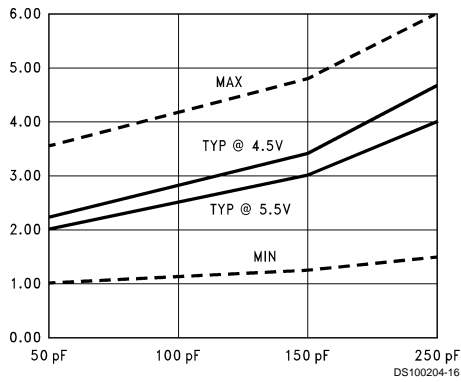

t_{PHL} vs Load Capacitance
 1 Output Switching, $T_A = 25^\circ\text{C}$

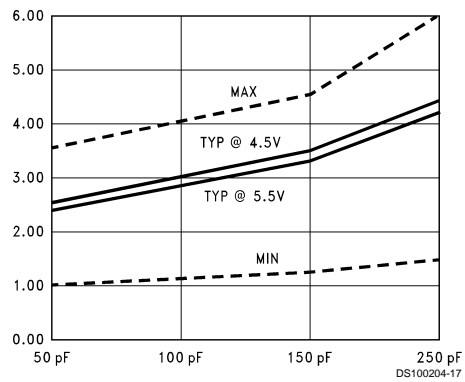

Dashed lines represent design characteristics; for specified guarantees, refer to AC Characteristics Table.

t_{PLH} vs Load Capacitance
 8 Outputs Switching, $T_A = -40^\circ\text{C}$ to $+85^\circ\text{C}$

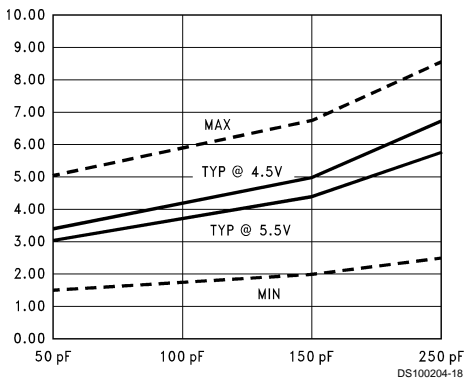

t_{PHL} vs Load Capacitance
 8 Outputs Switching, $T_A = 25^\circ\text{C}$

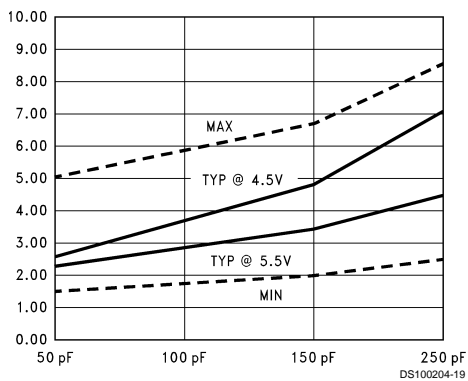

Capacitance (Continued)

t_{PZL} vs Temperature (T_A)
 $C_L = 50$ pF, 1 Output Switching

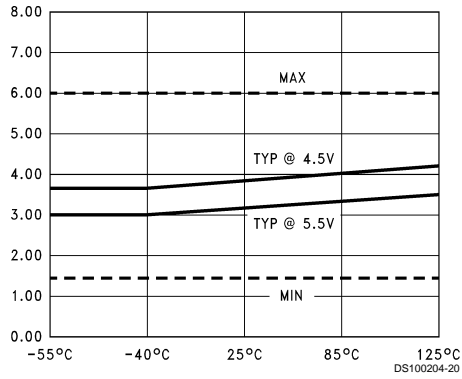

t_{PLZ} vs Temperature (T_A)
 $C_L = 50$ pF, 1 Output Switching

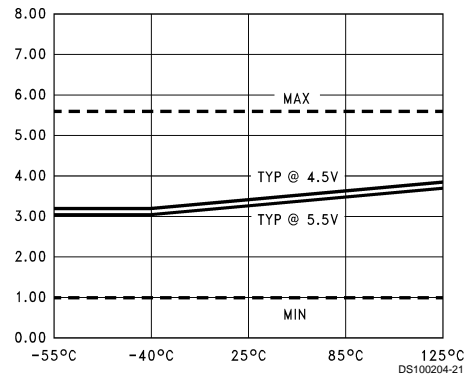

t_{PZL} vs Temperature (T_A)
 $C_L = 50$ pF, 8 Outputs Switching

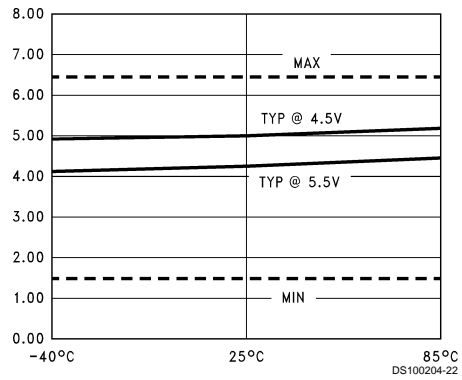

t_{PLZ} vs Temperature (T_A)
 $C_L = 50$ pF, 8 Outputs Switching

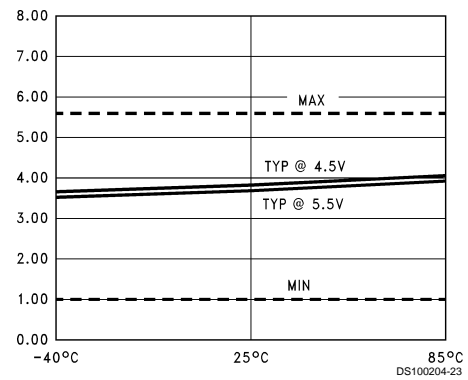

Dashed lines represent design characteristics; for specified guarantees, refer to AC Characteristics Table.

t_{PZH} vs Temperature (T_A)
 $C_L = 50$ pF, 1 Output Switching

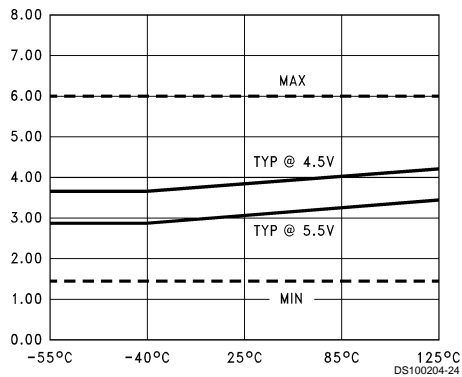

t_{PHZ} vs Temperature (T_A)
 $C_L = 50$ pF, 1 Output Switching

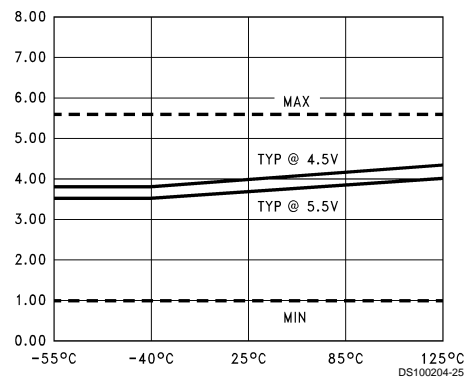

Capacitance (Continued)

t_{PZH} vs Temperature (T_A)
 $C_L = 50$ pF, 8 Outputs Switching

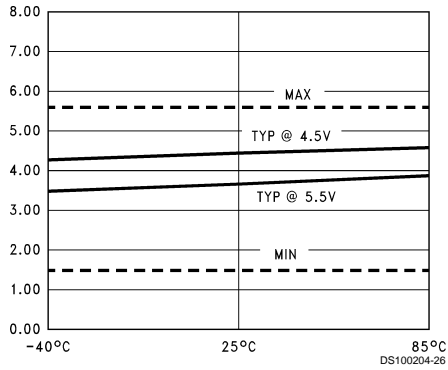

t_{PHZ} vs Temperature (T_A)
 $C_L = 50$ pF, 8 Outputs Switching

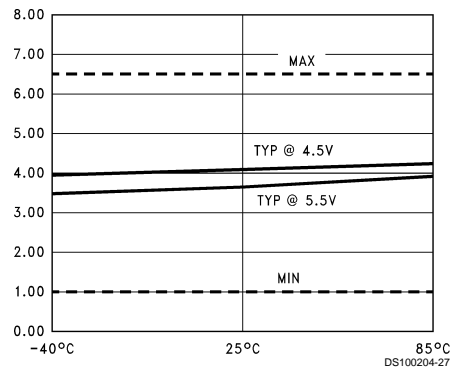

t_{PZH} vs Load Capacitance
 8 Outputs Switching, $T_A = 25^\circ\text{C}$

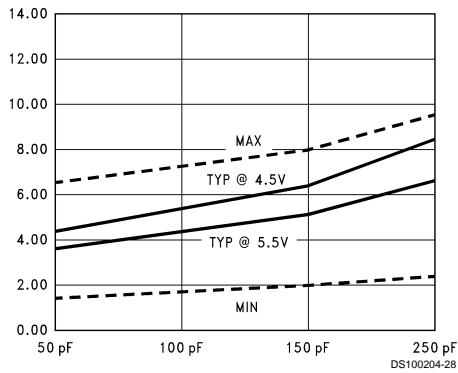

t_{PZL} vs Load Capacitance
 8 Outputs Switching, $T_A = 25^\circ\text{C}$

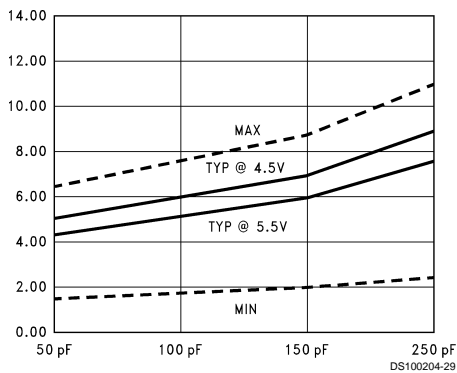

Dashed lines represent design characteristics; for specified guarantees, refer to AC Characteristics Table.

t_{PLH} and t_{PHL} vs Number Outputs Switching
 $V_{CC} = 5.0\text{V}$, $T_A = 25^\circ\text{C}$, $C_L = 50$ pF

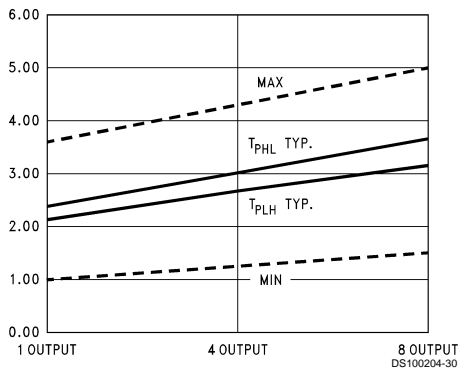

I_{CC} vs Frequency, Average, $T_A = 25^\circ\text{C}$,
 All Outputs Unloaded/Unterminated

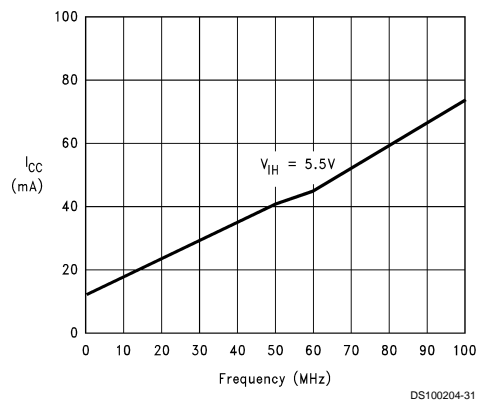

Dashed lines represent design characteristics; for specified guarantees, refer to AC Characteristics Table.

AC Loading

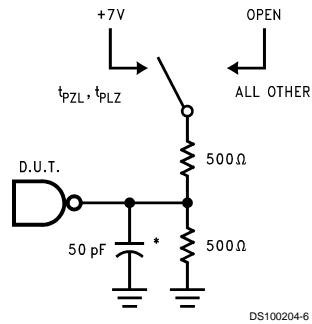

*Includes jig and probe capacitance

FIGURE 1. Standard AC Test Load

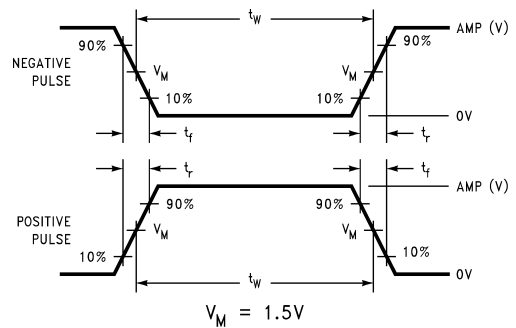

FIGURE 2. Test Input Signal Levels

Amplitude	Rep. Rate	t_w	t_r	t_f
3.0V	1 MHz	500 ns	2.5 ns	2.5 ns

FIGURE 3. Test Input Signal Requirements

AC Waveforms

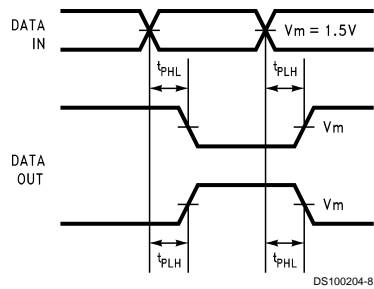

FIGURE 4. Propagation Delay Waveforms for Inverting and Non-Inverting Functions

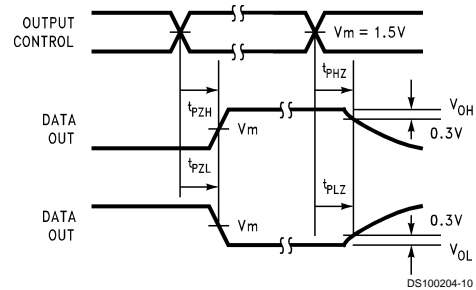
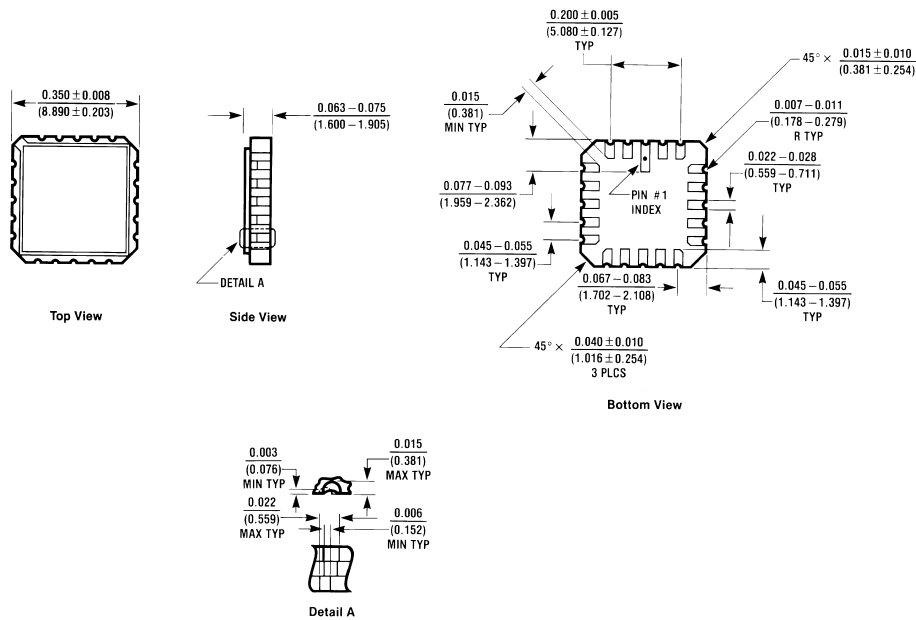

FIGURE 5. TRI-STATE Output HIGH and LOW Enable and Disable Times

Physical Dimensions inches (millimeters) unless otherwise noted



E20A (REV D)

20-Terminal Ceramic Chip Carrier (L)
NS Package Number E20A

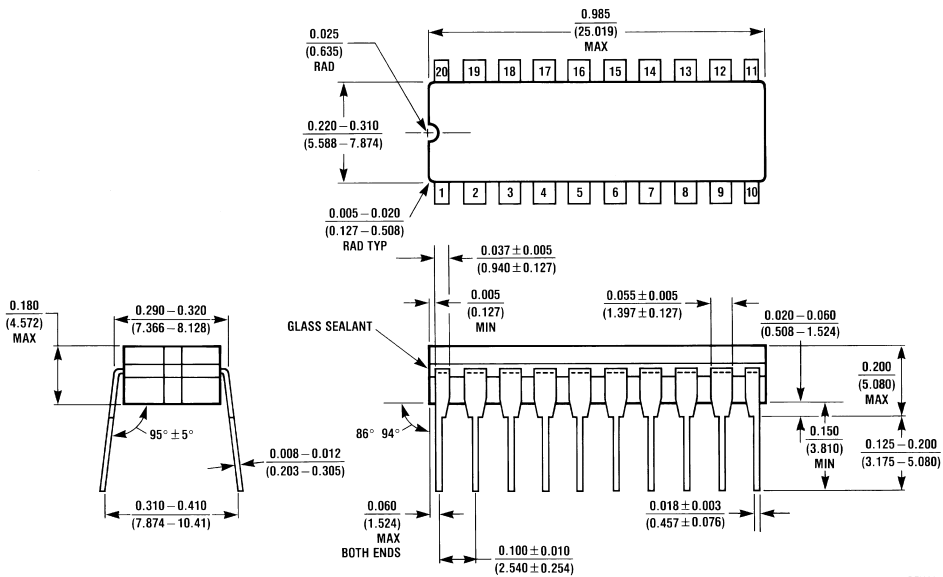

J20A (REV M)

20-Lead Ceramic Dual-In-Line Package (D)
NS Package Number J20A

Physical Dimensions inches (millimeters) unless otherwise noted (Continued)

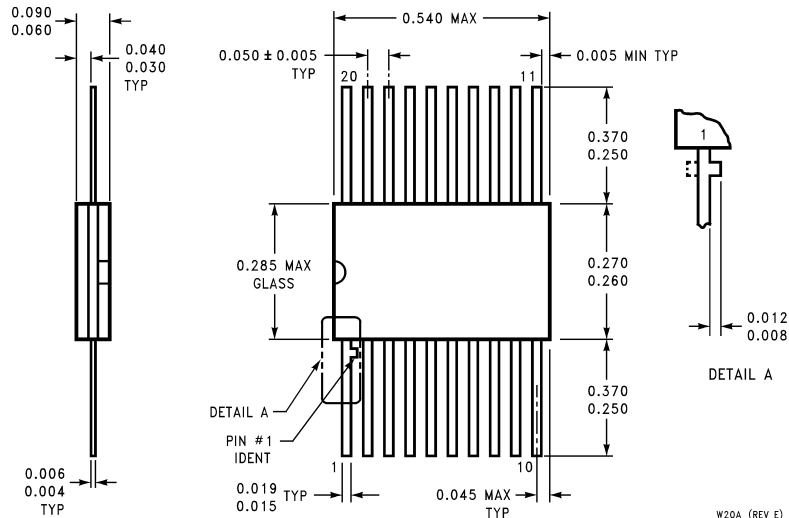

**20-Lead Ceramic Flatpak (F)
NS Package Number W20A**

W20A (REV E)

LIFE SUPPORT POLICY

NATIONAL'S PRODUCTS ARE NOT AUTHORIZED FOR USE AS CRITICAL COMPONENTS IN LIFE SUPPORT DEVICES OR SYSTEMS WITHOUT THE EXPRESS WRITTEN APPROVAL OF THE PRESIDENT OF NATIONAL SEMICONDUCTOR CORPORATION. As used herein:

1. Life support devices or systems are devices or systems which, (a) are intended for surgical implant into the body, or (b) support or sustain life, and whose failure to perform when properly used in accordance with instructions for use provided in the labeling, can be reasonably expected to result in a significant injury to the user.
2. A critical component in any component of a life support device or system whose failure to perform can be reasonably expected to cause the failure of the life support device or system, or to affect its safety or effectiveness.



National Semiconductor Corporation
Americas
Tel: 1-800-272-9959
Fax: 1-800-737-7018
Email: support@nsc.com

National Semiconductor Europe
Fax: +49 (0) 1 80-530 85 86
Email: europe.support@nsc.com
Deutsch Tel: +49 (0) 1 80-530 85 85
English Tel: +49 (0) 1 80-532 78 32
Français Tel: +49 (0) 1 80-532 93 58
Italiano Tel: +49 (0) 1 80-534 16 80

National Semiconductor Asia Pacific Customer Response Group
Tel: 65-2544466
Fax: 65-2504466
Email: sea.support@nsc.com

National Semiconductor Japan Ltd.
Tel: 81-3-5620-6175
Fax: 81-3-5620-6179

www.national.com

National does not assume any responsibility for use of any circuitry described, no circuit patent licenses are implied and National reserves the right at any time without notice to change said circuitry and specifications.