

DATA SHEET

SMS392x Series: Surface Mount General Purpose Schottky Diodes

Applications

- High volume commercial detectors, mixers, switches, and digital pulse forming systems

Features

- Tight parameter distribution
- Available as singles, pairs, and dual series pairs
- 100 percent DC tested
- Packages rated MSL1, 260 °C per JEDEC J-STD-020

NEW

Skyworks offers lead (Pb)-free, RoHS (Restriction of Hazardous Substances) compliant packaging.









Description

The SMS3922, SMS3923, and SMS3924 series of 8, 20, and 70 V rated, low-cost plastic packaged Schottky diodes are designed for general purpose use in RF applications. All diodes are fully characterized, including SPICE model parameters, and deliver tight parameter distribution, which minimizes performance variability.

Wiring configurations include singles, common cathode, series pairs, unconnected pairs, and dual series pairs.

Table 1 describes the various packages and marking of the SMS392x series.

Table 1. SMS392x Series Packaging and Marking

							
Single	Single	Single	Common Cathode	Series Pair	Unconnected Pair	Unconnected Pair	Dual Series Pair
SC-79	SOD-323	SOT-23	SOT-23	SOT-23	SOT-143	LGA	SC-88
		SMS3922-001 Marking: SA1	SMS3922-004 Marking: SA3	SMS3922-005 Marking: SA2	SMS3922-015 Marking: SA7		
SMS3922-079LF Marking: Cathode	SMS3922-011LF Marking: XA	SMS3922-001LF Marking: XA1	SMS3922-004LF Marking: XA3	SMS3922-005LF Marking: XA2	SMS3922-015LF Marking: XA7		
		SMS3923-001 Marking: SB1		SMS3923-005 Marking: SB2	SMS3923-015 Marking: SB7	SMS3923-517 Marking: B Pb-Free	
SMS3923-079LF Marking: Cathode	◆ SMS3923-011LF Marking: XB	SMS3923-001LF Marking: XB1		SMS3923-005LF Marking: XB2	SMS3923-015LF Marking: XB7		SMS3923-081LF Marking: XBQ
◆ SMS3924-079LF Marking: Cathode				SMS3924-005 Marking: SC2	SMS3924-015 Marking: SC7		
				SMS3924-005LF Marking: XC2	SMS3924-015LF Marking: XC7		
L _s = 0.7 nH	L _s = 1.5 nH	L _s = 1.5 nH	L _s = 1.5 nH	L _s = 1.5 nH	L _s = 1.4 nH	L _s = 0.6 nH	L _s = 1.8 nH
				SC-70	SC-70		
				SMS3924-075 Marking: SC2			
				SMS3924-075LF Marking: XC2			
				L _s = 1.4 nH			



LF denotes lead (Pb)-free, RoHS-compliant packaging option as an alternative to the standard Skyworks tin/lead (Sn/Pb) packaging.



Innovation to Go™
Select Linear Products (indicated by ◆) now available for purchase online.

Electrical and Mechanical Specifications

The absolute maximum ratings of the SMP1340 series are provided in Table 2. Electrical specifications are provided in Table 3. The associated SPICE model parameters are provided in Table 4.

A pinout and equivalent circuit diagram for the dual series pair Schottky diode (SMS3923-081LF) is shown in Figure 1. Typical performance characteristics of the SMS392x series are illustrated in Figures 2 to 6. Package dimensions are shown in Figures 7 to 19 (odd number), and tape and reel dimensions are provided in Figures 8 to 20 (even numbers).

Package and Handling Information

Instructions on the shipping container label regarding exposure to moisture after the container seal is broken must be followed.

Otherwise, problems related to moisture absorption may occur when the part is subjected to high temperature during solder assembly.

The SMS392x series is rated to Moisture Sensitivity Level 1 (MSL1) at 260 °C for five seconds. It can be used for lead or lead-free soldering. For additional information, refer to the Skyworks Application Note, *Solder Reflow Information*, document number 200164

Care must be taken when attaching this product, whether it is done manually or in a production solder reflow environment. Production quantities of this product are shipped in a standard tape and reel format. For packaging details, refer to the Skyworks Application Note *Discrete Devices and IC Switch/Attenuators Tape and Reel Package Orientation*, document number 200083.

Table 2. SMS392x Series Absolute Maximum Ratings

Parameter	Symbol	Minimum	Maximum	Units
Reverse voltage	V_R		Rated V_B	V
Forward current: steady state 1 ms pulse	I_F		50 1000	mA mA
Power dissipation @ 25 °C lead temperature	P_D		125	mW
Storage temperature	T_{STG}	-65	+150	°C
Operating temperature	T_A	-65	+150	°C
Junction temperature	T_J		+150	°C

Note: Exposure to maximum rating conditions for extended periods may reduce device reliability. There is no damage to device with only one parameter set at the limit and all other parameters set at or below their nominal value. Exceeding any of the limits listed here may result in permanent damage to the device.

CAUTION: Although this device is designed to be as robust as possible, Electrostatic Discharge (ESD) can damage this device. This device must be protected at all times from ESD. Static charges may easily produce potentials of several kilovolts on the human body or equipment, which can discharge without detection. Industry-standard ESD precautions should be used at all times. The SMS392x series Schottky diodes are rated Class 0 ESD Human Body Model (HBM) and Class C4 Charged Device Model (CDM) devices.

Table 3. SMS392x Series Electrical Specifications (Note 1)
($T_A = +25$ °C, Per Junction Unless Otherwise Noted)

Part Number	$V_B @ 10 \mu A$ (V, Minimum)	I_R	$C_T @ 0 V$ (pF)	$V_F @ 1 mA$ (mV)	Pair Configuration $\Delta V_F @ 1 mA$ (mV, Maximum)	V_F , Maximum
SMS3922 series	8	<100 nA @ 1 V	0.63 to 1.03	280 to 340	10	<450 mV @ 10 mA
SMS3923 series	20	<500 nA @ 15 V	0.83 to 1.23	310 to 370	10	<1000 mV @ 35 mA
SMS3924 series	70	<200 nA @ 50 V	1.43 to 1.83	490 to 550	10	<1000 mV @ 15 mA

Note 1: Performance is guaranteed only under the conditions listed in this Table.

Table 4. SPICE Model Parameters

Parameter	Units	SMS3922 Series	SMS3923 Series	SMS3924 Series
I_S	A	3E-8	5E-9	2E-11
R_S	Ω	9	10	11
N	–	1.08	1.05	1.08
T_T	sec	8E-11	8E-11	8E-11
C_{J0}	pF	0.7	0.9	1.5
M	–	0.26	0.24	0.40
E_G	eV	0.69	0.69	0.69
X_{TI}	–	2	2	2
F_C	–	0.5	0.5	0.5
B_V	V	20	46	100
I_{BV}	A	1E-5	1E-5	1E-5
V_J	V	0.595	0.640	0.840

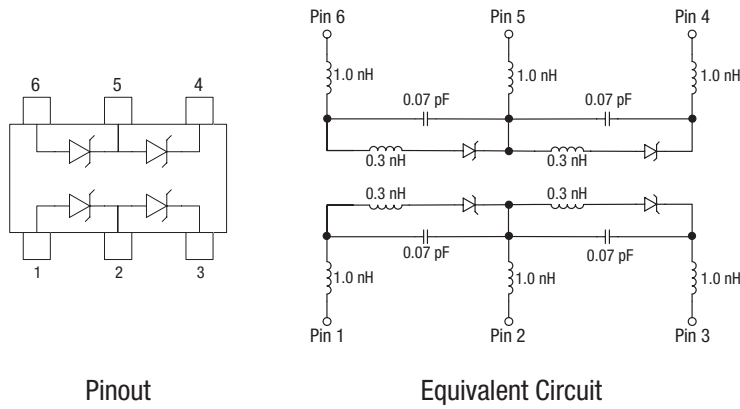

S1671

Figure 1. SMS3923-081 Dual Series Pair Pinout and Equivalent Circuit

Typical Performance Characteristics

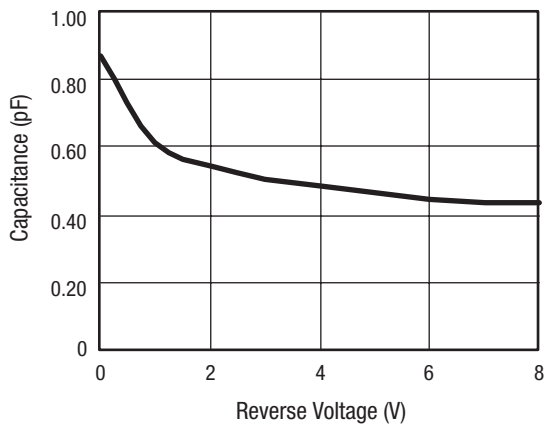

Figure 2. SMS3922 Series Total Capacitance vs Reverse Voltage

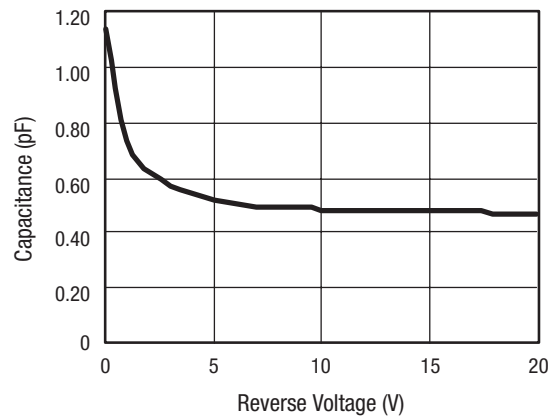

Figure 3. SMS3923 Series Total Capacitance vs Reverse Voltage

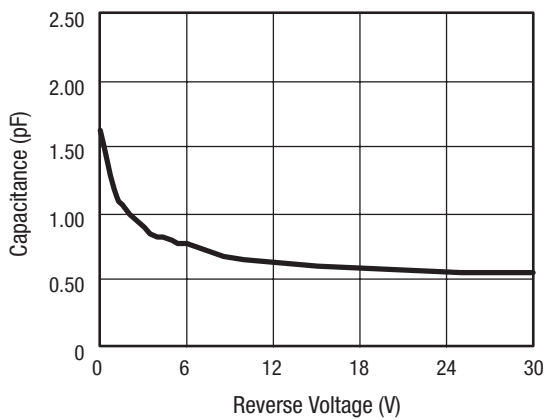

Figure 4. SMS3924 Total Capacitance vs Reverse Voltage

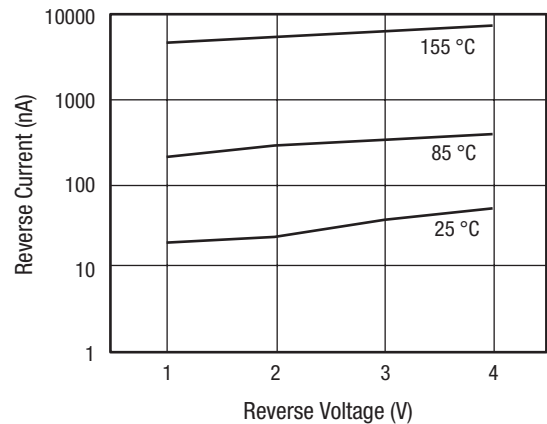

Figure 5. SMS3922 Reverse Current vs Reverse Voltage

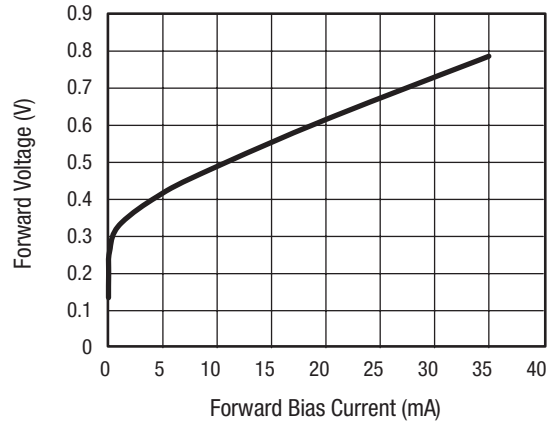
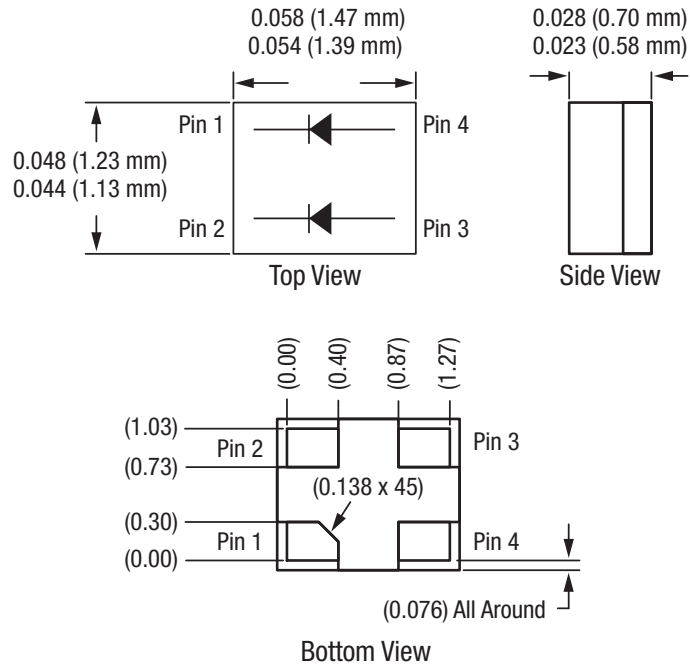

Figure 6. SMS3923-081LF Series Forward Voltage vs Forward Bias Current



Dimensions are in inches (millimeters shown in parentheses)

S1833

Figure 7. LGA (SMS3923-517) Package Dimension Drawing

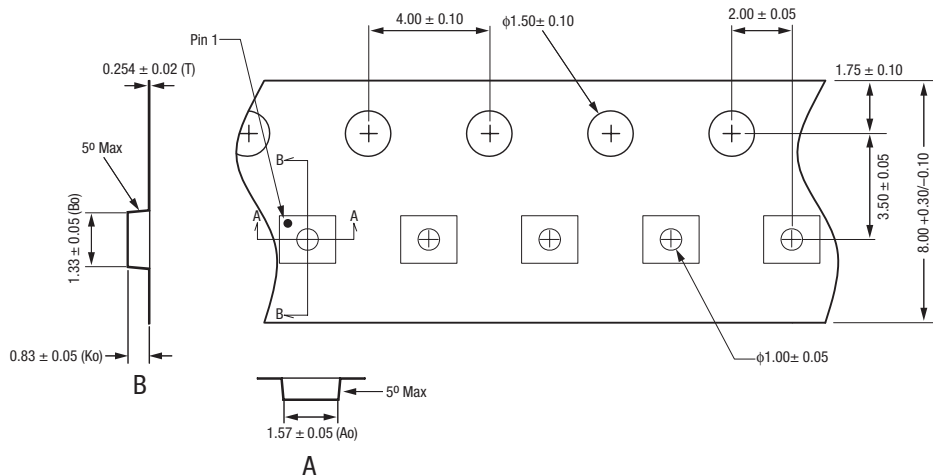

Notes:

1. Carrier tape: black conductive polycarbonate or polystyrene.
2. Cover tape material: transparent conductive PSA.
3. Cover tape size: 5.4 mm width.
4. All measurements are in millimeters.

S1682

Figure 8. LGA Tape and Reel Dimensions

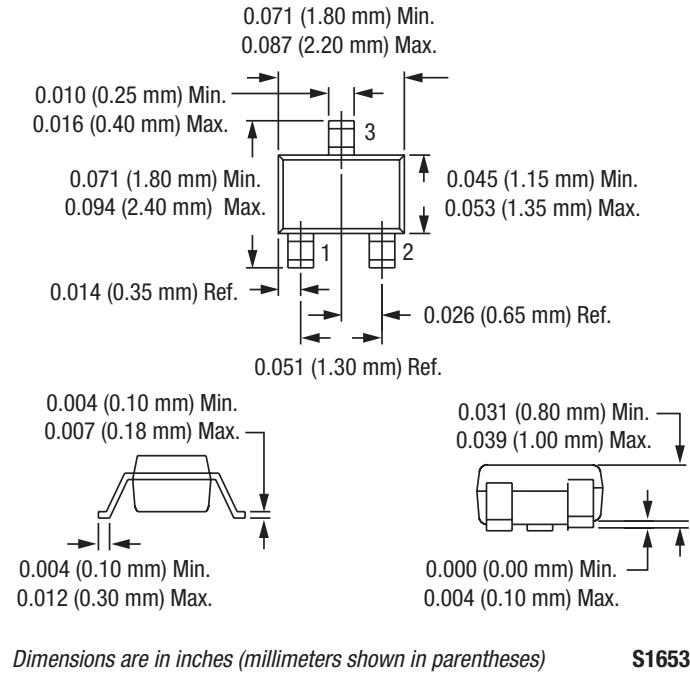

Figure 9. SC-70 Package Dimension Drawing

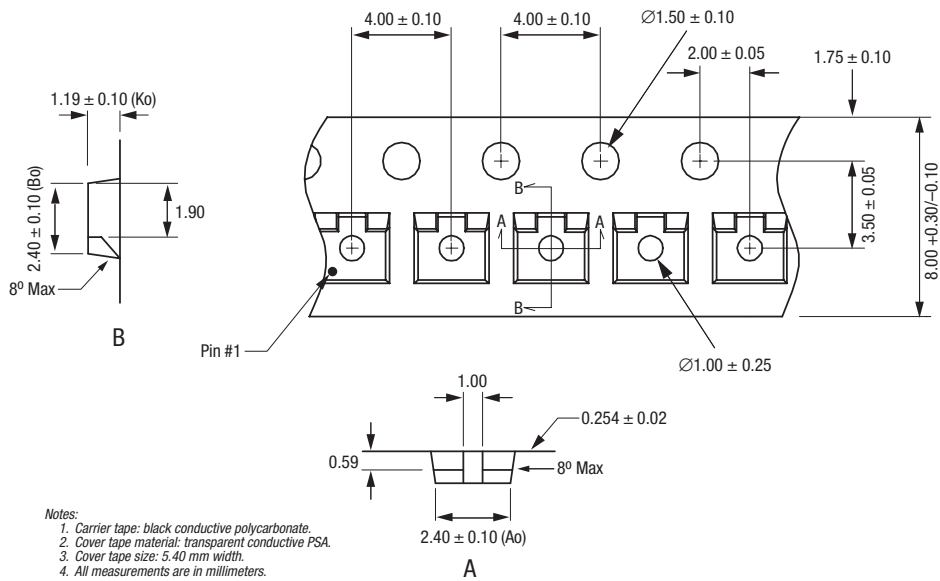
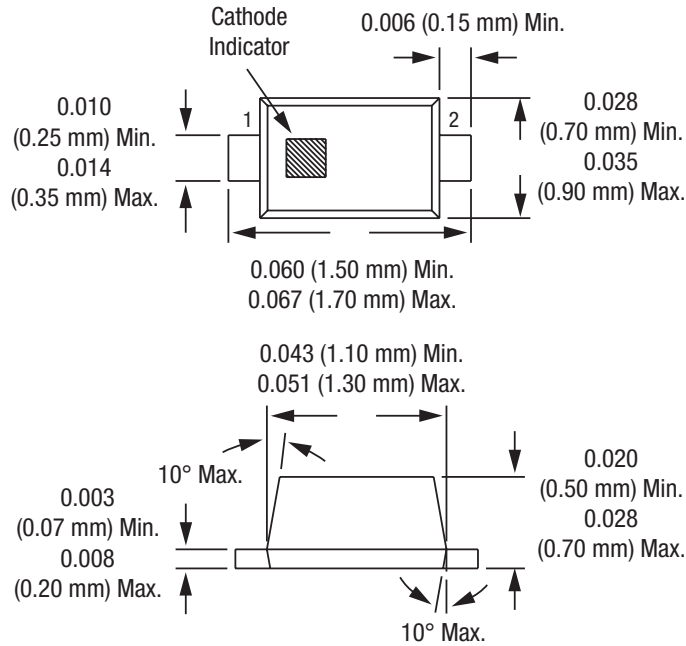
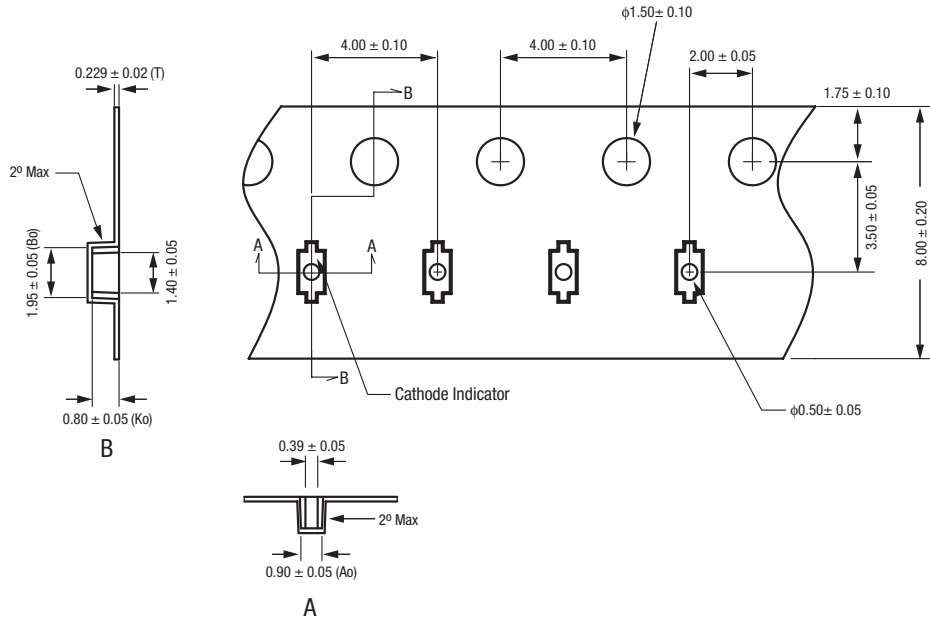

Figure 10. SC-70 Tape and Reel Dimensions



Dimensions are in inches (millimeters shown in parentheses) **S1652**

Figure 11. SC-79 Package Dimension Drawing



- Notes:
1. Carrier tape: black conductive polycarbonate or polystyrene.
 2. Cover tape material: transparent conductive PSA.
 3. Cover tape size: 5.4 mm width.
 4. All measurements are in millimeters.

S1673

Figure 12. SC-79 Tape and Reel Dimensions

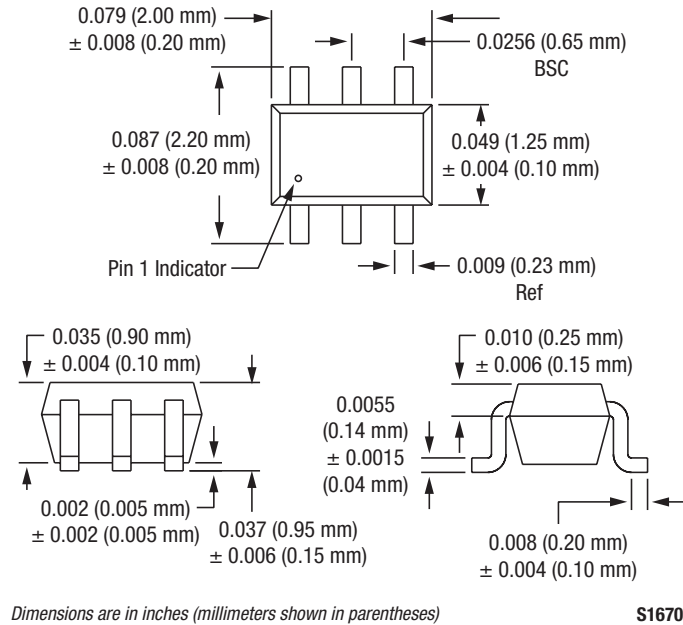

Figure 13. SC-88 Package Dimension Drawing

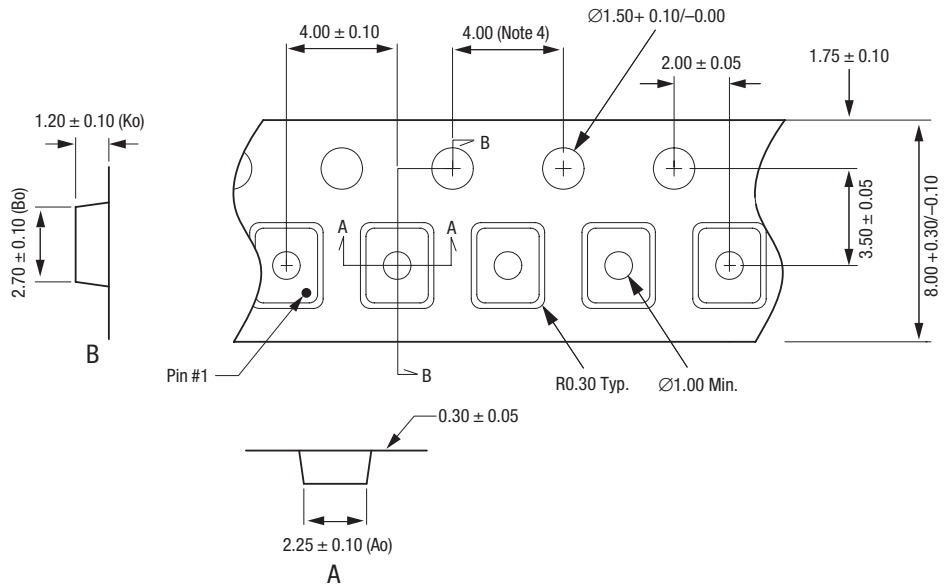
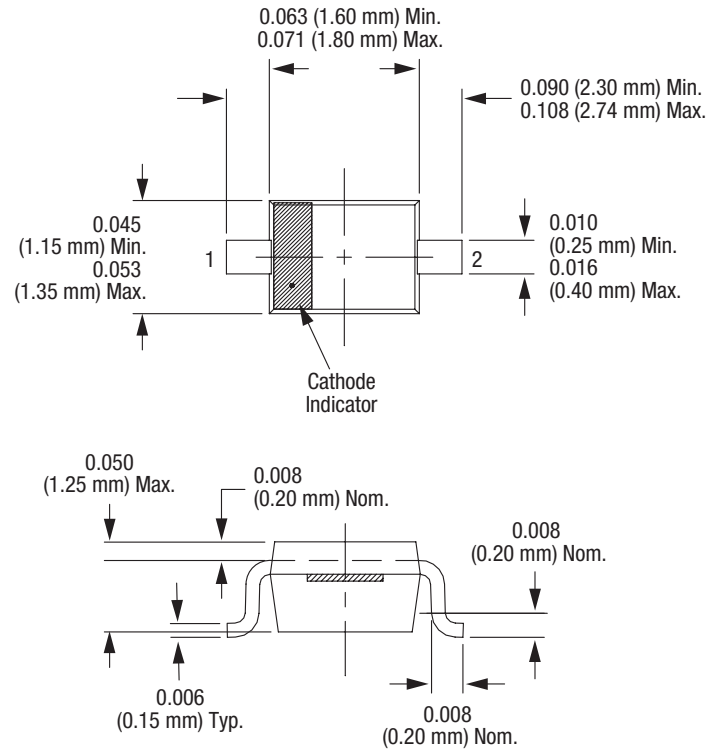

Figure 14. SC-88 Tape and Reel Dimensions



Dimensions are in inches (millimeters shown in parentheses)

S1619

Figure 15. SOD-323 Package Dimension Drawing

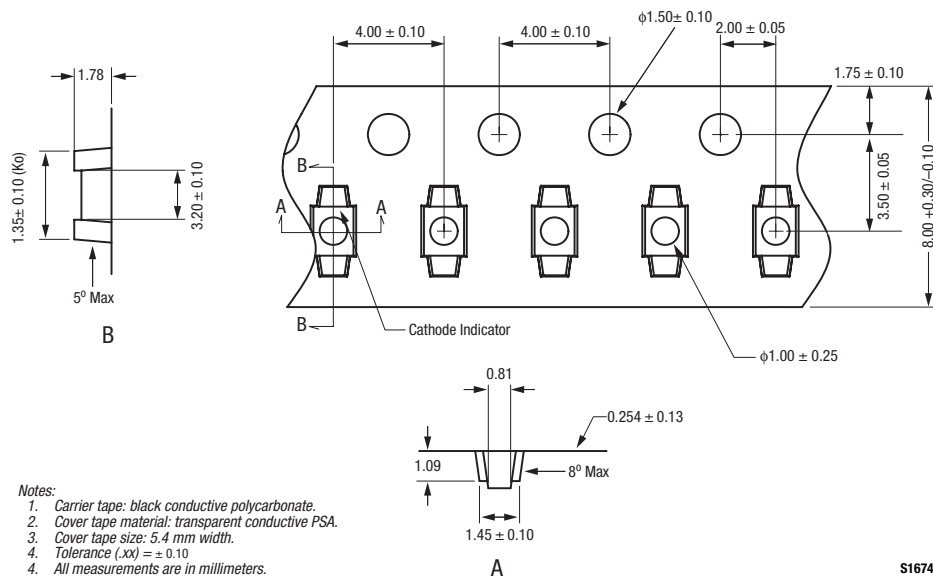

- Notes:
1. Carrier tape: black conductive polycarbonate.
 2. Cover tape material: transparent conductive PSA.
 3. Cover tape size: 5.4 mm width.
 4. Tolerance (.xx) = ± 0.10
 4. All measurements are in millimeters.

S1674

Figure 16. SOD-323 Tape and Reel Dimensions

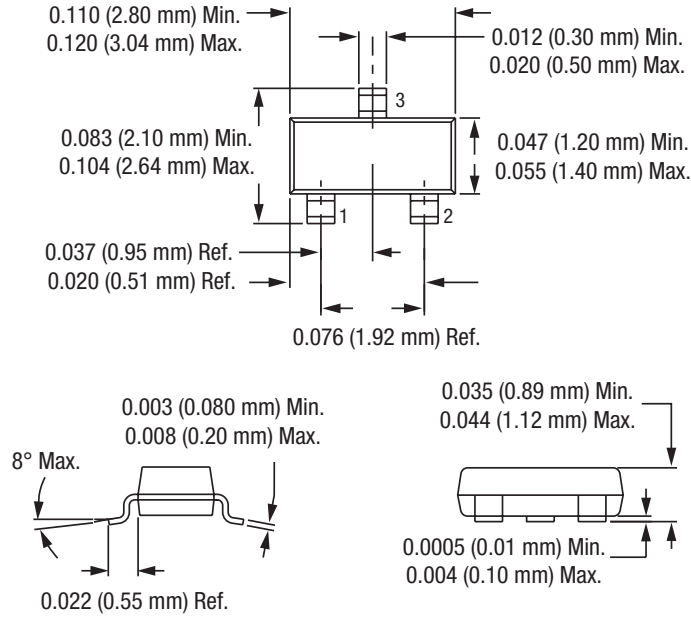

Dimensions are in inches (millimeters shown in parentheses)

S1389

Figure 17. SOT-23 Package Dimension Drawing

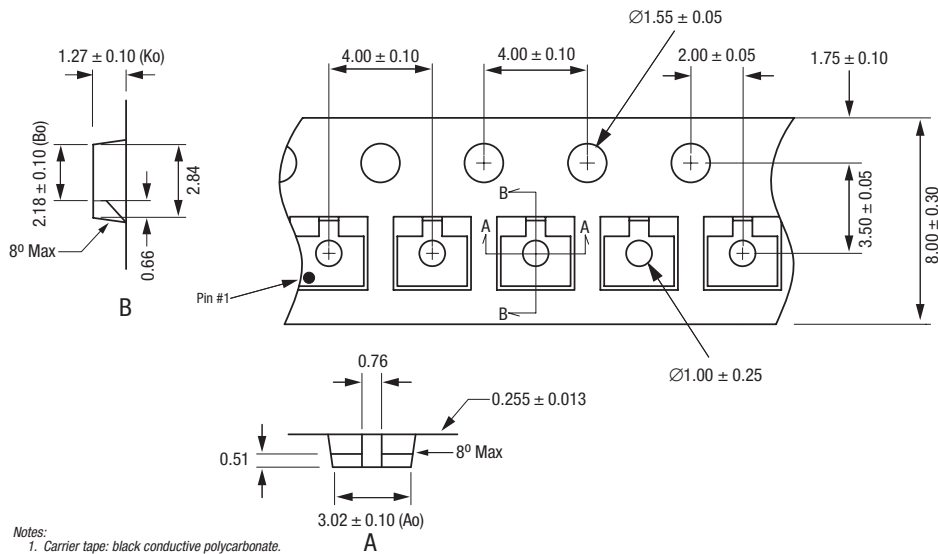

- Notes:
1. Carrier tape: black conductive polycarbonate.
 2. Cover tape material: transparent conductive PSA.
 3. Cover tape size: 5.40 mm width.
 4. Tolerance ± 0.10 mm.
 5. All measurements are in millimeters.

S1684

Figure 18. SOT-23 Tape and Reel Dimensions

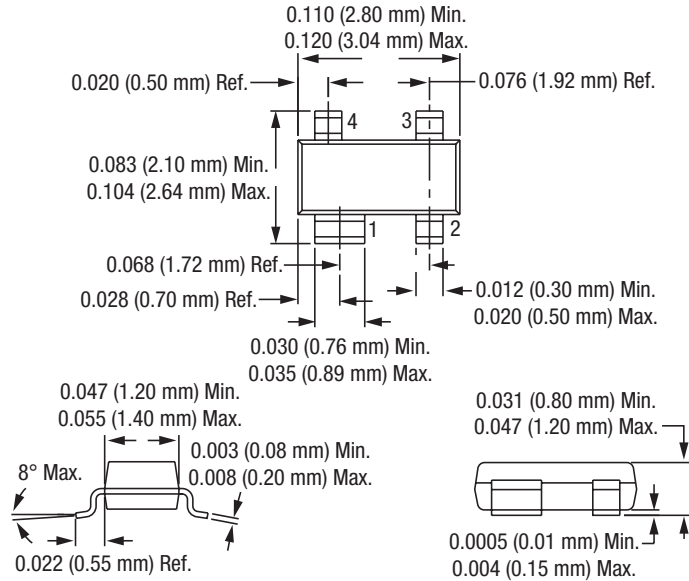

Dimensions are in inches (millimeters shown in parentheses) **S1651**

Figure 19. SOT-143 Package Dimension Drawing

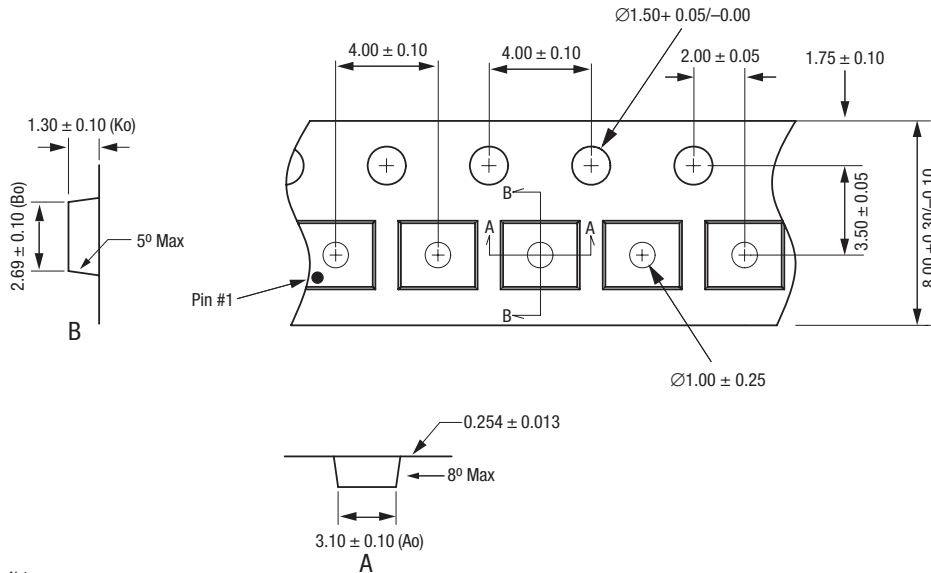

- Notes:
1. Carrier tape: black conductive polycarbonate.
 2. Cover tape material: transparent conductive PSA.
 3. Cover tape size: 5.40 mm width.
 4. Tolerance ± 0.10 mm.
 5. All measurements are in millimeters.

S1683

Figure 20. SOT-143 Tape and Reel Dimensions

Copyright © 2002-2007, 2009 Skyworks Solutions, Inc. All Rights Reserved.

Information in this document is provided in connection with Skyworks Solutions, Inc. ("Skyworks") products or services. These materials, including the information contained herein, are provided by Skyworks as a service to its customers and may be used for informational purposes only by the customer. Skyworks assumes no responsibility for errors or omissions in these materials or the information contained herein. Skyworks may change its documentation, products, services, specifications or product descriptions at any time, without notice. Skyworks makes no commitment to update the materials or information and shall have no responsibility whatsoever for conflicts, incompatibilities, or other difficulties arising from any future changes.

No license, whether express, implied, by estoppel or otherwise, is granted to any intellectual property rights by this document. Skyworks assumes no liability for any materials, products or information provided hereunder, including the sale, distribution, reproduction or use of Skyworks products, information or materials, except as may be provided in Skyworks Terms and Conditions of Sale.

THE MATERIALS, PRODUCTS AND INFORMATION ARE PROVIDED "AS IS" WITHOUT WARRANTY OF ANY KIND, WHETHER EXPRESS, IMPLIED, STATUTORY, OR OTHERWISE, INCLUDING FITNESS FOR A PARTICULAR PURPOSE OR USE, MERCHANTABILITY, PERFORMANCE, QUALITY OR NON-INFRINGEMENT OF ANY INTELLECTUAL PROPERTY RIGHT; ALL SUCH WARRANTIES ARE HEREBY EXPRESSLY DISCLAIMED. SKYWORKS DOES NOT WARRANT THE ACCURACY OR COMPLETENESS OF THE INFORMATION, TEXT, GRAPHICS OR OTHER ITEMS CONTAINED WITHIN THESE MATERIALS. SKYWORKS SHALL NOT BE LIABLE FOR ANY DAMAGES, INCLUDING BUT NOT LIMITED TO ANY SPECIAL, INDIRECT, INCIDENTAL, STATUTORY, OR CONSEQUENTIAL DAMAGES, INCLUDING WITHOUT LIMITATION, LOST REVENUES OR LOST PROFITS THAT MAY RESULT FROM THE USE OF THE MATERIALS OR INFORMATION, WHETHER OR NOT THE RECIPIENT OF MATERIALS HAS BEEN ADVISED OF THE POSSIBILITY OF SUCH DAMAGE.

Skyworks products are not intended for use in medical, lifesaving or life-sustaining applications, or other equipment in which the failure of the Skyworks products could lead to personal injury, death, physical or environmental damage. Skyworks customers using or selling Skyworks products for use in such applications do so at their own risk and agree to fully indemnify Skyworks for any damages resulting from such improper use or sale.

Customers are responsible for their products and applications using Skyworks products, which may deviate from published specifications as a result of design defects, errors, or operation of products outside of published parameters or design specifications. Customers should include design and operating safeguards to minimize these and other risks. Skyworks assumes no liability for applications assistance, customer product design, or damage to any equipment resulting from the use of Skyworks products outside of stated published specifications or parameters.

Skyworks, the Skyworks symbol, and "Breakthrough Simplicity" are trademarks or registered trademarks of Skyworks Solutions, Inc., in the United States and other countries. Third-party brands and names are for identification purposes only, and are the property of their respective owners. Additional information, including relevant terms and conditions, posted at www.skyworksinc.com, are incorporated by reference.