

NPe405H

Data Sheet

PowerNP NPe405H Embedded Processor

FEATURES

- PowerNP™ technology using an AMCC PowerPC® 405 32-bit RISC processor core operating up to 266 MHz
- PC-133 synchronous DRAM (SDRAM) interface
 - 32-bit interface for non-ECC applications
 - 40-bit interface serves 32 bits of data plus 8 check bits for ECC applications
- External bus for peripheral devices
 - Flash and ROM interface
 - Direct support for 8-, or 16-, or 32-bit SRAM and external peripherals
 - Up to 8 devices
 - External mastering supported
- DMA support for external peripherals, internal UARTs and memory
 - Scatter-gather chaining supported
 - Four channels
- PCI Revision 2.2 compliant interface (32-bit, up to 66MHz)
 - Asynchronous PCI bus interface
 - Internal PCI bus arbiter which can be disabled for use with an external arbiter
- Four 10/100 Ethernet MACs supporting up to four external PHYs via MII, RMII, or SMII interfaces
- HDLC interface with 32 channels through two ports at up to 4.096 Mbps each or 8.192 Mbps for a single port
- HDLC interface with 8 channels through 8 ports at 2.048 Mbps maximum
- Programmable interrupt controller
 - Seven external and 49 internal
 - Edge triggered or level-sensitive
 - Positive or negative active
 - Non-critical or critical interrupt to processor core
- Programmable critical interrupt priority ordering
- Programmable critical interrupt vector
- Programmable timers
- Two serial ports (16550 compatible UART)
- One IIC interface
- General Purpose I/O (GPIO) available
- Supports JTAG for board level testing
- Internal processor local bus (PLB) runs at SDRAM interface frequency
- Supports PowerPC processor boot from PCI memory
- User accessible performance counters

DESCRIPTION

Designed specifically to address embedded applications, the NPe405H provides a high-performance, low-power solution that interfaces to a wide range of peripherals by incorporating on-chip power management features and lower power dissipation requirements.

This chip contains a high-performance RISC processor core, SDRAM controller, PCI bus bridge, Ethernet EMACs, HDLC controllers, external bus controller for ROM, Flash, and peripherals, DMA with scatter-gather support, serial ports, IIC interface, and general purpose I/O.

Technology: CMOS SA-12E 0.25 μm (0.18 μm L_{eff})

Package: 35mm, 580-ball enhanced plastic ball grid array (E-PBGA)

Power (typical): 2.3W at 133MHz, 2.9W at 200MHz, 3.4W at 266MHz

TABLE OF CONTENTS

FEATURES 1

DESCRIPTION 1

ORDERING, PVR, AND JTAG INFORMATION 5

 AMCC Part Number Key 5

NPE405H EMBEDDED CONTROLLER FUNCTIONAL BLOCK DIAGRAM 6

ADDRESS MAP SUPPORT 7

SYSTEM ADDRESS MAP 7

DCR ADDRESS MAP 8

PLB TO PCI BRIDGE 9

SDRAM MEMORY CONTROLLER 10

EXTERNAL BUS CONTROLLER (EBC) 10

DMA CONTROLLER 11

SERIAL INTERFACE 11

IIC BUS INTERFACE 11

IIC EEPROM CONTROLLER 11

HDLCEX INTERFACE 12

HDLCMP INTERFACE 12

GENERAL PURPOSE IO (GPIO) CONTROLLER 12

UNIVERSAL INTERRUPT CONTROLLER (UIC) 12

10/100 MBPS ETHERNET MAC 13

JTAG 13

PERFORMANCE COUNTERS 13

35 MM, 580-BALL E-PBGA PACKAGE 14

SIGNAL LISTS 15

SIGNALS LISTED ALPHABETICALLY 15

SIGNALS LISTED BY BALL ASSIGNMENT 32

SIGNAL DESCRIPTION 41

PIN SUMMARY 41

 Multiplexed Pins 41

 Multipurpose Pins 41

 Initialization Strapping 41

 Pull-up and Pull-down Resistors 42

 Unused I/Os 42

 External Peripheral Bus Control Signals 42

SIGNAL FUNCTIONAL DESCRIPTION 43

ABSOLUTE MAXIMUM RATINGS 52

PACKAGE THERMAL SPECIFICATIONS 52

RECOMMENDED DC OPERATING CONDITIONS 53

5 V-TOLERANT I/O INPUT CURRENT 54

INPUT CAPACITANCE 54

DC ELECTRICAL CHARACTERISTICS 55

TEST CONDITIONS 55

CLOCKING SPECIFICATIONS 56

CLOCKING WAVEFORM 56

SPREAD SPECTRUM CLOCKING 57

PERIPHERAL INTERFACE CLOCK TIMINGS 58

INPUT SETUP AND HOLD WAVEFORM 59

OUTPUT DELAY AND FLOAT TIMING WAVEFORM 59

I/O SPECIFICATIONS—ALL 60

I/O SPECIFICATIONS(A)—133 AND 200 MHZ 62

I/O SPECIFICATIONS(A)—266 MHZ 65

INITIALIZATION 68

 Strapping 68

STRAPPING PIN ASSIGNMENTS 68

 EEPROM 68

DOCUMENT REVISION HISTORY 69

LIST OF FIGURES

Figure 1. NPe405H Embedded Controller Functional Block Diagram 6
 Figure 2. 35mm, 580-Ball E-PBGA Package 14
 Figure 3. 5V-Tolerant I/O Input Current 54
 Figure 4. Clocking Waveform 56
 Figure 5. Input Setup and Hold Waveform 59
 Figure 6. Output Delay and Float Timing Waveform 59

LIST OF TABLES

Table 1. System Address Map 4GB Total System Memory 7
 Table 2. DCR Address Map 4KB Device Configuration Register 8
 Table 3. Signals Listed Alphabetically 15
 Table 4. Signals Listed by Ball Assignment 32
 Table 5. Pin Summary 41
 Table 6. Signal Functional Description 43
 Table 7. Absolute Maximum Ratings 52
 Table 8. Package Thermal Specifications 52
 Table 9. Recommended DC Operating Conditions 53
 Table 10. Input Capacitance 54
 Table 11. DC Electrical Characteristics 55
 Table 12. Clocking Specifications 56
 Table 13. Peripheral Interface Clock Timings 58
 Table 14. I/O Specifications—All 60
 Table 15. I/O Specifications—133 and 200MHz 62
 Table 16. I/O Specifications—266MHz 65
 Table 17. Strapping Pin Assignments 68

ORDERING, PVR, AND JTAG INFORMATION

Product Name	Order Part Number ¹	Processor Frequency	Package	Rev Level	PVR Value	JTAG ID
NPe405H	NPe405H-3JA200C	200MHz	35mm, 580 E-PBGA	A	0x41410140	0x04267049
NPe405H	NPe405H-3JA200CZ	200MHz	35mm, 580 E-PBGA	A	0x41410140	0x04267049
NPe405H	NPe405H-3JA266C	266MHz	35mm, 580 E-PBGA	A	0x41410140	0x04267049
NPe405H	NPe405H-3JA266CZ	266MHz	35mm, 580 E-PBGA	A	0x41410140	0x04267049
NPe405H	NPe405H-3BA200C	200MHz	35mm, 580 E-PBGA	A	0x41410140	0x04267049
NPe405H	NPe405H-3BA200CZ	200MHz	35mm, 580 E-PBGA	A	0x41410140	0x04267049
NPe405H	NPe405H-3BA266C	266MHz	35mm, 580 E-PBGA	A	0x41410140	0x04267049
NPe405H	NPe405H-3BA266CZ	266MHz	35mm, 580 E-PBGA	A	0x41410140	0x04267049

1. Z at the end of the Order Part Number indicates a tape and reel shipping package. Otherwise, the chips are shipped in a tray. Package type B contains lead; package type J is lead-free.

This section provides the part numbering nomenclature for the NPe405H. For availability, contact your local AMCC sales office.

The part number contains a part modifier. This modifier provides for identification of future enhancements (for example, higher performance).

Each part number also contains a revision code. This refers to the die mask revision number and is specified in the part numbering scheme for identification purposes only.

The PVR (Processor Version Register) is software accessible and contains additional information about the revision level of the part. Refer to the NPe405H User’s Manual for details on the register content.

AMCC Part Number Key

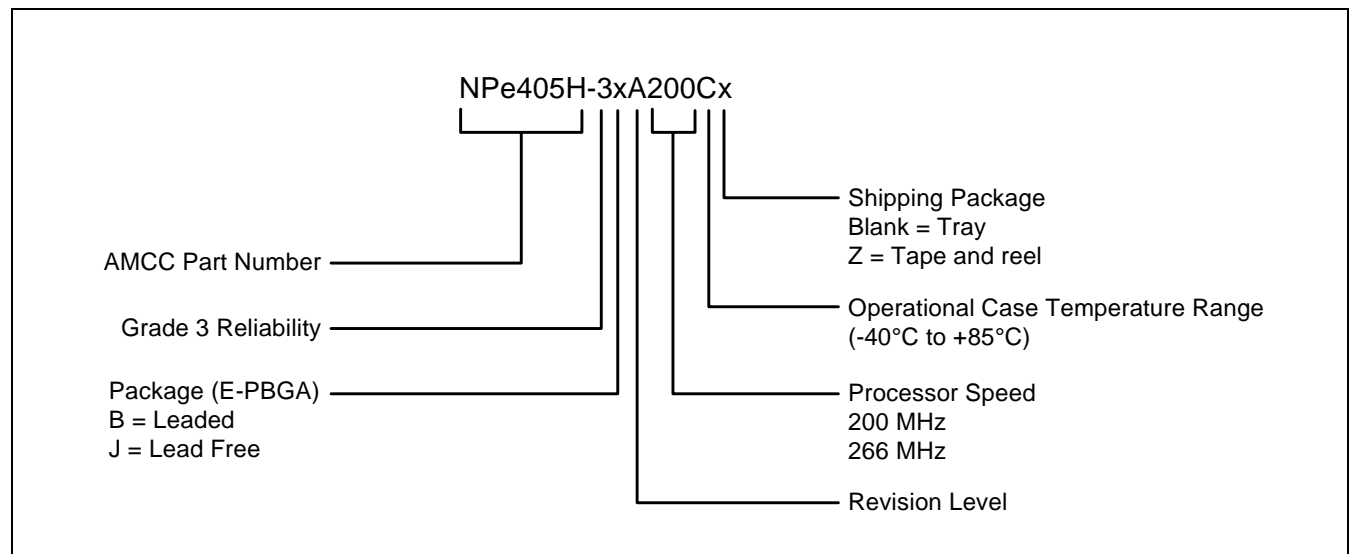

NPE405H EMBEDDED CONTROLLER FUNCTIONAL BLOCK DIAGRAM

Figure 1. NPe405H Embedded Controller Functional Block Diagram

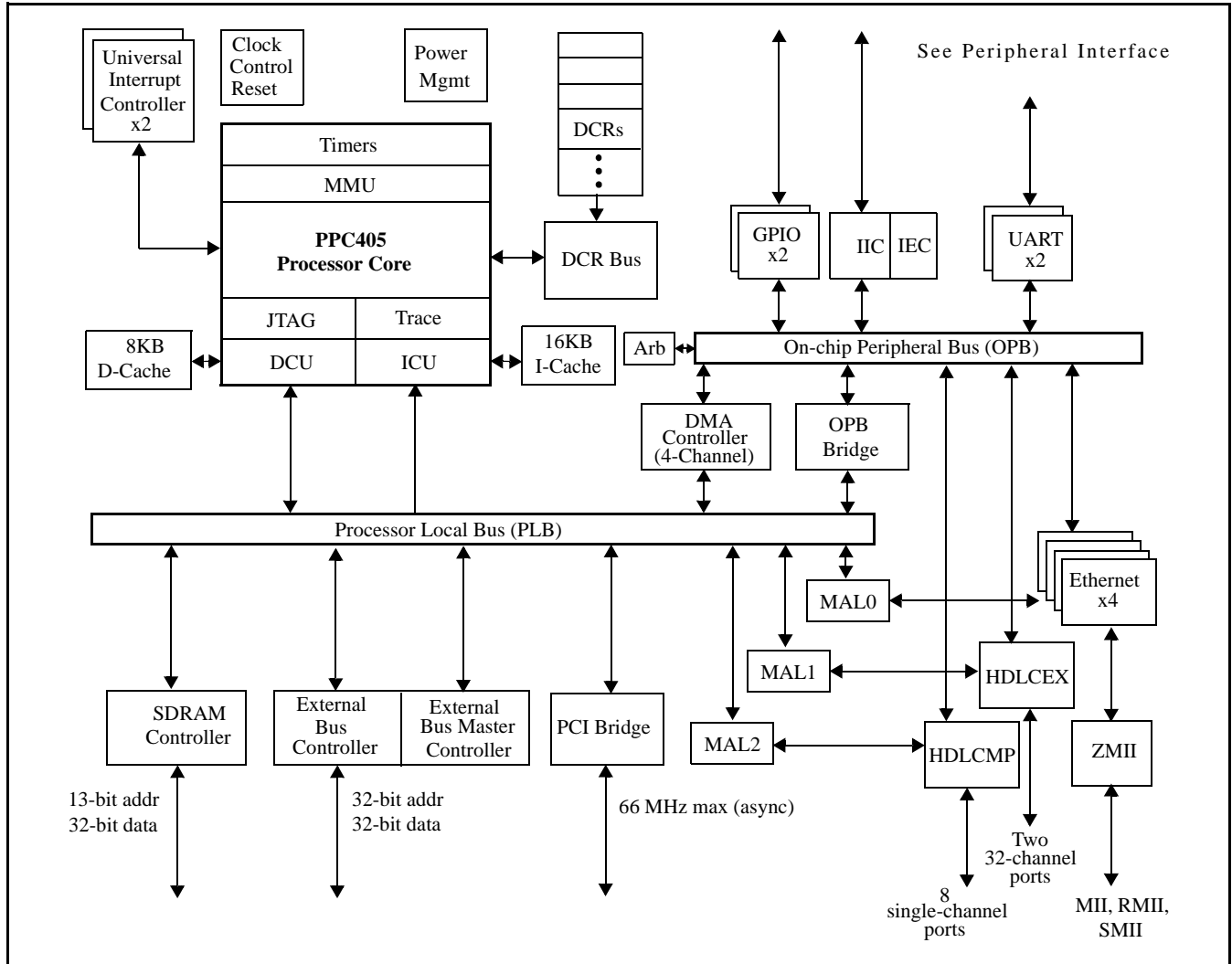

The NPe405H is designed using the IBM Microelectronics Blue Logic™ methodology in which major functional blocks are integrated to create an application-specific ASIC product. This approach provides a consistent way to generate complex ASICs using IBM CoreConnect™ Bus Architecture.

ADDRESS MAP SUPPORT

The NPe405H incorporates two separate address maps. The first is a fixed processor address map that serves the PowerPC family of processors. This address map defines the possible contents of various address regions which the processor can access. The second address map is for Device Configuration Registers (DCRs). The DCRs are accessed by software running on the NPe405H processor through the use of **mtdcr** and **mfdcr** commands.

SYSTEM ADDRESS MAP

Table 1. System Address Map 4GB Total System Memory

Function	Subfunction	Start Address	End Address	Size
General use	SDRAM, External peripherals, and PCI memory Note: Any of the address ranges listed at right may be use for any of the above functions.	0x00000000	0xE7FFFFFF	3712MB
		0xE8010000	0xE87FFFFFF	8MB
		0xEC000000	0xEEBFFFFFF	44MB
		0xEEE00000	0xEF3FFFFFF	6MB
		0xEF500000	0xEF5FFFFFF	1MB
Boot-up	External peripheral bus boot ¹	0xFFE00000	0xFFFFFFFF	2MB
	PCI boot ²	0xFFFE0000	0xFFFFFFFF	128KB
PCI	PCI I/O	0xE8000000	0xE800FFFF	64KB
	PCI I/O	0xE8800000	0xEBFFFFFF	56MB
	Configuration registers	0xEEC00000	0xEEC00007	8B
	Interrupt Acknowledge and special cycle	0xEED00000	0xEED00003	4B
	Local configuration registers	0xEF400000	0xEF40003F	64B
Internal peripherals	UART0	0xEF600300	0xEF600307	8B
	UART1	0xEF600400	0xEF600407	8B
	IIC0	0xEF600500	0xEF60051F	32B
	OPB arbiter	0xEF600600	0xEF60063F	64B
	GPIO0 controller registers	0xEF600700	0xEF60077F	128B
	GPIO1 controller registers	0xEF600780	0xEF6007FF	128B
	Ethernet MAC 0 registers	0xEF600800	0xEF6008FF	256B
	Ethernet MAC 1 registers	0xEF600900	0xEF6009FF	256B
	Ethernet MAC 2 registers	0xEF600A00	0xEF600AFF	256B
	Ethernet MAC 3 registers	0xEF600B00	0xEF600BFF	256B
	ZMII control registers	0xEF600C10	0xEF600C1F	16B
	HDLCEX	0xEF610000	0xEF61FFFF	64KB
	HDLCMP	0xEF620000	0xEF62FFFF	64KB

Notes:

1. When external peripheral bus boot is selected, peripheral bank 0 is automatically configured at reset to the address range listed above.
2. If PCI boot is selected, a PLB-to-PCI mapping is automatically configured at reset to the address range listed above.
3. After the boot process, software may reassign the boot memory regions for other uses.
4. All address ranges not listed above are reserved.

DCR ADDRESS MAP

Table 2. DCR Address Map 4KB Device Configuration Register

Function	Start	End	Size
DCR address space ¹	0x000	0x3FF	1KW (4KB) ¹
Reserved	0x000	0x00F	16W
Memory controller registers	0x010	0x011	2W
External bus controller registers	0x012	0x013	2W
Reserved	0x014	0x07F	108W
PLB registers	0x080	0x08F	16W
Performance counters	0x090	0x091	2W
Reserved	0x092	0x09F	14W
OPB bridge-out registers	0x0A0	0x0A7	8W
Reserved	0x0A8	0x0AF	8W
Clock, control and reset	0x0B0	0x0B7	8W
Power management	0x0B8	0x0BF	8W
Interrupt controller 0	0x0C0	0x0CF	16W
Interrupt controller 1	0x0D0	0x0DF	16W
Reserved	0x0E0	0x0EF	16W
Miscellaneous	0x0F0	0x0FF	16W
DMA controller registers	0x100	0x13F	64W
Reserved	0x140	0x17F	64W
MAL0 registers (Ethernet)	0x180	0x1FF	128W
MAL1 registers (HDLCEX)	0x200	0x27F	128W
MAL2 registers (HDLCMP)	0x280	0x2FF	128W
Reserved	0x300	0x3FF	256W

Notes:

1. DCR address space is addressable with up to 10 bits (1024 or 1K unique addresses). Each unique address represents a single 32-bit (word) register, or 1 kiloword (KW) (which equals 4 KB).

PLB TO PCI BRIDGE

The PLB to PCI bridge provides a mechanism for connecting PCI devices to the processor, peripherals, and memory. This interface is PCI Specification rev 2.2 compliant.

Features include:

- Internal PCI bus arbiter for up to six external devices at PCI bus speeds up to 66MHz. Internal arbiter use is optional and can be disabled for systems which employ an external arbiter.
- PCI bus frequency up to 66MHz
 - Asynchronous operation from 1/8 PLB frequency to 66MHz maximum
- 32-bit PCI Address/Data Bus
- Power Management:
 - PCI Bus Power Management v1.1 compliant
- Buffering between PLB and PCI:
 - PCI Target 64-byte write post buffer
 - PCI Target 96-byte read prefetch buffer
 - PLB Slave 32-byte write post buffer
 - PLB Slave 64-byte read prefetch buffer
- Error tracking/status
- Supports PCI Target side configuration
- Supports processor access to all PCI address spaces:
 - Single-byte PCI I/O reads and writes
 - PCI memory single-beat and prefetch-burst reads and single-beat writes
 - Single-byte PCI configuration reads and writes (type 0 and type 1)
 - PCI interrupt acknowledge
 - PCI special cycle
- Supports PCI target access to all PLB address spaces
- Supports PowerPC processor boot from PCI memory

SDRAM MEMORY CONTROLLER

The NPe405H Memory Controller provides a low latency access path to SDRAM memory. The memory controller supports four logical banks. Up to 256MB per bank are supported, for a maximum of 1 GB total. Memory access and refresh timing, address and bank sizes, and memory addressing modes are programmable.

Features include:

- 11x8 to 13x11 row-column address modes (2- and 4-bank devices supported)
- Memory bus operates at same frequency as PLB
- 32-bit memory interface support
- Programmable address range for each bank of memory
 - 4GB address space
- Industry standard 168-pin DIMMS are supported (some configurations)
- 200 MHz NPe405H supports up to 100 MHz memory with PC100 support
- 266 MHz NPe405H supports up to 133 MHz memory with PC133 support
- 4MB to 256MB per bank
- Programmable timing
- Auto refresh
- Page Mode Accesses with up to 4 open pages
- Power Management (self-refresh)
- Error Checking and Correction (ECC) support
 - Standard single error correct, double error detect coverage
 - Aligned nibble error detect
 - Address error logging

EXTERNAL BUS CONTROLLER (EBC)

- Supports eight ROM, EPROM, SRAM, Flash, and Slave Peripheral I/O banks supported
- Up to 66.66MHz operation
- Burst and non-burst devices
- 8-, 16-, 32-bit byte-addressable data bus width support
- Latch data on Ready, Synchronous or Asynchronous
- Programmable 2K clock-cycle time-out counter with disable for Ready
- Programmable access timing per device
 - 0–255 wait states for non-bursting devices
 - 0 –31 Burst Wait States for first access and up to 7 Wait States for subsequent accesses
 - Programmable chip select assertion/negation relative to driving address bus
 - Programmable output and write-enable assertion/negation relative to assertion of chip select
- Programmable address mapping
- Peripheral device wait via “Ready”
- External master interface
 - Write posting from external master
 - Read prefetching on PLB for external master reads
 - Bursting capable from external master
 - Allows external master access to all non-EBC PLB slaves
 - External master can control EBC slaves for own access and control

DMA CONTROLLER

- Supports the following transfers:
 - Memory-to-memory transfers
 - Buffered peripheral to memory transfers
 - Buffered memory to peripheral transfers
- Four channels
- Scatter/Gather capability for programming multiple DMA operations
- 8-, 16-, 32-bit peripheral support (OPB and external bus attached)
- 32-bit addressing
- Address increment or decrement
- Internal 32-byte data buffering capability
- Supports internal and external peripherals
- Support for memory mapped peripherals
- Support for peripherals running on slower frequency buses

SERIAL INTERFACE

- Two 8-pin UART interfaces provided
- Selectable internal or external serial clock to allow wide range of baud rates
- Register compatibility with NS16550 register set
- Complete status reporting capability
- Transmitter and receiver are each buffered with 16-byte FIFOs when in FIFO mode
- Fully programmable serial-interface characteristics
- Supports DMA using internal DMA engine

IIC BUS INTERFACE

- Compliant with Phillips® Semiconductors I²C Specification, dated 1995
- Operation at 100kHz or 400kHz
- 8-bit data
- 10- or 7-bit address
- Slave transmitter and receiver
- Master transmitter and receiver
- Multiple bus masters
- Supports fixed V_{DD} IIC interface
- Two independent 4 x 1 byte data buffers
- One programmable interrupt request signal
- Provides full management of all IIC bus protocol
- Programmable error recovery

IIC EEPROM CONTROLLER

Supports setting of processor configuration from serial EEPROM during system reset.

HDLC EX INTERFACE

- 32-channel HDLC controller
- Two full-duplex Pulse Code Modulation (PCM) Highway ports at speeds up to 4.096 Mbps per port or 8.192 Mbps when using a single port
- Supports HDLC protocol as well as a Transparent mode
- For a single channel per port, autonomous management of I-Frames and S-Frames of the Normal Response mode (NRM) protocol on one channel per port. U-frames are handled by software.
- Supports software emulation of NRM on all channels

HDLC MP INTERFACE

- HDLC controller provides eight full-duplex serial ports
- Up to 2.048Mbps data rate
- Supports HDLC protocol as well as a Transparent mode
- Software emulation of NRM

GENERAL PURPOSE IO (GPIO) CONTROLLER

- Two GPIO controllers
 - 32-signal system GPIO (GPIO0)
 - 32-signal communications GPIO (GPIO1)
- Most GPIOs are pin-shared with other functions. Configuration registers are provided to determine whether a particular pin that has GPIO capabilities acts as a GPIO or is used for another purpose. Both GPIO functions have 32 I/Os.
- Each GPIO output is separately programmable to emulate an open-drain driver (drives to zero, three-stated if output bit is 1)

UNIVERSAL INTERRUPT CONTROLLER (UIC)

Two cascaded Universal Interrupt Controllers (UICs) provide the control, status, and communications necessary for the interrupt sources and the PowerPC processor.

Features include:

- Seven external and 49 internal interrupts
- Edge triggered or level-sensitive
- Positive or negative active
- Selectable non-critical or critical interrupt requests to the PPC405 processor core
- Programmable critical interrupt priority ordering
- Programmable critical interrupt vector generation for reduced latency interrupt handling

10/100 MBPS ETHERNET MAC

- Four units capable of full- and half-duplex, 10 Mbps or 100 Mbps operation
- Integrated ZMII Bridge supports use of MII, SMII or RMII connections to external PHYs (PHYs not included on chip)
 - Reduced Media Independent Interface (RMII) or Serial Media Independent Interface (SMII) for one to four PHY applications
 - Media Independent Interface (MII) for single or dual PHY applications
- Dedicated media access layer (MAL) provides DMA support

JTAG

- IEEE 1149.1 Test Access Port
- Debugger support
- JTAG boundary scan support (BSDL file available)

PERFORMANCE COUNTERS

A series of software accessible PLB transaction event counters that can be used to analyze PLB performance.

35 MM, 580-BALL E-PBGA PACKAGE

Figure 2. 35mm, 580-Ball E-PBGA Package

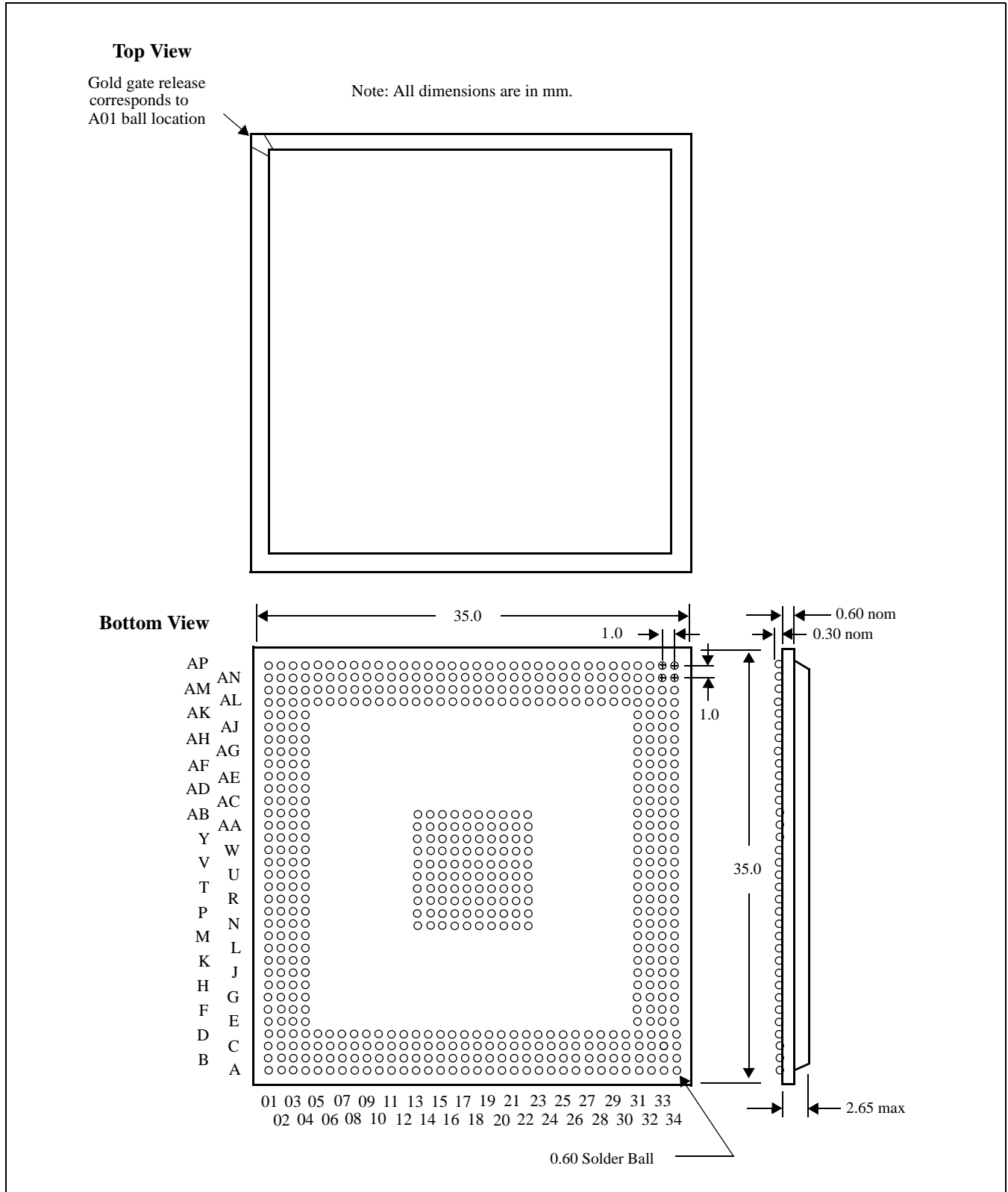

SIGNAL LISTS

The following table lists all the external signals in alphabetical order and shows the ball number on which the signal appears. Multiplexed signals are shown with the default signal (following reset) *not* in brackets and the alternate signal or signals in brackets. Multiplexed signals appear alphabetically multiple times in the list—once for each signal name on the ball. The page number listed gives the page in “Signal Functional Description” on page 43 where the signals in the indicated interface group begin.

SIGNALS LISTED ALPHABETICALLY

Table 3. Signals Listed Alphabetically (Sheet 1 of 17)

Signal Name	Ball	Interface Group	Page
AV _{DD}	P31	Power	51
BA0	AN31	SDRAM	46
BA1	AM31		
$\overline{\text{BankSel0}}$	AL21	SDRAM	46
$\overline{\text{BankSel1}}$	AP23		
$\overline{\text{BankSel2}}$	AM22		
$\overline{\text{BankSel3}}$	AN23		
$[\overline{\text{BE0}}]\text{PCIC0}$	D01	PCI	43
$[\overline{\text{BE1}}]\text{PCIC1}$	B06		
$[\overline{\text{BE2}}]\text{PCIC2}$	B10		
$[\overline{\text{BE3}}]\text{PCIC3}$	C15		
BusReq	H03	External Master Peripheral Bus	49
$\overline{\text{CAS}}$	AN22	SDRAM	46
ClkEn0	AP21	SDRAM	46
ClkEn1	AN21		
$[\overline{\text{DMAAck0}}]\text{GPIO0}_13$	AB34	External Slave Peripheral Bus	47
$[\overline{\text{DMAAck1}}]\text{GPIO0}_14$	AB33		
$[\overline{\text{DMAAck2}}]\text{GPIO0}_15$	AA31		
$[\overline{\text{DMAAck3}}]\text{GPIO0}_16[\text{PerCS5}]$	AC34		
$[\overline{\text{DMAReq0}}]\text{GPIO0}_09$	AA34	External Slave Peripheral Bus	47
$[\overline{\text{DMAReq1}}]\text{GPIO0}_10$	W32		
$[\overline{\text{DMAReq2}}]\text{GPIO0}_11$	AA33		
$[\overline{\text{DMAReq3}}]\text{GPIO0}_12[\text{PerCS4}]$	AA32		
DQM0	AN20	SDRAM	46
DQM1	AN15		
DQM2	AP12		
DQM3	AN09		
DQM _{CB}	AM20	SDRAM	46
ECC0	AP24	SDRAM	46
ECC1	AN24		
ECC2	AM24		
ECC3	AN25		
ECC4	AP26		
ECC5	AM25		
ECC6	AN26		
ECC7	AL25		
EMC0MDCIk	C21	Ethernet	44

Table 3. Signals Listed Alphabetically (Sheet 2 of 17)

Signal Name	Ball	Interface Group	Page
EMC0MDIO	B21	Ethernet	44
[EMC0Sync]EMC0TxEn[EMC0Tx0En]	D21	Ethernet	44
EMC0TxD0[EMC0Tx0D0][EMC0Tx0D]	A24	Ethernet	44
EMC0TxD1[EMC0Tx0D1][EMC0Tx1D]	B23		
EMC0TxD2[EMC0Tx1D0][EMC0Tx2D]	C22		
EMC0TxD3[EMC0Tx1D1][EMC0Tx3D]	A23		
EMC0TxEn[EMC0Tx0En][EMC0Sync]	D21	Ethernet	44
EMC0TxErr[EMC0Tx1En]	A22	Ethernet	44
[EMC0Tx0En]EMC0TxEn[EMC0Sync]	D21	Ethernet	44
[EMC0Tx1En]EMC0TxErr	A22		
[EMC1TxEn][EMC1Tx2En]GPIO1_12[HDLCMPTxEn6]	B30	Ethernet	44
[EMC1TxErr][EMC1Tx3En]GPIO1_11[HDLCMPTxData6]	C29		
[EMC1Tx2En][EMC1TxEn]GPIO1_12[HDLCMPTxEn6]	B30		
[EMC1Tx3En][EMC1TxErr]GPIO1_11[HDLCMPTxData6]	C29		
[EMC1TxD0][EMC1Tx2D0]GPIO1_04[HDLCMPRxData4]	A28	Ethernet	44
[EMC1TxD1][EMC1Tx2D1]GPIO1_05[HDLCMPTxClk5]	C27		
[EMC1TxD2][EMC1Tx3D0]GPIO1_06[HDLCMPTxData5]	B28		
[EMC1TxD3][EMC1Tx3D1]GPIO1_07[HDLCMPTxEn5]	D27		
[EOT0/TC0]GPIO0_24	AF34	External Slave Peripheral Bus	47
[EOT1/TC1]GPIO0_25	AE32		
[EOT2/TC2]GPIO0_26	AF33		
[EOT3/TC3]GPIO0_27[PerCS7]	AE31		
ExtAck	H02	External Master Peripheral Bus	49
ExtReq	J03	External Master Peripheral Bus	49
ExtReset	K03	External Master Peripheral Bus	49

Table 3. Signals Listed Alphabetically (Sheet 3 of 17)

Signal Name	Ball	Interface Group	Page
GND	A01	Power Note: Balls N13-N22, P13-P22, R13-R22, T13-T22, U13-U22, V13-V22, W13-W22, Y13-Y22, AA13-AA22, and AB13-AB22 are also thermal balls.	51
GND	A02		
GND	A06		
GND	A10		
GND	A15		
GND	A20		
GND	A25		
GND	A29		
GND	A33		
GND	A34		
GND	B01		
GND	B02		
GND	B33		
GND	B34		
GND	C03		
GND	C32		
GND	D04		
GND	D12		
GND	D17		
GND	D18		
GND	D23		
GND	D31		
GND	F01		
GND	F34		
GND	K01		
GND	K34		
GND	M04		
GND	M31		
GND	N13–N22		
GND	P13–P22		
GND	R01		
GND	R13–R22		
GND	R34		
GND	T13–T22		
GND	U04		
GND	U13–U22		
GND	U31		

Table 3. Signals Listed Alphabetically (Sheet 4 of 17)

Signal Name	Ball	Interface Group	Page
GND	V04	Power Note: Balls N13-N22, P13-P22, R13-R22, T13-T22, U13-U22, V13-V22, W13-W22, Y13-Y22, AA13-AA22, and AB13-AB22 are also thermal balls.	51
GND	V13–V22		
GND	V31		
GND	W13–W22		
GND	Y13–Y22		
GND	Y01		
GND	Y34		
GND	AA13–AA22		
GND	AB13–AB22		
GND	AC04		
GND	AC31		
GND	AE01		
GND	AE34		
GND	AJ01		
GND	AJ34		
GND	AL04		
GND	AL12		
GND	AL17		
GND	AL18		
GND	AL23		
GND	AL31		
GND	AM03		
GND	AM17		
GND	AM32		
GND	AN01		
GND	AN02		
GND	AN33		
GND	AN34		
GND	AP01		
GND	AP02		
GND	AP06		
GND	AP10		
GND	AP15		
GND	AP20		
GND	AP25		
GND	AP29		
GND	AP33		
GND	AP34		
[Gnt]PCIReq $\bar{0}$	A19	PCI	43

Table 3. Signals Listed Alphabetically (Sheet 5 of 17)

Signal Name	Ball	Interface Group	Page
GPIO0_00	U34	System	51
GPIO0_01[TS1E]	U33		
GPIO0_02[TS2E]	V33		
GPIO0_03[TS1O]	V34		
GPIO0_04[TS2O]	W34		
GPIO0_05[TS3]	W33		
GPIO0_06[TS4]	V32		
GPIO0_07[TS5]	Y33		
GPIO0_08[TS6]	Y32		
GPIO0_09[DMAReq0]	AA34		
GPIO0_10[DMAReq1]	W32		
GPIO0_11[DMAReq2]	AA33		
GPIO0_12[DMAReq3][PerCS4]	AA32		
GPIO0_13[DMAAck0]	AB34		
GPIO0_14[DMAAck1]	AB33		
GPIO0_15[DMAAck2]	AA31		
GPIO0_16[DMAAck3][PerCS5]	AC34		
GPIO0_17[IRQ0]	AB32		
GPIO0_18[IRQ1]	AC33		
GPIO0_19[IRQ2]	AD34		
GPIO0_20[IRQ3]	AC32		
GPIO0_21[IRQ4]	AD33		
GPIO0_22[IRQ5]	AD32		
GPIO0_23[IRQ6][PerCS6]	AE33		
GPIO0_24[EOT0/TC0]	AF34		
GPIO0_25[EOT1/TC1]	AE32		
GPIO0_26[EOT2/TC2]	AF33		
GPIO0_27[EOT3/TC3][PerCS7]	AE31		
GPIO0_28[PerCS1]	AG34		
GPIO0_29[PerCS2]	AF32		
GPIO0_30[PerCS3]	AG33		
GPIO0_31[TrcClk]	AH34		

Table 3. Signals Listed Alphabetically (Sheet 6 of 17)

Signal Name	Ball	Interface Group	Page
GPIO1_00[HDLCMP TxClk4][PHY1Rx2D0][PHY1Rx2D0]	D25	System	51
GPIO1_01[HDLCMP TxData4][PHY1Rx2D1][PHY1Rx2D1]	A27		
GPIO1_02[HDLCMP TxEn4][PHY1Rx2D2][PHY1Rx3D0]	C26		
GPIO1_03[HDLCMP RxClk4][PHY1Rx3D3][PHY1Rx3D1]	B27		
GPIO1_04[HDLCMP RxData4][EMC1Tx2D0][EMC1Tx2D0]	A28		
GPIO1_05[HDLCMP TxClk5][EMC1Tx2D1][EMC1Tx2D1]	C27		
GPIO1_06[HDLCMP TxData5][EMC1Tx2D2][EMC1Tx3D0]	B28		
GPIO1_07[HDLCMP TxEn5][EMC1Tx3D3][EMC1Tx3D1]	D27		
GPIO1_08[HDLCMP RxClk5][PHY1RxErr][PHY1Rx2Er]	C28		
GPIO1_09[HDLCMP RxData5][PHY1Rx2DV][PHY1CrS3DV]	B29		
GPIO1_10[HDLCMP TxClk6][PHY1CrS][PHY1CrS2DV]	A30		
GPIO1_11[HDLCMP TxData6][EMC1TxErr][EMC1Tx3En]	C29		
GPIO1_12[HDLCMP TxEn6][EMC1TxEn][EMC1Tx2En]	B30		
GPIO1_13[HDLCMP RxClk6][PHY1RxClk]	A31		
GPIO1_14[HDLCMP RxData6][PHY1Col][PHY1Rx3Er]	B32		
GPIO1_15[HDLCMP TxClk7]	D29		
GPIO1_16[HDLCMP TxData7]	C30		
GPIO1_17[HDLCMP TxEn7][PHY1TxClk]	A32		
GPIO1_18[HDLCMP RxClk7]	B31		
GPIO1_19[HDLCMP RxData7]	C31		
GPIO1_20[HDLCMP TxEn0][UART1_CTS]	D33		
GPIO1_21[HDLCMP TxEn1][UART1_DSR]	C34		
GPIO1_22[HDLCMP TxEn2][UART1_DCD]	E32		
GPIO1_23[HDLCMP TxEn3][UART1_RI]	F31		
GPIO1_24[HDLCExTxEnA][UART1_RTS]	C33		
GPIO1_25[HDLCExTxEnB][UART1_DTR]	D34		
GPIO1_26[UART0_CTS]	E33		
GPIO1_27[UART0_DSR]	F32		
GPIO1_28[UART0_DCD]	E34		
GPIO1_29[UART0_RI]x	F33		
GPIO1_30[UART0_RTS]	G32		
GPIO1_31[UART0_DTR]	H31		
Halt	N33	System	51
HDLCExRxClk	AJ31	HDLC 32-Channel	44
HDLCExRxDataA	AK33	HDLC 32-Channel	44
HDLCExRxDataB	AL34		
HDLCExRxFS	AM33	HDLC 32-Channel	44
HDLCExTxClk	AL32	HDLC 32-Channel	44
HDLCExTxDataA	AK32	HDLC 32-Channel	44
HDLCExTxDataB	AM34		
[HDLCExTxEnA]GPIO1_24[UART1_RTS]	C33	HDLC 32-Channel	44
[HDLCExTxEnB]GPIO1_25[UART1_DTR]	D34		
HDLCExTxFS	AL33	HDLC 32-Channel	44

Table 3. Signals Listed Alphabetically (Sheet 7 of 17)

Signal Name	Ball	Interface Group	Page
HDLCMPRxClk0	G33	HDLC 8-Port	44
HDLCMPRxClk1	H33		
HDLCMPRxClk2	H34		
HDLCMPRxClk3	N34		
[HDLCMPRxClk4]GPIO1_03[PHY1Rx3D3][PHY1Rx3D1]	B27	HDLC 8-Port	44
[HDLCMPRxClk5]GPIO1_08[PHY1RxErr][PHY1Rx2Er]	C28		
[HDLCMPRxClk6]GPIO1_13[PHY1RxClk]	A31		
[HDLCMPRxClk7]GPIO1_18]	B31		
HDLCMPRxData0	G34	HDLC 8-Port	44
HDLCMPRxData1	J32		
HDLCMPRxData2	K31		
HDLCMPRxData3	P32		
[HDLCMPRxData4]GPIO1_04[EMC1TxD0][EMC1Tx2D0]	A28	HDLC 8-Port	44
[HDLCMPRxData5]GPIO1_09[PHY1RxDV][PHY1CrS3DV]	B29		
[HDLCMPRxData6]GPIO1_14[PHY1Co][PHY1Rx3Er]	B32		
[HDLCMPRxData7]GPIO1_19	C31		
HDLCMPTxClk0	P33	HDLC 8-Port	44
HDLCMPTxClk1	P34		
HDLCMPTxClk2	R33		
HDLCMPTxClk3	T33		
[HDLCMPTxClk4]GPIO1_00[PHY1Rx3D0][PHY1Rx2D0]	D25	HDLC 8-Port	44
[HDLCMPTxClk5]GPIO1_05[EMC1Tx2D1][EMC1Tx2D1]	C27		
[HDLCMPTxClk6]GPIO1_10[PHY1CrS][PHY1CrS2DV]	A30		
[HDLCMPTxClk7]GPIO1_15	D29		
HDLCMPTxData0	T32	HDLC 8-Port	44
HDLCMPTxData1	R32		
HDLCMPTxData2	U32		
HDLCMPTxData3	T34		
[HDLCMPTxData4]GPIO1_01[PHY1Rx2D1][PHY1Rx2D1]	A27	HDLC 8-Port	44
[HDLCMPTxData5]GPIO1_06[EMC1Tx2D2][EMC1Tx3D0]	B28		
[HDLCMPTxData6]GPIO1_11[EMC1TxErr][EMC1Tx3En]	C29		
[HDLCMPTxData7]GPIO1_16	C30		
[HDLCMPTxEn0]GPIO1_20[UART1_CTS]	D33	HDLC 8-Port	44
[HDLCMPTxEn1]GPIO1_21[UART1_DSR]	C34		
[HDLCMPTxEn2]GPIO1_22[UART1_DCD]	E32		
[HDLCMPTxEn3]GPIO1_23[UART1_RI]	F31		
[HDLCMPTxEn4]GPIO1_02[PHYRx3D0]	C26		
[HDLCMPTxEn5]GPIO1_07[EMC0Tx3D1]	D27		
[HDLCMPTxEn6]GPIO1_12[EMC0Tx2En]	B30		
[HDLCMPTxEn7]GPIO1_17[PHY1TxClk]	A32		
HoldAck	H01	External Master Peripheral Bus	49
HoldPri	K04		
HoldReq	J02		
IIC_SCL[IIC_SCL]	AK34	Internal Peripheral Bus	49
IIC_SDA[IIC_SDA]	AJ32		

Table 3. Signals Listed Alphabetically (Sheet 8 of 17)

Signal Name	Ball	Interface Group	Page
[IRQ0]GPIO0_17	AB32	Interrupts	50
[IRQ1]GPIO0_18	AC33		
[IRQ2]GPIO0_19	AD34		
[IRQ3]GPIO0_20	AC32		
[IRQ4]GPIO0_21	AD33		
[IRQ5]GPIO0_22	AD32		
[IRQ6]GPIO0_23[PerCS6]	AE33		
MemAddr00	AP27	SDRAM Note: During a $\overline{\text{CAS}}$ cycle MemAddr00 is the least significant bit (lsb) on this bus.	46
MemAddr01	AM26		
MemAddr02	AN27		
MemAddr03	AN28		
MemAddr04	AM28		
MemAddr05	AN29		
MemAddr06	AP30		
MemAddr07	AM29		
MemAddr08	AN30		
MemAddr09	AP31		
MemAddr10	AL29		
MemAddr11	AM30		
MemAddr12	AP32		
MemClkOut0	AM27	SDRAM	46
MemClkOut1	AP28		

Table 3. Signals Listed Alphabetically (Sheet 9 of 17)

Signal Name	Ball	Interface Group	Page
MemData00	AM18	SDRAM Notes: 1. MemData00 is the most significant bit (msb). 2. MemData31 is the least significant bit (lsb)	46
MemData01	AN19		
MemData02	AP19		
MemData03	AP18		
MemData04	AN18		
MemData05	AN17		
MemData06	AP16		
MemData07	AN16		
MemData08	AM15		
MemData09	AP14		
MemData10	AM16		
MemData11	AN14		
MemData12	AM14		
MemData13	AP13		
MemData14	AN13		
MemData15	AL14		
MemData16	AM13		
MemData17	AN12		
MemData18	AP11		
MemData19	AM12		
MemData20	AN11		
MemData21	AN10		
MemData22	AP09		
MemData23	AM10		
MemData24	AL10		
MemData25	AP08		
MemData26	AM09		
MemData27	AN08		
MemData28	AP07		
MemData29	AM08		
MemData30	AN07		
MemData31	AL08		

Table 3. Signals Listed Alphabetically (Sheet 10 of 17)

Signal Name	Ball	Interface Group	Page
OV _{DD}	A11	Power	51
OV _{DD}	B05		
OV _{DD}	B22		
OV _{DD}	C08		
OV _{DD}	C16		
OV _{DD}	D05		
OV _{DD}	D07		
OV _{DD}	D09		
OV _{DD}	D11		
OV _{DD}	D24		
OV _{DD}	D26		
OV _{DD}	D28		
OV _{DD}	D30		
OV _{DD}	E03		
OV _{DD}	E04		
OV _{DD}	E31		
OV _{DD}	F03		
OV _{DD}	G04		
OV _{DD}	G31		
OV _{DD}	J04		
OV _{DD}	J31		
OV _{DD}	L04		
OV _{DD}	L31		
OV _{DD}	L32		
OV _{DD}	M32		
OV _{DD}	M34		
OV _{DD}	AD04		
OV _{DD}	AD31		
OV _{DD}	AF04		
OV _{DD}	AF31		
OV _{DD}	AH04		
OV _{DD}	AH31		
OV _{DD}	AK04		
OV _{DD}	AK31		

Table 3. Signals Listed Alphabetically (Sheet 11 of 17)

Signal Name	Ball	Interface Group	Page
OV _{DD}	AL05	Power	51
OV _{DD}	AL07		
OV _{DD}	AL09		
OV _{DD}	AL11		
OV _{DD}	AL24		
OV _{DD}	AL26		
OV _{DD}	AL27		
OV _{DD}	AL28		
OV _{DD}	AL30		
OV _{DD}	AM06		
OV _{DD}	AM11		
OV _{DD}	AM19		
OV _{DD}	AM23		
OV _{DD}	AN32		
OV _{DD}	AP17		

Table 3. Signals Listed Alphabetically (Sheet 12 of 17)

Signal Name	Ball	Interface Group	Page
PCIAD00	H04	PCI Note: PCIAD31 is the most significant bit (msb) on this bus.	43
PCIAD01	G01		
PCIAD02	G02		
PCIAD03	G03		
PCIAD04	F02		
PCIAD05	F04		
PCIAD06	E01		
PCIAD07	D03		
PCIAD08	C01		
PCIAD09	C02		
PCIAD10	B03		
PCIAD11	A03		
PCIAD12	C04		
PCIAD13	A04		
PCIAD14	A05		
PCIAD15	C06		
PCIAD16	C11		
PCIAD17	C12		
PCIAD18	B12		
PCIAD19	A12		
PCIAD20	A13		
PCIAD21	B13		
PCIAD22	C14		
PCIAD23	B14		
PCIAD24	B15		
PCIAD25	B16		
PCIAD26	A16		
PCIAD27	C17		
PCIAD28	B17		
PCIAD29	C18		
PCIAD30	B18		
PCIAD31	A18		
PCIC0[BE0]	D01	PCI	43
PCIC1[BE1]	B06		
PCIC2[BE2]	B10		
PCIC3[BE3]	C15		
PCIClk	B11	PCI	43
PCIDevSel	A08	PCI	43
PCIFrame	C10	PCI	43
PCIGnt0[Req]	B19	PCI	43
PCIGnt1	A17		
PCIGnt2	D06		
PCIGnt3	D10		
PCIGnt4	C13		
PCIGnt5	D14		
PCIIDSel	A14	PCI	43

Table 3. Signals Listed Alphabetically (Sheet 13 of 17)

Signal Name	Ball	Interface Group	Page
PCIINT[PerWE]	C05	PCI	43
PCIIRDY	B09	PCI	43
PCIParity	B07	PCI	43
PCIPErr	A07	PCI	43
PCIReq0[Gnt]	A19	PCI	43
PCIReq1	D02		
PCIReq2	E02		
PCIReq3	B04		
PCIReq4	C07		
PCIReq5	A09		
PCIReset	B20	PCI	43
PCISErr	D08	PCI	43
PCIStop	B08	PCI	43
PCITRDY	C09	PCI	43
PerAddr00	AD02	External Slave Peripheral	47
PerAddr01	AC03		
PerAddr02	AD01		
PerAddr03	AC02		
PerAddr04	AB03		
PerAddr05	AC01		
PerAddr06	AA04		
PerAddr07	AB02		
PerAddr08	AB01		
PerAddr09	AA03		
PerAddr10	AA02		
PerAddr11	W03		
PerAddr12	AA01		
PerAddr13	Y03		
PerAddr14	Y02		
PerAddr15	V03		
PerAddr16	W02		
PerAddr17	W01		
PerAddr18	V01		
PerAddr19	V02		
PerAddr20	U02		
PerAddr21	U01		
PerAddr22	T01		
PerAddr23	T02		
PerAddr24	U03		
PerAddr25	R02		
PerAddr26	R03		
PerAddr27	P01		
PerAddr28	T03		
PerAddr29	P02		
PerAddr30	P03		
PerAddr31	N01		

Table 3. Signals Listed Alphabetically (Sheet 14 of 17)

Signal Name	Ball	Interface Group	Page
PerBLast	L03	External Slave Peripheral Bus	47
PerClk	K02	External Slave Peripheral Bus	47
PerCS0	M02	External Slave Peripheral Bus	47
[PerCS1]GPIO0_28	AG34		
[PerCS2]GPIO0_29	AF32		
[PerCS3]GPIO0_30	AG33		
[PerCS4]GPIO0_12[DMAReq3]	AA32		
[PerCS5]GPIO0_16[DMAAck3]	AC34		
[PerCS6]GPIO0_23[IRQ6]	AE33		
[PerCS7]GPIO0_27[EOT3/TC3]	AE31		
PerData00	AM07	External Slave Peripheral Bus Note: PerData00 is the most significant bit (msb) on this bus.	47
PerData01	AN06		
PerData02	AP05		
PerData03	AN05		
PerData04	AP04		
PerData05	AN03		
PerData06	AL06		
PerData07	AM05		
PerData08	AN04		
PerData09	AM04		
PerData10	AL03		
PerData11	AL02		
PerData12	AM01		
PerData13	AK03		
PerData14	AJ04		
PerData15	AM02		
PerData16	AK02		
PerData17	AJ03		
PerData18	AK01		
PerData19	AJ02		
PerData20	AH03		
PerData21	AG04		
PerData22	AH02		
PerData23	AG03		
PerData24	AG02		
PerData25	AF03		
PerData26	AG01		
PerData27	AE04		
PerData28	AF02		
PerData29	AE03		
PerData30	AF01		
PerData31	AE02		
PerErr	J01	External Slave Peripheral Bus	49
PerOE	L01	External Slave Peripheral Bus	47

Table 3. Signals Listed Alphabetically (Sheet 15 of 17)

Signal Name	Ball	Interface Group	Page
PerPar0	AP03	External Slave Peripheral Bus	47
PerPar1	AL01		
PerPar2	AH01		
PerPar3	AD03		
PerR \overline{W}	M03	External Slave Peripheral Bus	47
PerReady	L02	External Slave Peripheral Bus	47
$\overline{\text{PerWBE0}}$	N02	External Slave Peripheral Bus	47
$\overline{\text{PerWBE1}}$	P04		
$\overline{\text{PerWBE2}}$	M01		
$\overline{\text{PerWBE3}}$	N03		
$[\overline{\text{PerWE}}]\text{PCIINT}$	C05	External Slave Peripheral Bus	43
PHY0Col[PHY0Rx1Er]	C20	Ethernet	44
PHY0CrS[PHY0CrS0DV]	A21	Ethernet	44
$[\text{PHY0CrS0DV}]\text{PHY0CrS}$	A21	Ethernet	44
$[\text{PHY0CrS1DV}]\text{PHY0RxDV}$	C23		
$[\text{PHY0RefClk}]\text{PHY0TxClk}$	C19	Ethernet	44
PHY0RxClk	B24	Ethernet	44
PHY0Rx0D0[PHY0Rx0D0][PHY0Rx0D]	B26	Ethernet	44
PHY0Rx0D1[PHY0Rx0D1][PHY0Rx1D]	C25		
PHY0Rx0D2[PHY0Rx1D0][PHY0Rx2D]	A26		
PHY0Rx0D3[PHY0Rx1D1][PHY0Rx3D]	B25		
PHY0Rx0DV[PHY0CrS1DV]	C23	Ethernet	44
PHY0RxErr[PHY0Rx0Er]	C24	Ethernet	44
$[\text{PHY0Rx0Er}]\text{PHY0RxErr}$	C24	Ethernet	44
$[\text{PHY0Rx1Er}]\text{PHY0Col}$	C20		
PHY0TxClk[PHY0RefClk]	C19	Ethernet	44
$[\text{PHY1Col}][\text{PHY1Rx3Er}]\text{GPIO1}_14[\text{HDLCMPrxData6}]$	B32	Ethernet	44
$[\text{PHY1CrS}][\text{PHY1CrS2DV}]\text{GPIO1}_10[\text{HDLCMPTxCIk6}]$	A30	Ethernet	44
$[\text{PHY1CrS2DV}][\text{PHY1CrS}]\text{GPIO1}_10[\text{HDLCMPTxCIk6}]$	A30	Ethernet	44
$[\text{PHY1CrS3DV}][\text{PHY1RxDV}]\text{GPIO1}_09[\text{HDLCMPrxData5}]$	B29	Ethernet	44
$[\text{PHY1RxClk}]\text{GPIO1}_13[\text{HDLCMPrxCIk6}]$	A31	Ethernet	44
$[\text{PHY1RxDV}][\text{PHY1CrS3DV}]\text{GPIO1}_09[\text{HDLCMPrxData5}]$	B29	Ethernet	44
$[\text{PHY1Rx0D0}][\text{PHY1Rx2D0}]\text{GPIO1}_00[\text{HDLCMPTxCIk4}]$	D25	Ethernet	44
$[\text{PHY1Rx0D1}][\text{PHY1Rx2D1}]\text{GPIO1}_01[\text{HDLCMPTxCIk4}]$	A27		
$[\text{PHY1Rx0D2}][\text{PHY1Rx3D0}]\text{GPIO1}_02[\text{HDLCMPTxCIk4}]$	C26		
$[\text{PHY1Rx0D3}][\text{PHY1Rx3D1}]\text{GPIO1}_03[\text{HDLCMPrxCIk4}]$	B27		
$[\text{PHY1RxErr}][\text{PHY1Rx2Er}]\text{GPIO1}_08[\text{HDLCMPrxCIk5}]$	C28	Ethernet	44
$[\text{PHY1Rx2Er}][\text{PHY1RxErr}]\text{GPIO1}_08[\text{HDLCMPrxCIk5}]$	C28	Ethernet	44
$[\text{PHY1Rx3Er}][\text{PHY1Col}]\text{GPIO1}_14[\text{HDLCMPrxData6}]$	B32		
$[\text{PHY1TxClk}]\text{GPIO1}_17[\text{HDLCMPTxCIk7}]$	A32	Ethernet	44
$\overline{\text{RAS}}$	AP22	SDRAM	46
$[\text{Req}]\text{PCI}Gnt0$	B19	PCI	43
Reserved		Other	51
SysClk	L33	System	51
SysErr	K32	System	51
$\overline{\text{SysReset}}$	J33	System	51

Table 3. Signals Listed Alphabetically (Sheet 16 of 17)

Signal Name	Ball	Interface Group	Page
TCK	K33	JTAG	50
[TC0/EOT0]GPIO0_24	AF34	External Slave Peripheral Bus	47
[TC1/EOT1]GPIO0_25	AE32		
[TC2/EOT2]GPIO0_26	AF33		
[TC3/EOT3]GPIO0_27	AE31		
TDI	N32	JTAG	50
TDO	J34	JTAG	50
TestEn	M33	System	51
TmrClk	D32	System	51
TMS	H32	JTAG	50
[TrcClk]GPIO0_31	AH34	Trace	51
TRST	L34	JTAG	50
[TS1E]GPIO0_01	U33	Trace	51
[TS2E]GPIO0_02	V33		
[TS1O]GPIO0_03	V34	Trace	51
[TS2O]GPIO0_04	W34		
[TS3]GPIO0_05	W33	Trace	51
[TS4]GPIO0_06	V32		
[TS5]GPIO0_07	Y33		
[TS6]GPIO0_08	Y32		
[UART0_CTS]GPIO1_26	E33	Internal Peripheral	49
[UART0_DCD]GPIO1_28	E34	Internal Peripheral	49
[UART0_DSR]GPIO1_27	F32	Internal Peripheral	49
[UART0_DTR]GPIO1_31	H31	Internal Peripheral	49
[UART0_RI]GPIO1_29	F33	Internal Peripheral	49
[UART0_RTS]GPIO1_30	G32	Internal Peripheral	49
UART0_Rx	AG32	Internal Peripheral	49
UART0_Tx	AH33	Internal Peripheral	49
[UART1_CTS]GPIO1_20[HDLCMPTxEn0]	D33	Internal Peripheral	49
[UART1_DCD]GPIO1_22[HDLCMPTxEn2]	E32	Internal Peripheral	49
[UART1_DSR]GPIO1_21[HDLCMPTxEn1]	C34	Internal Peripheral	49
[UART1_DTR]GPIO1_25[HDLCMPTxEnB]	D34	Internal Peripheral	49
[UART1_RI]GPIO1_23[HDLCMPTxEn3]	F31	Internal Peripheral	49
[UART1_RTS]GPIO1_24[HDLCMPTxEnA]	C33	Internal Peripheral	49
UART1_Rx	AH32	Internal Peripheral	49
UART1_Tx	AJ33	Internal Peripheral	49
UARTSerClk	AG31	Internal Peripheral	49

Table 3. Signals Listed Alphabetically (Sheet 17 of 17)

Signal Name	Ball	Interface Group	Page
V _{DD}	D13	Power	51
V _{DD}	D15		
V _{DD}	D16		
V _{DD}	D19		
V _{DD}	D20		
V _{DD}	D22		
V _{DD}	N04		
V _{DD}	N31		
V _{DD}	R04		
V _{DD}	R31		
V _{DD}	T04		
V _{DD}	T31		
V _{DD}	W04		
V _{DD}	W31		
V _{DD}	Y04		
V _{DD}	Y31		
V _{DD}	AB04		
V _{DD}	AB31		
V _{DD}	AL13		
V _{DD}	AL15		
V _{DD}	AL16		
V _{DD}	AL19		
V _{DD}	AL20		
V _{DD}	AL22		
\overline{WE}	AM21	SDRAM	46

SIGNALS LISTED BY BALL ASSIGNMENT

Table 4. Signals Listed by Ball Assignment (Sheet 1 of 9)

Signal names followed by an asterisk (*) are multiplexed. Look up the name shown in “Signals Listed Alphabetically” on page 15 for an indication of all signals on the pin.

Ball	Signal Name	Ball	Signal Name	Ball	Signal Name	Ball	Signal Name
A01	GND	B01	GND	C01	PCIAD08	D01	PCIC0[BE0]
A02	GND	B02	GND	C02	PCIAD09	D02	PCIReq1
A03	PCIAD11	B03	PCIAD10	C03	GND	D03	PCIAD07
A04	PCIAD13	B04	PCIReq3	C04	PCIAD12	D04	GND
A05	PCIAD14	B05	OV _{DD}	C05	PCIINT[PerWE]	D05	OV _{DD}
A06	GND	B06	PCIC1[BE1]	C06	PCIAD15	D06	PCI _{Gnt} 2
A07	PCIPErr	B07	PCIParity	C07	PCIReq4	D07	OV _{DD}
A08	PCIDevSel	B08	PCIS _{top}	C08	OV _{DD}	D08	PCISErr
A09	PCIReq5	B09	PCIIRDY	C09	PCITRDY	D09	OV _{DD}
A10	GND	B10	PCIC2[BE2]	C10	PCIFrame	D10	PCI _{Gnt} 3
A11	OV _{DD}	B11	PCIClk	C11	PCIAD16	D11	OV _{DD}
A12	PCIAD19	B12	PCIAD18	C12	PCIAD17	D12	GND
A13	PCIAD20	B13	PCIAD21	C13	PCI _{Gnt} 4	D13	V _{DD}
A14	PCIIDSel	B14	PCIAD23	C14	PCIAD22	D14	PCI _{Gnt} 5
A15	GND	B15	PCIAD24	C15	PCIC3[BE3]	D15	V _{DD}
A16	PCIAD26	B16	PCIAD25	C16	OV _{DD}	D16	V _{DD}
A17	PCI _{Gnt} 1	B17	PCIAD28	C17	PCIAD27	D17	GND
A18	PCIAD31	B18	PCIAD30	C18	PCIAD29	D18	GND
A19	PCIReq0 *	B19	PCI _{Gnt} 0[Req]	C19	PHY0TxClk *	D19	V _{DD}
A20	GND	B20	PCIR _{eset}	C20	PHY0CoI *	D20	V _{DD}
A21	PHY0CrS *	B21	EMC0MDIO	C21	EMC0MDClk	D21	EMC0TxEn *
A22	EMC0TxErr *	B22	OV _{DD}	C22	EMC0TxD2 *	D22	V _{DD}
A23	EMC0TxD3 *	B23	EMC0TxD1 *	C23	PHY0RxDV *	D23	GND
A24	EMC0TxD0 *	B24	PHY0RxClk	C24	PHY0RxErr *	D24	OV _{DD}
A25	GND	B25	PHY0RxD3 *	C25	PHY0RxD1 *	D25	GPIO1_00 *
A26	PHY0RxD2 *	B26	PHY0RxD0 *	C26	GPIO1_02 *	D26	OV _{DD}
A27	GPIO1_01 *	B27	GPIO1_03 *	C27	GPIO1_05 *	D27	GPIO1_07 *
A28	GPIO1_04 *	B28	GPIO1_06 *	C28	GPIO1_08 *	D28	OV _{DD}
A29	GND	B29	GPIO1_09 *	C29	GPIO1_11 *	D29	GPIO1_15 *
A30	GPIO1_10 *	B30	GPIO1_12 *	C30	GPIO1_16 *	D30	OV _{DD}
A31	GPIO1_13 *	B31	GPIO1_18 *	C31	GPIO1_19 *	D31	GND
A32	GPIO1_17 *	B32	GPIO1_14 *]	C32	GND	D32	TmrClk
A33	GND	B33	GND	C33	GPIO1_24 *	D33	GPIO1_20 *
A34	GND	B34	GND	C34	GPIO1_21 *	D34	GPIO1_25 *

Table 4. Signals Listed by Ball Assignment (Sheet 2 of 9)

Signal names followed by an asterisk (*) are multiplexed. Look up the name shown in “Signals Listed Alphabetically” on page 15 for an indication of all signals on the pin.

Ball	Signal Name	Ball	Signal Name	Ball	Signal Name	Ball	Signal Name
E01	PCIAD06	F01	GND	G01	PCIAD01	H01	HoldAck
E02	PCIReq2	F02	PCIAD04	G02	PCIAD02	H02	ExtAck
E03	OV _{DD}	F03	OV _{DD}	G03	PCIAD03	H03	BusReq
E04	OV _{DD}	F04	PCIAD05	G04	OV _{DD}	H04	PCIAD00
E05	No ball	F05	No ball	G05	No ball	H05	No ball
E06	No ball	F06	No ball	G06	No ball	H06	No ball
E07	No ball	F07	No ball	G07	No ball	H07	No ball
E08	No ball	F08	No ball	G08	No ball	H08	No ball
E09	No ball	F09	No ball	G09	No ball	H09	No ball
E10	No ball	F10	No ball	G10	No ball	H10	No ball
E11	No ball	A11	No ball	G11	No ball	H11	No ball
E12	No ball	F12	No ball	G12	No ball	H12	No ball
E13	No ball	F13	No ball	G13	No ball	H13	No ball
E14	No ball	F14	No ball	G14	No ball	H14	No ball
E15	No ball	F15	No ball	G15	No ball	H15	No ball
E16	No ball	F16	No ball	G16	No ball	H16	No ball
E17	No ball	F17	No ball	G17	No ball	H17	No ball
E18	No ball	F18	No ball	G18	No ball	H18	No ball
E19	No ball	F19	No ball	G19	No ball	H19	No ball
E20	No ball	F20	No ball	G20	No ball	H20	No ball
E21	No ball	F21	No ball	G21	No ball	H21	No ball
E22	No ball	F22	No ball	G22	No ball	H22	No ball
E23	No ball	F23	No ball	G23	No ball	H23	No ball
E24	No ball	F24	No ball	G24	No ball	H24	No ball
E25	No ball	F25	No ball	G25	No ball	H25	No ball
E26	No ball	F26	No ball	G26	No ball	H26	No ball
E27	No ball	F27	No ball	G27	No ball	H27	No ball
E28	No ball	F28	No ball	G28	No ball	H28	No ball
E29	No ball	F29	No ball	G29	No ball	H29	No ball
E30	No ball	F30	No ball	G30	No ball	H30	No ball
E31	OV _{DD}	F31	GPIO1_23 *	G31	OV _{DD}	H31	GPIO1_31 *
E32	GPIO1_22 *	F32	GPIO1_27 *	G32	GPIO1_30 *	H32	TMS
E33	GPIO1_26 *	F33	GPIO1_29 *	G33	HDLCMPRxClk0	H33	HDLCMPRxClk1
E34	GPIO1_28 *]	F34	GND	G34	HDLCMPRxData0	H34	HDLCMPRxClk2

Table 4. Signals Listed by Ball Assignment (Sheet 3 of 9)

Signal names followed by an asterisk (*) are multiplexed. Look up the name shown in “Signals Listed Alphabetically” on page 15 for an indication of all signals on the pin.

Ball	Signal Name	Ball	Signal Name	Ball	Signal Name	Ball	Signal Name
J01	PerErr	K01	GND	L01	PerOE	M01	PerWBE2
J02	HoldReq	K02	PerClk	L02	PerReady	M02	PerCS0
J03	ExtReq	K03	ExtReset	L03	PerBLast	M03	PerR \bar{W}
J04	OV _{DD}	K04	HoldPri	L04	OV _{DD}	M04	GND
J05	No ball	K05	No ball	L05	No ball	M05	No ball
J06	No ball	K06	No ball	L06	No ball	M06	No ball
J07	No ball	K07	No ball	L07	No ball	M07	No ball
J08	No ball	K08	No ball	L08	No ball	M08	No ball
J09	No ball	K09	No ball	L09	No ball	M09	No ball
J10	No ball	K10	No ball	L10	No ball	M10	No ball
J11	No ball	K11	No ball	L11	No ball	M11	No ball
J12	No ball	K12	No ball	L12	No ball	M12	No ball
J13	No ball	K13	No ball	L13	No ball	M13	No ball
J14	No ball	K14	No ball	L14	No ball	M14	No ball
J15	No ball	K15	No ball	L15	No ball	M15	No ball
J16	No ball	K16	No ball	L16	No ball	M16	No ball
J17	No ball	K17	No ball	L17	No ball	M17	No ball
J18	No ball	K18	No ball	L18	No ball	M18	No ball
J19	No ball	K19	No ball	L19	No ball	M19	No ball
J20	No ball	K20	No ball	L20	No ball	M20	No ball
J21	No ball	K21	No ball	L21	No ball	M21	No ball
J22	No ball	K22	No ball	L22	No ball	M22	No ball
J23	No ball	K23	No ball	L23	No ball	M23	No ball
J24	No ball	K24	No ball	L24	No ball	M24	No ball
J25	No ball	K25	No ball	L25	No ball	M25	No ball
J26	No ball	K26	No ball	L26	No ball	M26	No ball
J27	No ball	K27	No ball	L27	No ball	M27	No ball
J28	No ball	K28	No ball	L28	No ball	M28	No ball
J29	No ball	K29	No ball	L29	No ball	M29	No ball
J30	No ball	K30	No ball	L30	No ball	M30	No ball
J31	OV _{DD}	K31	HDLCMPRxData2	L31	OV _{DD}	M31	GND
J32	HDLCMPRxData1	K32	SysErr	L32	OV _{DD}	M32	OV _{DD}
J33	SysReset	K33	TCK	L33	SysClk	M33	TestEn
J34	TDO	K34	GND	L34	TRST	M34	OV _{DD}

Table 4. Signals Listed by Ball Assignment (Sheet 4 of 9)

Signal names followed by an asterisk (*) are multiplexed. Look up the name shown in “Signals Listed Alphabetically” on page 15 for an indication of all signals on the pin.

Ball	Signal Name	Ball	Signal Name	Ball	Signal Name	Ball	Signal Name
N01	PerAddr31	P01	PerAddr27	R01	GND	T01	PerAddr22
N02	$\overline{\text{PerWBE0}}$	P02	PerAddr29	R02	PerAddr25	T02	PerAddr23
N03	$\overline{\text{PerWBE3}}$	P03	PerAddr30	R03	PerAddr26	T03	PerAddr28
N04	V _{DD}	P04	$\overline{\text{PerWBE1}}$	R04	V _{DD}	T04	V _{DD}
N05	No ball	P05	No ball	R05	No ball	T05	No ball
N06	No ball	P06	No ball	R06	No ball	T06	No ball
N07	No ball	P07	No ball	R07	No ball	T07	No ball
N08	No ball	P08	No ball	R08	No ball	T08	No ball
N09	No ball	P09	No ball	R09	No ball	T09	No ball
N10	No ball	P10	No ball	R10	No ball	T10	No ball
N11	No ball	P11	No ball	R11	No ball	T11	No ball
N12	No ball	P12	No ball	R12	No ball	T12	No ball
N13	GND	P13	GND	R13	GND	T13	GND
N14	GND	P14	GND	R14	GND	T14	GND
N15	GND	P15	GND	R15	GND	T15	GND
N16	GND	P16	GND	R16	GND	T16	GND
N17	GND	P17	GND	R17	GND	T17	GND
N18	GND	P18	GND	R18	GND	T18	GND
N19	GND	P19	GND	R19	GND	T19	GND
N20	GND	P20	GND	R20	GND	T20	GND
N21	GND	P21	GND	R21	GND	T21	GND
N22	GND	P22	GND	R22	GND	T22	GND
N23	No ball	P23	No ball	R23	No ball	T23	No ball
N24	No ball	P24	No ball	R24	No ball	T24	No ball
N25	No ball	P25	No ball	R25	No ball	T25	No ball
N26	No ball	P26	No ball	R26	No ball	T26	No ball
N27	No ball	P27	No ball	R27	No ball	T27	No ball
N28	No ball	P28	No ball	R28	No ball	T28	No ball
N29	No ball	P29	No ball	R29	No ball	T29	No ball
N30	No ball	P30	No ball	R30	No ball	T30	No ball
N31	V _{DD}	P31	AV _{DD}	R31	V _{DD}	T31	V _{DD}
N32	TDI	P32	HDLCMPRxData3	R32	HDLCMPTxData1	T32	HDLCMPTxData0
N33	$\overline{\text{Halt}}$	P33	HDLCMPTxCIk0	R33	HDLCMPTxCIk2	T33	HDLCMPTxCIk3
N34	HDLCMPRxCIk3	P34	HDLCMPTxCIk1	R34	GND	T34	HDLCMPTxData3

Table 4. Signals Listed by Ball Assignment (Sheet 5 of 9)

Signal names followed by an asterisk (*) are multiplexed. Look up the name shown in “Signals Listed Alphabetically” on page 15 for an indication of all signals on the pin.

Ball	Signal Name	Ball	Signal Name	Ball	Signal Name	Ball	Signal Name
U01	PerAddr21	V01	PerAddr18	W01	PerAddr17	Y01	GND
U02	PerAddr20	V02	PerAddr19	W02	PerAddr16	Y02	PerAddr14
U03	PerAddr24	V03	PerAddr15	W03	PerAddr11	Y03	PerAddr13
U04	GND	V04	GND	W04	V _{DD}	Y04	V _{DD}
U05	No ball	V05	No ball	W05	No ball	Y05	No ball
U06	No ball	V06	No ball	W06	No ball	Y06	No ball
U07	No ball	V07	No ball	W07	No ball	Y07	No ball
U08	No ball	V08	No ball	W08	No ball	Y08	No ball
U09	No ball	V09	No ball	W09	No ball	Y09	No ball
U10	No ball	V10	No ball	W10	No ball	Y10	No ball
U11	No ball	V11	No ball	W11	No ball	Y11	No ball
U12	No ball	V12	No ball	W12	No ball	Y12	No ball
U13	GND	V13	GND	W13	GND	Y13	GND
U14	GND	V14	GND	W14	GND	Y14	GND
U15	GND	V15	GND	W15	GND	Y15	GND
U16	GND	V16	GND	W16	GND	Y16	GND
U17	GND	V17	GND	W17	GND	Y17	GND
U18	GND	V18	GND	W18	GND	Y18	GND
U19	GND	V19	GND	W19	GND	Y19	GND
U20	GND	V20	GND	W20	GND	Y20	GND
U21	GND	V21	GND	W21	GND	Y21	GND
U22	GND	V22	GND	W22	GND	Y22	GND
U23	No ball	V23	No ball	W23	No ball	Y23	No ball
U24	No ball	V24	No ball	W24	No ball	Y24	No ball
U25	No ball	V25	No ball	W25	No ball	Y25	No ball
U26	No ball	V26	No ball	W26	No ball	Y26	No ball
U27	No ball	V27	No ball	W27	No ball	Y27	No ball
U28	No ball	V28	No ball	W28	No ball	Y28	No ball
U29	No ball	V29	No ball	W29	No ball	Y29	No ball
U30	No ball	V30	No ball	W30	No ball	Y30	No ball
U31	GND	V31	GND	W31	V _{DD}	Y31	V _{DD}
U32	HDLCMPTxData2	V32	GPIO0_06 *	W32	GPIO0_10 *	Y32	GPIO0_08 *
U33	GPIO0_01 *	V33	GPIO0_02 *	W33	GPIO0_05 *	Y33	GPIO0_07 *
U34	GPIO0_00	V34	GPIO0_03 *	W34	GPIO0_04 *	Y34	GND

Table 4. Signals Listed by Ball Assignment (Sheet 6 of 9)

Signal names followed by an asterisk (*) are multiplexed. Look up the name shown in “Signals Listed Alphabetically” on page 15 for an indication of all signals on the pin.

Ball	Signal Name	Ball	Signal Name	Ball	Signal Name	Ball	Signal Name
AA01	PerAddr12	AB01	PerAddr08	AC01	PerAddr05	AD01	PerAddr02
AA02	PerAddr10	AB02	PerAddr07	AC02	PerAddr03	AD02	PerAddr00
AA03	PerAddr09	AB03	PerAddr04	AC03	PerAddr01	AD03	PerPar3
AA04	PerAddr06	AB04	V _{DD}	AC04	GND	AD04	OV _{DD}
AA05	No ball	AB05	No ball	AC05	No ball	AD05	No ball
AA06	No ball	AB06	No ball	AC06	No ball	AD06	No ball
AA07	No ball	AB07	No ball	AC07	No ball	AD07	No ball
AA08	No ball	AB08	No ball	AC08	No ball	AD08	No ball
AA09	No ball	AB09	No ball	AC09	No ball	AD09	No ball
AA10	No ball	AB10	No ball	AC10	No ball	AD10	No ball
AA11	No ball	AB11	No ball	AC11	No ball	AD11	No ball
AA12	No ball	AB12	No ball	AC12	No ball	AD12	No ball
AA13	GND	AB13	GND	AC13	No ball	AD13	No ball
AA14	GND	AB14	GND	AC14	No ball	AD14	No ball
AA15	GND	AB15	GND	AC15	No ball	AD15	No ball
AA16	GND	AB16	GND	AC16	No ball	AD16	No ball
AA17	GND	AB17	GND	AC17	No ball	AD17	No ball
AA18	GND	AB18	GND	AC18	No ball	AD18	No ball
AA19	GND	AB19	GND	AC19	No ball	AD19	No ball
AA20	GND	AB20	GND	AC20	No ball	AD20	No ball
AA21	GND	AB21	GND	AC21	No ball	AD21	No ball
AA22	GND	AB22	GND	AC22	No ball	AD22	No ball
AA23	No ball	AB23	No ball	AC23	No ball	AD23	No ball
AA24	No ball	AB24	No ball	AC24	No ball	AD24	No ball
AA25	No ball	AB25	No ball	AC25	No ball	AD25	No ball
AA26	No ball	AB26	No ball	AC26	No ball	AD26	No ball
AA27	No ball	AB27	No ball	AC27	No ball	AD27	No ball
AA28	No ball	AB28	No ball	AC28	No ball	AD28	No ball
AA29	No ball	AB29	No ball	AC29	No ball	AD29	No ball
AA30	No ball	AB30	No ball	AC30	No ball	AD30	No ball
AA31	GPIO0_15 *	AB31	V _{DD}	AC31	GND	AD31	OV _{DD}
AA32	GPIO0_12 *	AB32	GPIO0_17 *	AC32	GPIO0_20 *	AD32	GPIO0_22 *
AA33	GPIO0_11 *	AB33	GPIO0_14 *	AC33	GPIO0_18 *	AD33	GPIO0_21 *
AA34	GPIO0_09 *	AB34	GPIO0_13 *	AC34	GPIO0_16 *	AD34	GPIO0_19 *

Table 4. Signals Listed by Ball Assignment (Sheet 7 of 9)

Signal names followed by an asterisk (*) are multiplexed. Look up the name shown in “Signals Listed Alphabetically” on page 15 for an indication of all signals on the pin.

Ball	Signal Name	Ball	Signal Name	Ball	Signal Name	Ball	Signal Name
AE01	GND	AF01	PerData30	AG01	PerData26	AH01	PerPar2
AE02	PerData31	AF02	PerData28	AG02	PerData24	AH02	PerData22
AE03	PerData29	AF03	PerData25	AG03	PerData23	AH03	PerData20
AE04	PerData27	AF04	OV _{DD}	AG04	PerData21	AH04	OV _{DD}
AE05	No ball	AF05	No ball	AG05	No ball	AH05	No ball
AE06	No ball	AF06	No ball	AG06	No ball	AH06	No ball
AE07	No ball	AF07	No ball	AG07	No ball	AH07	No ball
AE08	No ball	AF08	No ball	AG08	No ball	AH08	No ball
AE09	No ball	AF09	No ball	AG09	No ball	AH09	No ball
AE10	No ball	AF10	No ball	AG10	No ball	AH10	No ball
AE11	No ball	AF11	No ball	AG11	No ball	AH11	No ball
AE12	No ball	AF12	No ball	AG12	No ball	AH12	No ball
AE13	No ball	AF13	No ball	AG13	No ball	AH13	No ball
AE14	No ball	AF14	No ball	AG14	No ball	AH14	No ball
AE15	No ball	AF15	No ball	AG15	No ball	AH15	No ball
AE16	No ball	AF16	No ball	AG16	No ball	AH16	No ball
AE17	No ball	AF17	No ball	AG17	No ball	AH17	No ball
AE18	No ball	AF18	No ball	AG18	No ball	AH18	No ball
AE19	No ball	AF19	No ball	AG19	No ball	AH19	No ball
AE20	No ball	AF20	No ball	AG20	No ball	AH20	No ball
AE21	No ball	AF21	No ball	AG21	No ball	AH21	No ball
AE22	No ball	AF22	No ball	AG22	No ball	AH22	No ball
AE23	No ball	AF23	No ball	AG23	No ball	AH23	No ball
AE24	No ball	AF24	No ball	AG24	No ball	AH24	No ball
AE25	No ball	AF25	No ball	AG25	No ball	AH25	No ball
AE26	No ball	AF26	No ball	AG26	No ball	AH26	No ball
AE27	No ball	AF27	No ball	AG27	No ball	AH27	No ball
AE28	No ball	AF28	No ball	AG28	No ball	AH28	No ball
AE29	No ball	AF29	No ball	AG29	No ball	AH29	No ball
AE30	No ball	AF30	No ball	AG30	No ball	AH30	No ball
AE31	GPIO0_27 *	AF31	OV _{DD}	AG31	UARTSerClk	AH31	OV _{DD}
AE32	GPIO0_25 *	AF32	GPIO0_29 *	AG32	UART0_Rx	AH32	UART1_Rx
AE33	GPIO0_23 *	AF33	GPIO0_26 *	AG33	GPIO0_30 *	AH33	UART0_Tx
AE34	GND	AF34	GPIO0_24 *	AG34	GPIO0_28 *	AH34	GPIO0_31 *

Table 4. Signals Listed by Ball Assignment (Sheet 8 of 9)

Signal names followed by an asterisk (*) are multiplexed. Look up the name shown in “Signals Listed Alphabetically” on page 15 for an indication of all signals on the pin.

Ball	Signal Name	Ball	Signal Name	Ball	Signal Name	Ball	Signal Name
AJ01	GND	AK01	PerData18	AL01	PerPar1	AM01	PerData12
AJ02	PerData19	AK02	PerData16	AL02	PerData11	AM02	PerData15
AJ03	PerData17	AK03	PerData13	AL03	PerData10	AM03	GND
AJ04	PerData14	AK04	OV _{DD}	AL04	GND	AM04	PerData09
AJ05	No ball	AK05	No ball	AL05	OV _{DD}	AM05	PerData07
AJ06	No ball	AK06	No ball	AL06	PerData06	AM06	OV _{DD}
AJ07	No ball	AK07	No ball	AL07	OV _{DD}	AM07	PerData00
AJ08	No ball	AK08	No ball	AL08	MemData31	AM08	MemData29
AJ09	No ball	AK09	No ball	AL09	OV _{DD}	AM09	MemData26
AJ10	No ball	AK10	No ball	AL10	MemData24	AM10	MemData23
AJ11	No ball	AK11	No ball	AL11	OV _{DD}	AM11	OV _{DD}
AJ12	No ball	AK12	No ball	AL12	GND	AM12	MemData19
AJ13	No ball	AK13	No ball	AL13	V _{DD}	AM13	MemData16
AJ14	No ball	AK14	No ball	AL14	MemData15	AM14	MemData12
AJ15	No ball	AK15	No ball	AL15	V _{DD}	AM15	MemData08
AJ16	No ball	AK16	No ball	AL16	V _{DD}	AM16	MemData10
AJ17	No ball	AK17	No ball	AL17	GND	AM17	GND
AJ18	No ball	AK18	No ball	AL18	GND	AM18	MemData00
AJ19	No ball	AK19	No ball	AL19	V _{DD}	AM19	OV _{DD}
AJ20	No ball	AK20	No ball	AL20	V _{DD}	AM20	DQMCB
AJ21	No ball	AK21	No ball	AL21	BankSel0	AM21	WE
AJ22	No ball	AK22	No ball	AL22	V _{DD}	AM22	BankSel2
AJ23	No ball	AK23	No ball	AL23	GND	AM23	OV _{DD}
AJ24	No ball	AK24	No ball	AL24	OV _{DD}	AM24	ECC2
AJ25	No ball	AK25	No ball	AL25	ECC7	AM25	ECC5
AJ26	No ball	AK26	No ball	AL26	OV _{DD}	AM26	MemAddr01
AJ27	No ball	AK27	No ball	AL27	OV _{DD}	AM27	MemClkOut0
AJ28	No ball	AK28	No ball	AL28	OV _{DD}	AM28	MemAddr04
AJ29	No ball	AK29	No ball	AL29	MemAddr10	AM29	MemAddr07
AJ30	No ball	AK30	No ball	AL30	OV _{DD}	AM30	MemAddr11
AJ31	HDLCEXRxCik	AK31	OV _{DD}	AL31	GND	AM31	BA1
AJ32	IICSDA[IICSDA]	AK32	HDLCEXTxDataA	AL32	HDLCEXTxCik	AM32	GND
AJ33	UART1_Tx	AK33	HDLCEXRxDatA	AL33	HDLCEXTxFS	AM33	HDLCEXRxFs
AJ34	GND	AK34	IICSCL[IICscl]	AL34	HDLCEXRxDatB	AM34	HDLCEXTxDatB

Table 4. Signals Listed by Ball Assignment (Sheet 9 of 9)

Signal names followed by an asterisk (*) are multiplexed. Look up the name shown in “Signals Listed Alphabetically” on page 15 for an indication of all signals on the pin.

Ball	Signal Name	Ball	Signal Name	Ball	Signal Name	Ball	Signal Name
AN01	GND	AP01	GND				
AN02	GND	AP02	GND				
AN03	PerData05	AP03	PerPar0				
AN04	PerData08	AP04	PerData04				
AN05	PerData03	AP05	PerData02				
AN06	PerData01	AP06	GND				
AN07	MemData30	AP07	MemData28				
AN08	MemData27	AP08	MemData25				
AN09	DQM3	AP09	MemData22				
AN10	MemData21	AP10	GND				
AN11	MemData20	AP11	MemData18				
AN12	MemData17	AP12	DQM2				
AN13	MemData14	AP13	MemData13				
AN14	MemData11	AP14	MemData09				
AN15	DQM1	AP15	GND				
AN16	MemData07	AP16	MemData06				
AN17	MemData05	AP17	OV _{DD}				
AN18	MemData04	AP18	MemData03				
AN19	MemData01	AP19	MemData02				
AN20	DQM0	AP20	GND				
AN21	ClkEn1	AP21	ClkEn0				
AN22	CAS	AP22	RAS				
AN23	BankSel3	AP23	BankSel1				
AN24	ECC1	AP24	ECC0				
AN25	ECC3	AP25	GND				
AN26	ECC6	AP26	ECC4				
AN27	MemAddr02	AP27	MemAddr00				
AN28	MemAddr03	AP28	MemClkOut1				
AN29	MemAddr05	AP29	GND				
AN30	MemAddr08	AP30	MemAddr06				
AN31	BA0	AP31	MemAddr09				
AN32	OV _{DD}	AP32	MemAddr12				
AN33	GND	AP33	GND				
AN34	GND	AP34	GND				

SIGNAL DESCRIPTION

The following table provides a summary of the number of package pins (balls) associated with each functional interface group.

PIN SUMMARY

Table 5. Pin Summary

Group	No. of Pins
Nonmultiplexed Signals	256
Multiplexed Signals	85
Total Signal Pins	341
AV _{DD}	1
OV _{DD}	49
V _{DD}	24
Gnd	65
Gnd (and thermal)	100
Reserved	0
Total Pins	580

Multiplexed Pins

In the table “Signal Functional Description” on page 43, each external signal is listed along with a short description of the signal function. The signals are grouped together according to their function. Some signals are multiplexed on the same package pin (ball) so that the pin can be used for different functions. In most cases, the signal name is shown in this table unaccompanied by multiplexed signal names that may be associated with it. In cases where multiplexed signals are in the same functional group, the names appear as a default signal followed by secondary signals in square brackets (for example, EMC0TxErr[EMC0Tx1En]). Active-low signals (for example, $\overline{\text{RAS}}$) are marked with an overline. Any signal that is not the primary (default) signal on a multiplexed pin is shown in square brackets.

The active signal on a multiplexed pin is controlled by programming. It is expected that in any single application, a particular pin will always be programmed to serve the same function. The flexibility of multiplexing allows a single chip to offer a richer pin selection than would otherwise be possible.

Multipurpose Pins

In addition to multiplexing, pins may also be multipurpose. An example of multi-purpose use occurs when the EBC peripheral controller address pins are used as outputs by the NPe405H to broadcast an address to external slave devices when the NPe405H has control of the external bus. However, when an external master gains ownership of the external bus, these same pins are used as inputs which are driven by the external master and received by the EBC in the NPe405H. In this example, the pins are also bidirectional, serving as both inputs and outputs.

Initialization Strapping

One group of pins is used as strapped inputs during system reset. These pins function as strapped inputs only during reset and are used for other functions during normal operation (see “Initialization” on page 68). Note that the use of these pins for strapping is not considered multiplexing since the strapping function is not programmable.

Pull-up and Pull-down Resistors

Pull-up and pull-down resistors are used for strapping during reset and to retain unused or undriven inputs in an appropriate state. The recommended pull-up value of 3k Ω to +3.3V (10k Ω to +5V can be used on 5V tolerant I/Os) and pull-down value of 1k Ω to GND, applies only to individually terminated signals. To prevent possible damage to the device, I/Os capable of becoming outputs *must never* be tied together and terminated through a common resistor.

If your system-level test methodology permits, input-only signals can be connected together and terminated through either a common resistor or directly to +3.3V or GND. When a resistor is used, its value must ensure that the grouped I/Os reach a valid logic zero or logic one state when accounting for the total input current into the NPe405H.

Unused I/Os

Strapping of some pins may be necessary when they are unused. Although the NPe405H requires only the pull-up and pull-down terminations as specified in the “Signal Functional Description” on page 43, good design practice is to terminate all unused inputs or to configure I/Os such that they always drive. If unused, the peripheral, SDRAM, and PCI buses should be configured and terminated as follows:

- Peripheral interface—PerAddr00:31, PerData00:31, and all of the control signals are driven by default. Terminate PerReady high and PerError low.
- SDRAM—Program SDRAM0_CFG[EMDULR]=1 and SDRAM0_CFG[DCE]=1. This causes the NPe405H to actively drive all of the SDRAM address, data, and control signals.
- PCI—Configure the PCI controller to park on the bus and actively drive PCIAD31:0, PCIC3:0[$\overline{\text{BE}}3:0$], and the remaining PCI control signals by doing the following:
 - Strap the NPe405H to disable the internal PCI arbiter.
 - Individually connect $\overline{\text{PCIS}}\text{Err}$, $\overline{\text{PCIP}}\text{Err}$, $\overline{\text{PCITRDY}}$, and $\overline{\text{PCIS}}\text{top}$ through 3.3k Ω resistors to +3.3V.
 - Terminate $\overline{\text{PCIR}}\text{eq1:5}$ to +3.3V.
 - Terminate $\overline{\text{PCIR}}\text{eq0}[\overline{\text{Gnt}}]$ to GND.

External Peripheral Bus Control Signals

All external peripheral bus control signals ($\overline{\text{PerCS}}0:7$, $\overline{\text{PerR}}/\overline{\text{W}}$, $\overline{\text{PerWB}}\text{E}0:3$, $\overline{\text{PerOE}}$, $\overline{\text{PerWE}}$, $\overline{\text{PerBL}}\text{ast}$, HoldAck, $\overline{\text{ExtAck}}$) are set to the high-impedance state when $\overline{\text{ExtReset}}=0$. In addition, as detailed in the *PowerNP NPe405H Embedded Processor User's Manual*, the peripheral bus controller can be programmed via EBC0_CFG to float some of these control signals between transactions or when an external master owns the peripheral bus. As a result, a pull-up resistor should be added to those control signals where an undriven state may affect any devices receiving that particular signal.

The following table lists all of the I/O signals provided by the NPe405H. Please see “Signals Listed Alphabetically” on page 15 for the pin number to which each signal is assigned. In cases where a multiplexed signal (indicated by the square brackets) is shown without the other signals that are assigned to that pin, you can see what the other signals are by referring to the same table.

SIGNAL FUNCTIONAL DESCRIPTION

Table 6. Signal Functional Description (Sheet 1 of 9)

Notes:

1. Receiver input has hysteresis.
2. Must pull up. See “Pull-up and Pull-down Resistors” on page 42 for recommended termination values.
3. Must pull down. See “Pull-up and Pull-down Resistors” on page 42 for recommended termination values.
4. If not used, must pull up.
5. If not used, must pull down.
6. Strapping input during reset; pull up or pull down as required.
7. Pull-up may be required. See “External Peripheral Bus Control Signals” on page 42.

Signal Name	Description	I/O	Type	Notes
PCI Interface				
PCIAD0:31	PCI Address/Data bus. Multiplexed address and data bus	I/O	5V tolerant 3.3V PCI	
PCIC3:0[BE3:0]	PCI bus command or Byte Enable	I/O	5V tolerant 3.3V PCI	
PCIParity	PCI Parity. Parity is even across PCIAD0:31 and PCIC0:3[BE0:3]. PCIParity is valid one cycle after either an address or data phase. The PCI device that drove PCIAD0:31 is responsible for driving PCIParity on the next PCI bus clock.	I/O	5V tolerant 3.3V PCI	
PCIFrame	Driven by the current PCI bus master to indicate the beginning and duration of a PCI access.	I/O	5V tolerant 3.3V PCI	4
PCIIRDY	Driven by the current PCI bus master. Assertion of PCIIRDY indicates that the PCI initiator is ready to transfer data.	I/O	5V tolerant 3.3V PCI	4
PCITRDY	The target of the current PCI transaction drives PCITRDY. Assertion of PCITRDY indicates that the PCI target is ready to transfer data.	I/O	5V tolerant 3.3V PCI	4
PCIStop	The target of the current PCI transaction can assert PCIStop to indicate to the requesting PCI master that it wants to end the current transaction.	I/O	5V tolerant 3.3V PCI	4
PCIDevSel	Driven by the target of the current PCI transaction. A PCI target asserts PCIDevSel when it has decoded an address and command encoding and claims the transaction.	I/O	5V tolerant 3.3V PCI	4
PCIIDSel	Used during configuration cycles to select the PCI slave interface for configuration	I	5V tolerant 3.3V PCI	5
PCISErr	Used for reporting address parity errors or catastrophic failures detected by a PCI target.	I/O	5V tolerant 3.3V PCI	4
PCIPErr	Used for reporting data parity errors on PCI transactions. PCIPErr is driven active by the device receiving PCIAD0:31, PCIC0:3[BE0:3], and PCIParity, two PCI clocks following the data in which bad parity is detected.	I/O	5V tolerant 3.3V PCI	4
PCIClk	Used as the asynchronous PCI clock.	I	5V tolerant 3.3V PCI	
PCIReset	PCI specific reset	O	5V tolerant 3.3V PCI	
PCIINT	PCI Interrupt. Open-drain output (two states; 0 or open circuit).	O	5V tolerant 3.3V PCI	
PCIReq0[Gnt]	Req0 when internal arbiter is used, or Gnt when external arbiter is used. IF PCI bus is used, pull this signal up; otherwise, pull down.	I	5V tolerant 3.3V PCI	
PCIReq1:5	Used as PCIReq1:5 input when internal arbiter is used	I	5V tolerant 3.3V PCI	4
PCIGnt0[Req]	Gnt0 when internal arbiter is used, or Req when external arbiter is used	O	5V tolerant 3.3V PCI	

Table 6. Signal Functional Description (Sheet 2 of 9)

Notes:

1. Receiver input has hysteresis.
2. Must pull up. See “Pull-up and Pull-down Resistors” on page 42 for recommended termination values.
3. Must pull down. See “Pull-up and Pull-down Resistors” on page 42 for recommended termination values.
4. If not used, must pull up.
5. If not used, must pull down.
6. Strapping input during reset; pull up or pull down as required.
7. Pull-up may be required. See “External Peripheral Bus Control Signals” on page 42.

Signal Name	Description	I/O	Type	Notes
PCIGnt1:5	PCIGnt1:5 output when internal arbiter is used.	O	5V tolerant 3.3V PCI	
HDLCEX Interface				
HDLCEXTxCIk	Transmit Clock	I	3.3V LVTTTL	
HDLCEXTxFS	Transmit Frame Synchronization	I	3.3V LVTTTL	
HDLCEXTxDataA	Transmit Data port A	O	3.3V LVTTTL	
HDLCEXTxDataB	Transmit Data port B	O	3.3V LVTTTL	
HDLCEXRxCIk	Receive Clock	I	3.3V LVTTTL	
HDLCEXRxFS	Receive Frame Synchronization	I	3.3V LVTTTL	
HDLCEXRxDataA	Receive Data port A	I	3.3V LVTTTL	
HDLCEXRxDataB	Receive Data port B	I	3.3V LVTTTL	
[HDLCEXTxEnA]	Transmit Enable port A	O	5V tolerant 3.3V LVTTTL	
[HDLCEXTxEnB]	Transmit Enable port B	O	5V tolerant 3.3V LVTTTL	
HDLCMP Interface				
HDLCMPTxCIk0:3	Transmit Clock signal that controls the transmit bit rate	O	3.3V LVTTTL	
[HDLCMPTxCIk4:7]	Transmit Clock signal that controls the transmit bit rate	O	5V tolerant 3.3V LVTTTL	
HDLCMPTxData0:3	Transmit Data signal	O	3.3V LVTTTL	
[HDLCMPTxData4:7]	Transmit Data signal	O	5V tolerant 3.3V LVTTTL	
[HDLCMPTxEn0:7]	Transmit Data Enable signal that controls when the external buffer is tri-stated	O	5V tolerant 3.3V LVTTTL	
HDLCMPRxCIk0:3	Receive Clock signal that controls the receive bit rate	I	3.3V LVTTTL	
[HDLCMPRxCIk4:7]	Receive Clock signal that controls the receive bit rate	I	5V tolerant 3.3V LVTTTL	
HDLCMPRxData0:3	Receive Data signal	I	3.3V LVTTTL	
[HDLCMPRxData4:7]	Receive Data signal	I	5V tolerant 3.3V LVTTTL	
Ethernet Interface				
EMC0MDCIk	Management Data Clock. The MDCIk is sourced to the PHY. Management information is transferred synchronously with respect to this clock (MII, RMII, and SMII).	O	3.3V LVTTTL	
EMC0MDIO	Management Data Input/Output is a bidirectional signal between the Ethernet controller and the PHY. It is used to transfer control and status information (MII, RMII, and SMII).	I/O	5V tolerant 3.3V LVTTTL	1, 4

Table 6. Signal Functional Description (Sheet 3 of 9)

Notes:

1. Receiver input has hysteresis.
2. Must pull up. See “Pull-up and Pull-down Resistors” on page 42 for recommended termination values.
3. Must pull down. See “Pull-up and Pull-down Resistors” on page 42 for recommended termination values.
4. If not used, must pull up.
5. If not used, must pull down.
6. Strapping input during reset; pull up or pull down as required.
7. Pull-up may be required. See “External Peripheral Bus Control Signals” on page 42.

Signal Name	Description	I/O	Type	Notes
EMC0TxD0[EMC0Tx0D0][EMC0Tx0D] EMC0TxD1[EMC0Tx0D1][EMC0Tx1D] EMC0TxD2[EMC0Tx1D0][EMC0Tx2D] EMC0TxD3[EMC0Tx1D1][EMC0Tx3D]	Transmit Data. A nibble wide data bus towards the net. The data is synchronous with PHY0TxClk (MII 0[RMII 0, 1][SMII 0, 1, 2, 3]).	O	3.3V LVTTTL	
[EMC1TxD0][EMC1Tx2D0] [EMC1TxD1][EMC1Tx2D1] [EMC1TxD2][EMC1Tx3D0] [EMC1TxD3][EMC1Tx3D1]	RMII Transmit Data (MII 1[RMII 2, 3]).	O	5V tolerant 3.3V LVTTTL	
EMC0TxEn[EMC0Tx0En][EMC0Sync]	Transmit Enable. This signal is driven by EMAC2 to the PHY. Data is valid during the active state of this signal. Deassertion of this signal indicates end of frame transmission. This signal is synchronous with PHYTxClk (MII 0[RMII 0]). or SMII Sync.	O	3.3V LVTTTL	
EMC0TxErr[EMC0Tx1En]	Transmit Error. This signal is generated by the Ethernet controller, is connected to the PHY and is synchronous with the PHY0TxClk. It informs the PHY that an error was detected (MII 0). or Transmit Enable [RMII 1].	O	3.3V LVTTTL	
[EMC1TxEn][EMC1Tx2En]	Transmit Enable ([MII 1][RMII 2]).	O	5V tolerant 3.3V LVTTTL	
[EMC1TxErr][EMC1Tx3En]	Transmit Error. This signal is generated by the Ethernet controller, is connected to the PHY and is synchronous with the PHY1TxClk. It informs the PHY that an error was detected ([MII 1]). or Transmit Enable [RMII 3].	O	5V tolerant 3.3V LVTTTL	
PHY0Col[PHY0Rx1Er]	Collision [receive error] signal from the PHY. This is an asynchronous signal (MII 0). or Receive Error ([RMII 1]).	I	5V tolerant 3.3V LVTTTL	
PHY0CrS[PHY0CrS0DV]	Carrier Sense signal from the PHY. This is an asynchronous signal (MII 0). or Carrier sense data valid ([RMII 0]).	I	5V tolerant 3.3V LVTTTL	1, 5
PHY0RxClk	Receiver medium clock. This signal is generated by the PHY (MII 0).	I	5V tolerant 3.3V LVTTTL	1, 4
PHY0RxD0[PHY0Rx0D0][PHY0Rx0D] PHY0RxD1[PHY0Rx0D1][PHY0Rx1D] PHY0RxD2[PHY0Rx1D0][PHY0Rx2D] PHY0RxD3[PHY0Rx1D1][PHY0Rx3D]	Received Data. This is a nibble wide bus from the PHY. The data is synchronous with PHY0RxClk (MII 0[RMII 0, 1][SMII 0, 1, 2, 3]).	I	5V tolerant 3.3V LVTTTL	1, 4
[PHY1RxD0][PHY1Rx2D0] [PHY1RxD1][PHY1Rx2D1] [PHY1RxD2][PHY1Rx3D0] [PHY1RxD3][PHY1Rx3D1]	Receive Data (MII 1[RMII 2, 3]).	I	5V tolerant 3.3V LVTTTL	

Table 6. Signal Functional Description (Sheet 4 of 9)

Notes:

1. Receiver input has hysteresis.
2. Must pull up. See “Pull-up and Pull-down Resistors” on page 42 for recommended termination values.
3. Must pull down. See “Pull-up and Pull-down Resistors” on page 42 for recommended termination values.
4. If not used, must pull up.
5. If not used, must pull down.
6. Strapping input during reset; pull up or pull down as required.
7. Pull-up may be required. See “External Peripheral Bus Control Signals” on page 42.

Signal Name	Description	I/O	Type	Notes
PHY0RxDV[PHY0CrS1DV]	Receive Data Valid. Data on the Data Bus is valid when this signal is activated. Deassertion of this signal indicates end of the frame reception (MII 0). or Carrier sense data valid ([RMII 1])	I	5V tolerant 3.3V LVTTTL	1, 5
PHY0RxErr[PHY0Rx0Er]	Receive Error. This signal comes from the PHY and is synchronous with PHY0RxClk (MII 0 [RMII 0]).	I	5V tolerant 3.3V LVTTTL	1, 5
PHY0TxClk[PHY0RefClk]	Transmit medium clock. This signal is generated the PHY ([MII 0]). or Reference Clock [RMII and SMII].	I	5V tolerant 3.3V LVTTTL	1, 4
[PHY1Col][PHY1Rx3Er]	Collision [receive error] signal from the PHY. This is an asynchronous signal ([MII 1]). or Receive Error. This signal comes from the PHY and is synchronous with PHY1RxClk ([RMII 3]).	I	5V tolerant 3.3V LVTTTL	1, 5
[PHY1CrS][PHY1CrS2DV]	Carrier Sense signal from the PHY. This is an asynchronous signal ([MII 1]). or Carrier Sense Data Valid ([RMII 2]).	I	5V tolerant 3.3V LVTTTL	
[PHY1RxClk]	Receiver medium clock. This signal is generated by the PHY ([MII 1]).	I	5V tolerant 3.3V LVTTTL	1, 4
[PHY1RxDV][PHY1CrS3DV]	Receive Data Valid ([MII 1]). or Carrier Sense Data Valid ([RMII 3]).	I	5V tolerant 3.3V LVTTTL	
[PHY1RxErr][PHY1Rx2Er]	Receive Error. This signal comes from the PHY and is synchronous with PHY1RxClk ([MII 1][RMII 2]).	I	5V tolerant 3.3V LVTTTL	
[PHY1TxClk]	Transmit medium clock. This signal is generated the PHY ([MII 1]).	I	5V tolerant 3.3V LVTTTL	1, 4

SDRAM Interface

MemAddr00:31	Memory Data bus Notes: 1. MemAddr00 is the most significant bit (msb). 2. MemData31 is the least significant bit (lsb).	I/O	3.3V LVTTTL	
MemAddr12:00	Memory Address bus. Notes: 1. MemAddr12 is the most significant bit (msb). 2. MemAddr00 is the least significant bit (lsb).	O	3.3V LVTTTL	
BA1:0	Bank Address supporting up to 4 internal banks	O	3.3V LVTTTL	
RAS	Row Address Strobe.	O	3.3V LVTTTL	
CAS	Column Address Strobe.	O	3.3V LVTTTL	
DQM0:3	DQM for byte lane 0 (MemAddr00:7), 1 (MemAddr08:15), 2 (MemData16:23), and 3 (MemData24:31)	O	3.3V LVTTTL	

Table 6. Signal Functional Description (Sheet 5 of 9)

Notes:

1. Receiver input has hysteresis.
2. Must pull up. See “Pull-up and Pull-down Resistors” on page 42 for recommended termination values.
3. Must pull down. See “Pull-up and Pull-down Resistors” on page 42 for recommended termination values.
4. If not used, must pull up.
5. If not used, must pull down.
6. Strapping input during reset; pull up or pull down as required.
7. Pull-up may be required. See “External Peripheral Bus Control Signals” on page 42.

Signal Name	Description	I/O	Type	Notes
DQMCB	DQM for ECC check bits.	O	3.3V LVTTTL	
ECC0:7	ECC check bits 0:7.	I/O	3.3V LVTTTL	
$\overline{\text{BankSel0:3}}$	Select up to four external SDRAM banks.	O	3.3V LVTTTL	
$\overline{\text{WE}}$	Write Enable.	O	3.3V LVTTTL	
ClkEn0:1	SDRAM Clock Enable.	O	3.3V LVTTTL	
MemClkOut0:1	Two copies of an SDRAM clock allows, in some cases, glueless SDRAM attachment without requiring this signal to be repowered by a PLL or zero-delay buffer.	O	3.3V LVTTTL	
External Slave Peripheral Bus Interface				
PerData00:31	External peripheral data bus when not in external master mode, otherwise used by external master. Note: PerData00 is the most significant bit (msb) on this bus.	I/O	5V tolerant 3.3V LVTTTL	1
PerAddr00:31	External peripheral address bus when not in external master mode, otherwise used by external master.	I/O	5V tolerant 3.3V LVTTTL	1
PerPar0:3	External peripheral byte parity signals.	I/O	5V tolerant 3.3V LVTTTL	1
$\overline{\text{PerWBE0:3}}$	Peripheral write-byte enable. Byte-enables which are valid for an entire cycle or write-byte-enables which are valid for each byte on each data transfer, allowing partial word transactions. Used by either external bus controller or DMA controller depending upon the type of transfer involved. Used as inputs when external bus master owns the external interface.	I/O	5V tolerant 3.3V LVTTTL	1, 2, 7
$[\overline{\text{PerWE}}]$	Peripheral write enable. Low when any of the four $\overline{\text{PerWBE}}$ signals are low.	I/O	5V tolerant 3.3V LVTTTL	7
$\overline{\text{PerCS0}}$ $[\overline{\text{PerCS1:7}}]$	Peripheral Chip Selects	O	5V tolerant 3.3V LVTTTL	
$\overline{\text{PerOE}}$	Peripheral output enable. Used by either the external bus controller or the DMA controller depending upon the type of transfer involved. When the NPe405H is the bus master, it enables the peripherals to drive the bus.	O	5V tolerant 3.3V LVTTTL	7
PerR $\overline{\text{W}}$	Peripheral read/write. Used when not in external master mode by either the external bus controller or DMA controller depending upon the type of transfer involved. High indicates a read from memory, low indicates a write to memory. Otherwise it used by the external master as an input to indicate the direction of transfer.	I/O	5V tolerant 3.3V LVTTTL	1
PerReady	Indicates peripheral is ready to transfer data.	I	5V tolerant 3.3V LVTTTL	1
$\overline{\text{PerBLast}}$	Peripheral burst last. Used to indicate the last transfer of a memory access.	I/O	5V tolerant 3.3V LVTTTL	1, 7
PerClk	Peripheral Clock. Used by an external master and by synchronous peripheral slaves.	O	5V tolerant 3.3V LVTTTL	
PerErr	Used to indicate errors from peripherals.	I	5V tolerant 3.3V LVTTTL	1, 5

Table 6. Signal Functional Description (Sheet 6 of 9)

Notes:

1. Receiver input has hysteresis.
2. Must pull up. See “Pull-up and Pull-down Resistors” on page 42 for recommended termination values.
3. Must pull down. See “Pull-up and Pull-down Resistors” on page 42 for recommended termination values.
4. If not used, must pull up.
5. If not used, must pull down.
6. Strapping input during reset; pull up or pull down as required.
7. Pull-up may be required. See “External Peripheral Bus Control Signals” on page 42.

Signal Name	Description	I/O	Type	Notes
$\overline{\text{DMAReq0:3}}$	DMA request. Used by peripheral slaves to request a data transfer. Following a system reset, the default mode of the signals is active-low. They may be programmed to active-high using the DMA0_POL register.	I	5V tolerant 3.3V LVTTTL	1
$\overline{\text{DMAAck0:3}}$	DMA acknowledge. Used to indicate to peripherals that data transfer is complete. Following a system reset, the default mode of the signals is active-low. They may be programmed to active-high using the DMA0_POL register.	O	5V tolerant 3.3V LVTTTL	
$\overline{\text{EOT0:3}}/\overline{\text{TC0:3}}$	End Of Transfer/Terminal Count. Indication by peripherals that all data has been transferred, or by DMA controller that programmed amount of data has been transferred. Following a system reset, the default mode of the signals is active-low. They may be programmed to active-high using the DMA0_POL register.	I/O	5V tolerant 3.3V LVTTTL	1

Table 6. Signal Functional Description (Sheet 7 of 9)

Notes:

1. Receiver input has hysteresis.
2. Must pull up. See “Pull-up and Pull-down Resistors” on page 42 for recommended termination values.
3. Must pull down. See “Pull-up and Pull-down Resistors” on page 42 for recommended termination values.
4. If not used, must pull up.
5. If not used, must pull down.
6. Strapping input during reset; pull up or pull down as required.
7. Pull-up may be required. See “External Peripheral Bus Control Signals” on page 42.

Signal Name	Description	I/O	Type	Notes
External Master Peripheral Interface				
$\overline{\text{ExtReset}}$	Peripheral Reset. Used by an external master and synchronous peripheral slaves.	O	5V tolerant 3.3V LVTTTL	
HoldReq	Hold Request. Used by an external master to request ownership of the peripheral bus.	I	5V tolerant 3.3V LVTTTL	1, 5
HoldAck	Hold Acknowledge. Used by the NPe405H to transfer ownership of peripheral bus to an external master.	O	5V tolerant 3.3V LVTTTL	6
$\overline{\text{ExtReq}}$	External Request. Used by an external master to indicate it is prepared to transfer data.	I	5V tolerant 3.3V LVTTTL	1
$\overline{\text{ExtAck}}$	External Acknowledgement. Used by the NPe405H to indicate that a data transfer occurred.	O	5V tolerant 3.3V LVTTTL	6
HoldPri	Hold Primary. Used by an external master to indicate the priority of a given transfer (0 = high, 1 = low).	I	5V tolerant 3.3V LVTTTL	1
BusReq	Bus Request. Used when the NPe405H needs to regain control of peripheral interface from an external Master.	O	5V tolerant 3.3V LVTTTL	
Internal Peripheral Interface				
UARTSerCik	Serial Clock used to provide an alternative clock to the internally generated serial clock. Used in cases where the allowable internally generated baud rates are not satisfactory. This input can be individually connected to either or both UART0 and UART1.	I	5V tolerant 3.3V LVTTTL	1
UART0_Rx	UART0 Receive data.	I	5V tolerant 3.3V LVTTTL	1
UART0_Tx	UART0 Transmit data.	O	5V tolerant 3.3V LVTTTL	
$[\overline{\text{UART0_DCD}}]$	UART0 Data Carrier Detect.	I	5V tolerant 3.3V LVTTTL	1
$[\overline{\text{UART0_DSR}}]$	UART0 Data Set Ready.	I	5V tolerant 3.3V LVTTTL	1
$[\overline{\text{UART0_CTS}}]$	UART0 Clear To Send.	I	5V tolerant 3.3V LVTTTL	1
$[\overline{\text{UART0_DTR}}]$	UART0 Data Terminal Ready.	O	5V tolerant 3.3V LVTTTL	
$[\overline{\text{UART0_RTS}}]$	UART0 Request To Send.	O	5V tolerant 3.3V LVTTTL	
$[\overline{\text{UART0_RI}}]$	UART0 Ring Indicator.	I	5V tolerant 3.3V LVTTTL r	1

Table 6. Signal Functional Description (Sheet 8 of 9)

Notes:

1. Receiver input has hysteresis.
2. Must pull up. See “Pull-up and Pull-down Resistors” on page 42 for recommended termination values.
3. Must pull down. See “Pull-up and Pull-down Resistors” on page 42 for recommended termination values.
4. If not used, must pull up.
5. If not used, must pull down.
6. Strapping input during reset; pull up or pull down as required.
7. Pull-up may be required. See “External Peripheral Bus Control Signals” on page 42.

Signal Name	Description	I/O	Type	Notes
UART1_Rx	UART1 Receive data.	I	5V tolerant 3.3V LVTTTL	1
UART1_Tx	UART1 Transmit data.	O	5V tolerant 3.3V LVTTTL	6
$\overline{\text{[UART1_DCD]}}$	UART1 Data Carrier Detect.	I	5V tolerant 3.3V LVTTTL	1, 4
$\overline{\text{[UART1_DSR]}}$	UART1 Data Set Ready.	I	5V tolerant 3.3V LVTTTL	1, 4
$\overline{\text{[UART1_CTS]}}$	UART1 Clear To Send.	I	5V tolerant 3.3V LVTTTL	1, 4
$\overline{\text{[UART1_DTR]}}$	UART1 Data Terminal Ready.	O	5V tolerant 3.3V LVTTTL	
$\overline{\text{[UART1_RTS]}}$	UART1 Request To Send.	O	5V tolerant 3.3V LVTTTL	
$\overline{\text{[UART1_RI]}}$	UART1 Ring Indicator.	I	5V tolerant 3.3V LVTTTL	1, 4
IIC_SCL[IIECSCL]	IIC [Initialization PROM] Serial Clock.	I/O	5V tolerant 3.3V LVTTTL	1, 2
IIC_SDA[IIECSDA]	IIC [Initialization PROM] Serial Data.	I/O	5V tolerant 3.3V LVTTTL	1, 2
Interrupts Interface				
[IRQ0:6]	Interrupt Requests.	I	5V tolerant 3.3V LVTTTL	1
JTAG Interface				
TDI	Test Data In.	I	5V tolerant 3.3V LVTTTL	1, 4
TMS	Test Mode Select.	I	5V tolerant 3.3V LVTTTL	1, 4
TDO	Test Data Out.	O	5V tolerant 3.3V LVTTTL	
TCK	Test Clock.	I	5V tolerant 3.3V LVTTTL	1, 4
$\overline{\text{TRST}}$	Test Reset. $\overline{\text{TRST}}$ must be low at power-on to reset the JTAG boundary scan state machine.	I	5V tolerant 3.3V LVTTTL	5

Table 6. Signal Functional Description (Sheet 9 of 9)

Notes:

1. Receiver input has hysteresis.
2. Must pull up. See “Pull-up and Pull-down Resistors” on page 42 for recommended termination values.
3. Must pull down. See “Pull-up and Pull-down Resistors” on page 42 for recommended termination values.
4. If not used, must pull up.
5. If not used, must pull down.
6. Strapping input during reset; pull up or pull down as required.
7. Pull-up may be required. See “External Peripheral Bus Control Signals” on page 42.

Signal Name	Description	I/O	Type	Notes
System Interface				
SysClk	Main System Clock input.	I	3.3V Analog Wire w/ESD	
$\overline{\text{SysReset}}$	Main System Reset.	I/O	5V tolerant 3.3V LVTTTL	1, 2
SysErr	Set to 1 when a Machine Check is generated.	O	5V tolerant 3.3V LVTTTL	
$\overline{\text{Halt}}$	Halt from external debugger.	I	5V tolerant 3.3V LVTTTL	1
GPIO0_00:31	System General Purpose I/O.	I/O	5V tolerant 3.3V LVTTTL	
GPIO1_00:31	Communications General Purpose I/O.	I/O	5V tolerant 3.3V LVTTTL	
TestEn	Test Enable. Used only for manufacturing tests. Pull down for normal operation.	I	3.3V LVTTTL Rcvr w/PD	
TmrClk	This input must toggle at a rate of less than one half the CPU core frequency (less than 100MHz in most cases). In most cases this input toggles much slower (in the 1MHz to 10MHz range).	I	5V tolerant 3.3V LVTTTL	1
Trace Interface				
[TS1E] [TS2E]	Even Trace execution status. To access this function, software must toggle a DCR bit.	O	5V tolerant 3.3V LVTTTL	
[TS1O] [TS2O]	Odd Trace execution status. To access this function, software must toggle a DCR bit.	O	5V tolerant 3.3V LVTTTL	
[TS3:6]	Trace Status. To access this function, software must toggle a DCR bit.	O	5V tolerant 3.3V LVTTTL	
[TrcClk]	Trace interface clock. A toggling signal that is always half of the CPU core frequency. To access this function, software must toggle a DCR bit.	O	5V tolerant 3.3V LVTTTL	1
Power Pins				
GND	Ground Note: J09-J14, K09-K14, L09-L14, M09-M14, N09-N14, and P09-P14 are also thermal balls.	I	Hardwire	
V _{DD}	Logic voltage—2.5V	I	Hardwire	
OV _{DD}	Output driver voltage—3.3V	I	Hardwire	
AV _{DD}	Filtered PLL voltage—2.5V	I	3.3V DC Wire w/ESD	
Other Pins				
Reserved	Do not connect signals, voltage, or ground to these pins.	n/a	n/a	

ABSOLUTE MAXIMUM RATINGS

Table 7. Absolute Maximum Ratings

The absolute maximum ratings below are stress ratings only. Operation at or beyond these maximum ratings can cause permanent damage to the device.

Characteristic	Symbol	Value	Unit
Supply Voltage (Internal Logic)	V_{DD}	0 to +2.7	V
Supply Voltage (I/O Interface)	OV_{DD}	0 to +3.6	V
PLL Supply Voltage ²	AV_{DD}	0 to +2.7	V
Input Voltage (3.3V LVTTTL receivers)	V_{IN}	-0.6 to ($OV_{DD} + 0.6$)	V
Input Voltage (5.0V LVTTTL receivers)	V_{IN}	-0.6 to ($OV_{DD} + 2.4$)	V
Storage Temperature Range	T_{STG}	-55 to +150	°C
Case temperature under bias	T_C	-40 to +120	°C

Notes:

1. All voltages are specified with respect to ground (GND).
2. AV_{DD} should be derived from V_{DD} using the following circuit:

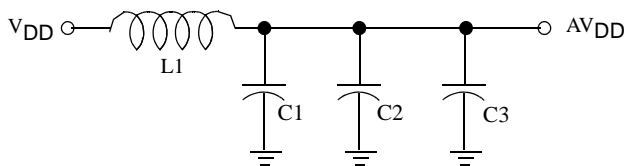

- L1 – 2.2 μ H SMT inductor (equivalent to MuRata LQH3C2R2M34) or SMT chip ferrite bead (equivalent to MuRata BLM31A700S)
- C1 – 3.3 μ F SMT tantalum
- C2 – 0.1 μ F SMT monolithic ceramic capacitor with X7R dielectric or equivalent
- C3 – 0.01 μ F SMT monolithic ceramic capacitor with X7R dielectric or equivalent

PACKAGE THERMAL SPECIFICATIONS

Table 8. Package Thermal Specifications

The NPe405H is designed to operate within a case temperature range of -40°C to 85°C. Thermal resistance values for the E-PBGA packages in a convection environment are as follows:

Package—Thermal Resistance	Symbol	Airflow ft/min (m/sec)			Unit
		0 (0)	100 (0.51)	200 (1.02)	
35mm, 580-balls—Junction-to-Case	θ_{JC}	2	2	2	°C/W
35mm, 580-balls—Case-to-Ambient ¹	θ_{CA}	13	12	11	°C/W

Notes:

1. For a chip mounted on a JEDEC 2S2P card without a heat sink.
2. For a chip mounted on a card with at least one signal and two power planes, the following relationships exist:
 - a. Case temperature, T_C , is measured at top center of case surface with device soldered to circuit board.
 - b. $T_A = T_C - P \times \theta_{CA}$, where T_A is ambient temperature and P is power consumption.
 - c. $T_{CMax} = T_{JMax} - P \times \theta_{JC}$, where T_{JMax} is maximum junction temperature and P is power consumption.

RECOMMENDED DC OPERATING CONDITIONS

Table 9. Recommended DC Operating Conditions

Device operation beyond the conditions specified is not recommended. Extended operation beyond the recommended conditions can affect device reliability.

Notes:

1. PCI drivers meet PCI specifications.

Parameter	Symbol	Minimum	Typical	Maximum	Unit	Notes
Logic Supply Voltage	V _{DD}	+2.3	+2.5	+2.7	V	
I/O Supply Voltage	OV _{DD}	+3.0	+3.3	+3.6	V	
PLL Supply Voltage	AV _{DD}	+2.3	+2.5	+2.7	V	
Input Logic High (3.3V LVTTTL receivers)	V _{IH}	+2.0		OV _{DD}	V	
Input Logic High (2.5V CMOS receivers)	V _{IH}	+1.7		V _{DD}	V	
Input Logic High (5.0V LVTTTL receivers)	V _{IH}	+2.0		+5.5	V	
Input Logic Low	V _{IL}	0		+0.8	V	
Output Logic High	V _{OH}	+2.4		OV _{DD}	V	
Output Logic Low	V _{OL}	0		+0.4	V	
3.3V I/O input current (no pull-up or pull-down)	I _{IL1}			±10	µA	
Input Current (with internal pull-down)	I _{IL2}	±10 (@ 0V)		400 (@ 3.6V)	µA	
Input Current (with internal pull-up)	I _{IL3}	-250 (@ 0V)		±10 (@ 3.6V)	µA	
Input Max Allowable Overshoot (2.5V CMOS receivers)	V _{IMAO25}			V _{DD} + 0.6	V	
Input Max Allowable Overshoot (3.3V LVTTTL receivers)	V _{IMAO3}			OV _{DD} + 0.6	V	
Input Max Allowable Overshoot (5.0V LVTTTL receivers)	V _{IMAO5}			+5.5	V	
Input Max Allowable Undershoot (3.3V or 5.0V receivers)	V _{IMAU}	- 0.6			V	
Output Max Allowable Overshoot (3.3V or 5.0V receivers)	V _{OMAO}			OV _{DD} + 0.3	V	
Output Max Allowable Undershoot (3.3V and 5.0V receivers)	V _{OMAU3}	- 0.6			V	
Case Temperature	T _C	- 40		+85	°C	

Notes:

1. See "" on page 54

5 V-TOLERANT I/O INPUT CURRENT

Figure 3. 5V-Tolerant I/O Input Current

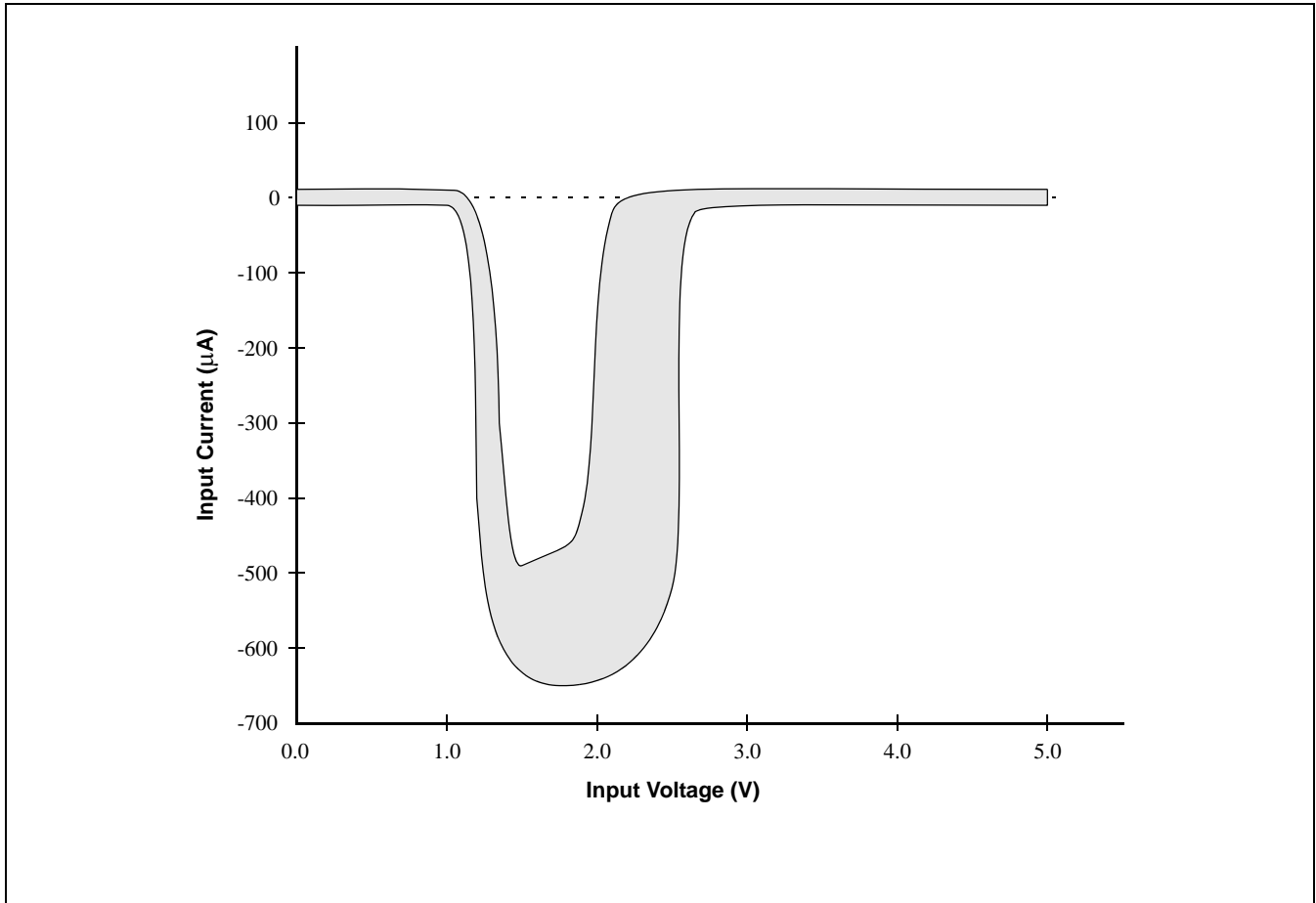

INPUT CAPACITANCE

Table 10. Input Capacitance

Parameter	Symbol	Maximum	Unit	Notes
3.3V LVTTTL I/O)	C _{IN1}	2.5	pF	
5V tolerant LVTTTL I/O	C _{IN2}	3.5	pF	
PCI I/O	C _{IN3}	5.0	pF	
RX only pins	C _{IN4}	0.75	pF	

DC ELECTRICAL CHARACTERISTICS

Table 11. DC Electrical Characteristics

Parameter	Symbol	Minimum	Typical	Maximum	Unit
Active Operating Current for V _{DD} @ 133MHz	I _{DD}	599	669	740	mA
Active Operating Current for V _{DD} @ 200MHz	I _{DD}	755	843	928	mA
Active Operating Current for V _{DD} @ 266MHz	I _{DD}	964	1074	1183	mA
Active Operating Current for OV _{DD} @ 133MHz	I _{ODD}	77	89	99	mA
Active Operating Current for OV _{DD} @ 200MHz	I _{ODD}	89	102	112	mA
Active Operating Current for OV _{DD} @ 266MHz	I _{ODD}	97	111	123	mA
Active Operating Current for AV _{DD}	I _{ADD}	5.5	6	6.5	mA
Active Operating Power @ 133MHz	P _{DD}	1.6	2	2.4 ¹	W
Active Operating Power @ 200MHz	P _{DD}	2	2.4	2.9 ¹	W
Active Operating Power @ 266MHz	P _{DD}	2.5	3	3.6 ¹	W

Notes:

1. Maximum power is characterized at V_{DD}=2.7V, OV_{DD}=3.6V, T_C=85°C, across the silicon process (worse case to best case), while running an application designed to maximize power consumption. The maximum power values are measured with the following clock rate combinations:
 - a. CPU=133.33MHz, PLB=66.66MHz, OPB=66.66MHz, EBC=33.33MHz, PCI=33.33MHz
 - b. CPU=200 MHz, PLB=100MHz, OPB=50MHz, EBC=50MHz, PCI=33.33MHz
 - c. CPU=266.66MHz, PLB=133.33MHz, OPB=66.66MHz, EBC=66.66MHz, PCI=33.33MHz

TEST CONDITIONS

Clock timing and switching characteristics are specified in accordance with operating conditions shown in the table “Recommended DC Operating Conditions.” AC specifications are characterized at OV_{DD} = 3.00V and T_J = 85°C with the 50pF test load shown in the figure at right.

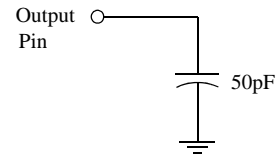

CLOCKING SPECIFICATIONS

Table 12. Clocking Specifications

Symbol	Parameter	Min	Max	Units
SysClk Input				
F_C	SysClk clock input frequency	25	66.66	MHz
T_C	SysClk clock period	15	40	ns
T_{CS}	Clock edge stability (phase jitter, cycle to cycle)		0.15	ns
T_{CH}	Clock input high time	40% of nominal period	60% of nominal period	ns
T_{CL}	Clock input low time	40% of nominal period	60% of nominal period	ns
Note: Input slew rate > 2V/ns				
MemClkOut Output				
F_C	MemClkOut clock output frequency–133MHz		66.66	MHz
T_C	MemClkOut clock period–133MHz	15		ns
F_C	MemClkOut clock output frequency–200MHz		100	MHz
T_C	MemClkOut clock period–200MHz	10		ns
F_C	MemClkOut clock output frequency–266MHz		133.33	MHz
T_C	MemClkOut clock period–266MHz	7.5		ns
T_{CH}	Clock output high time	45% of nominal period	55% of nominal period	ns
T_{CL}	Clock output low time	45% of nominal period	55% of nominal period	ns
Other Clocks				
F_C	VCO frequency	400	800	MHz
F_C	PLB frequency–133MHz		66.66	MHz
F_C	PLB frequency–200MHz		100	MHz
F_C	PLB frequency–266MHz		133.33	MHz
F_C	OPB frequency–133MHz		50 ¹	MHz
F_C	OPB frequency–200MHz		50	MHz
F_C	OPB frequency–266MHz		50 ¹	MHz

Notes:

1. If HDLCEX is not used, the maximum OPB frequency is 66.66MHz.

CLOCKING WAVEFORM

Figure 4. Clocking Waveform

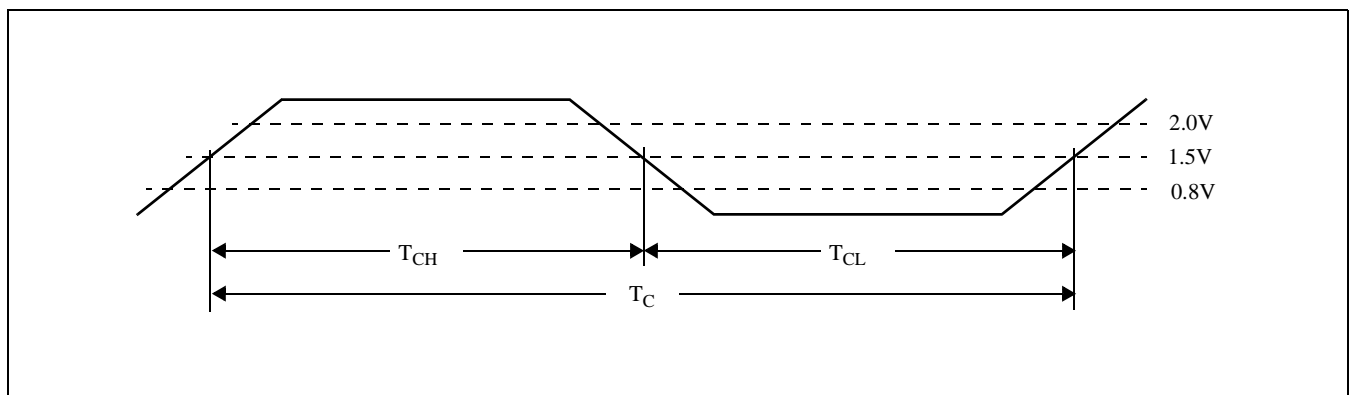

SPREAD SPECTRUM CLOCKING

Care must be taken when using a spread spectrum clock generator (SSCG) with the NPe405H. This controller uses a PLL for clock generation inside the chip. The accuracy with which the PLL follows the SSCG is referred to as tracking skew. The PLL bandwidth and phase angle determine how much tracking skew there is between the SSCG and the PLL for a given frequency deviation and modulation frequency. When using an SSCG with the NPe405H the following conditions must be met:

- The frequency deviation must not violate the minimum clock cycle time. Therefore, when operating the NPe405H with one or more internal clocks at their maximum supported frequency, the SSCG can only lower the frequency.
- The maximum frequency deviation cannot exceed –3%, and the modulation frequency cannot exceed 40kHz. In some cases, on-board NPe405H peripherals impose more stringent requirements (see Note 1).
- Use the peripheral bus clock (PerClk) for logic that is synchronous to the peripheral bus since this clock tracks the modulation.
- Use the SDRAM MemClkOut since it also tracks the modulation.

Please refer to the application note *Using a Spread Spectrum Clock Generator with the PowerPC 405GP* for additional details. This application note is available on the AMCC web site at <http://www.amcc.com>.

Notes:

1. The serial port baud rates are synchronous to the modulated clock. The serial port has a tolerance of approximately 1.5% on baud rate before framing errors begin to occur. The 1.5% tolerance assumes that the connected device is running at precise baud rates. If an external serial clock is used the baud rate is unaffected by the modulation.
2. Ethernet operation is unaffected.
3. IIC operation is unaffected.
4. The PCI clock specification for 66MHz allows a maximum frequency deviation of –1% at a modulation between 30kHz and 33kHz. PCI asynchronous mode is unaffected.

Caution: It is up to the system designer to ensure that any SSCG used with the NPe405H meets the above requirements and does not adversely affect other aspects of the system.

PERIPHERAL INTERFACE CLOCK TIMINGS

Table 13. Peripheral Interface Clock Timings

Parameter	Min	Max	Units
PCIClk input frequency (asynchronous mode)	Note 2	66	MHz
PCIClk period (asynchronous mode)	15	Note 2	ns
PCIClk input high time	40% of nominal period	60% of nominal period	ns
PCIClk input low time	40% of nominal period	60% of nominal period	ns
EMC0MDCIk output frequency	–	2.5	MHz
EMC0MDCIk period	400	–	ns
EMC0MDCIk output high time	160	–	ns
EMC0MDCIk output low time	160	–	ns
PHY0TxClk input frequency	2.5	25	MHz
PHY0TxClk period	40	400	ns
PHY0TxClk input high time	35% of nominal period	–	ns
PHY0TxClk input low time	35% of nominal period	–	ns
PHY0RxClk input frequency	2.5	25	MHz
PHY0RxClk period	40	400	ns
PHY0RxClk input high time	35% of nominal period	–	ns
PHY0RxClk input low time	35% of nominal period	–	ns
PerClk output frequency–133MHz	–	33.33	MHz
PerClk period–133MHz	30	–	ns
PerClk output frequency–200MHz	–	50	MHz
PerClk period–200MHz	20	–	ns
PerClk output frequency–266MHz)	–	66.66	MHz
PerClk period–266MHz	15	–	ns
PerClk output high time	45% of nominal period	55% of nominal period	ns
PerClk output low time	45% of nominal period	55% of nominal period	ns
UARTSerClk input frequency (Note 1)	–	1000/(2T _{OPB} + 2ns)	MHz
UARTSerClk period	2T _{OPB} + 2	–	ns
UARTSerClk input high time	T _{OPB} + 1	–	ns
UARTSerClk input low time	T _{OPB} + 1	–	ns
TmrClk input frequency–133MHz	–	33.33	MHz
TmrClk period–133MHz	30	–	ns
TmrClk input frequency–200MHz	–	50	MHz
TmrClk period–200MHz	20	–	ns
TmrClk input frequency–266MHz	–	66.66	MHz
TmrClk period–266MHz	15	–	ns
TmrClk input high time	40% of nominal period	60% of nominal period	ns
TmrClk input low time	40% of nominal period	60% of nominal period	ns
HDLCEXTxClk, HDLCEXRxCIk	0	8.192	MHz
HDLCMPTxClk, HDLCMPRxClk	–	2.048	MHz

Notes:

1. T_{OPB} is the period in ns of the OPB clock. The maximum OPB clock frequency is 33.33 MHz for 133MHz parts, 50 MHz for 200MHz parts, and 66.66MHz for 266MHz parts.
2. In asynchronous PCI mode the minimum PCIClk frequency is 1/8 the PLB Clock. Refer to the NPe405H User's Manual for more information.

INPUT SETUP AND HOLD WAVEFORM

Figure 5. Input Setup and Hold Waveform

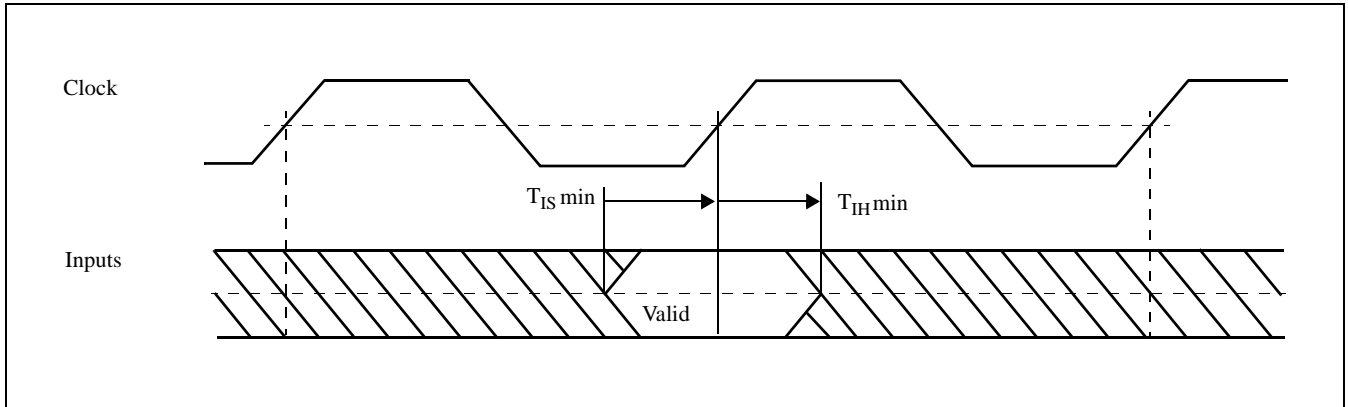

OUTPUT DELAY AND FLOAT TIMING WAVEFORM

Figure 6. Output Delay and Float Timing Waveform

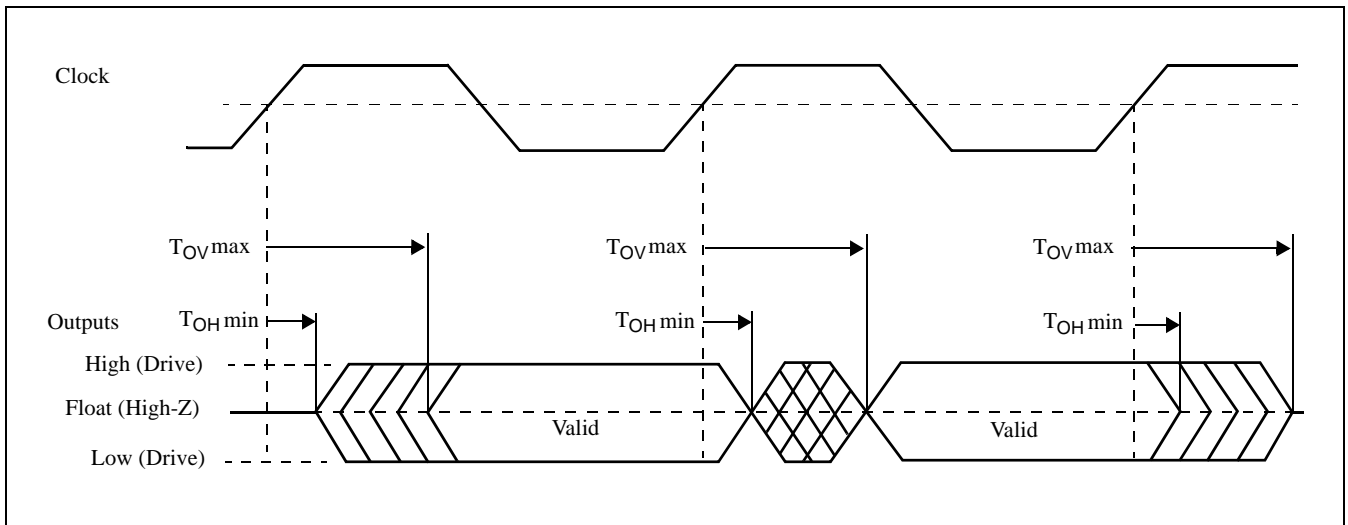

I/O SPECIFICATIONS—ALL

Table 14. I/O Specifications—All (Sheet 1 of 2)

Notes:

1. PCI timings are for asynchronous operation up to 66MHz. PCI output hold time requirement is 1 ns for 66MHz and 2 ns for 33MHz.

Signal	Input (ns)		Output (ns)		Output Current (mA)		Clock	Notes
	Setup Time (T _{IS} min)	Hold Time (T _{IH} min)	Valid Delay (T _{OV} max)	Hold Time (T _{OH} min)	I/O H (maximum)	I/O L (minimum)		
PCI Interface								
PCIAD00:31	3.0	0.0	6.0	2.0	0.5	1.5	PCIClk	6
PCIC0:3[BE3:0]	3.0	0.0	6.0	2.0	0.5	1.5	PCIClk	6
PCIClk	n/a	n/a	n/a	n/a	n/a	n/a		async
PCIDevSel	3.0	0.0	6.0	2.0	0.5	1.5	PCIClk	6
PCIFrame	3.0	0.0	6.0	2.0	0.5	1.5	PCIClk	6
PCIGnt0[Req] PCIGnt1:5	n/a	n/a	6.0	2.0	0.5	1.5	PCIClk	6
PCIIDSel	3.0	0.0	n/a	n/a	n/a	n/a	PCIClk	6
PCIINT[PerWE]	n/a	n/a	6.0	2.0	0.5	1.5	PCIClk	async
PCIIRDY	3.0	0.0	6.0	2.0	0.5	1.5	PCIClk	6
PCIParity	3.0	0.0	6.0	2.0	0.5	1.5	PCIClk	6
PCIPErr	3.0	0.0	6.0	2.0	0.5	1.5	PCIClk	6
PCIReq0[Gnt] PCIReq1:5	5.0	0.0	n/a	n/a	n/a	n/a	PCIClk	6
PCIReset	n/a	n/a	6.0	2.0	0.5	1.5	PCIClk	
PCISerr	3.0	0.0	6.0	2.0	0.5	1.5	PCIClk	
PCIStop	3.0	0.0	6.0	2.0	0.5	1.5	PCIClk	6
PCITRDY	3.0	0.0	6.0	2.0	0.5	1.5	PCIClk	6
Internal Peripheral Interface								
IIC_SCL	async	async	async	async	17	11		
IIC_SDA	async	async	async	async	17	11		
[UART0_CTS]	async	async	n/a	n/a	n/a	n/a		
[UART0_DCD]	async	async	n/a	n/a	n/a	n/a		
[UART0_DSR]	async	async	n/a	n/a	n/a	n/a		
[UART0_DTR]	n/a	n/a	async	async	12	8		
[UART0_RI]	async	async	n/a	n/a	n/a	n/a		
[UART0_RTS]	n/a	n/a	async	async	12	8		
UART0_Rx	async	async	n/a	n/a	n/a	n/a		
UART0_Tx	n/a	n/a	async	async	12	8		
[UART1_CTS]	async	async	n/a	n/a	n/a	n/a		
[UART1_DCD]	async	async	n/a	n/a	n/a	n/a		
[UART1_DSR]	async	async	n/a	n/a	n/a	n/a		
[UART1_DTR]	n/a	n/a	async	async	12	8		
[UART1_RI]	async	async	n/a	n/a	n/a	n/a		
[UART1_RTS]	n/a	n/a	async	async	12	8		
UART1_Rx	async	async	n/a	n/a	n/a	n/a		
UART1_Tx	n/a	n/a	async	async	12	8		
UARTSerCk	async	async	n/a	n/a	n/a	n/a		
Interrupts Interface								
[IRQ0:6]	async	async	n/a	n/a	n/a	n/a		

Table 14. I/O Specifications—All (Sheet 2 of 2)

Notes:

1. PCI timings are for asynchronous operation up to 66MHz. PCI output hold time requirement is 1 ns for 66MHz and 2 ns for 33MHz.

Signal	Input (ns)		Output (ns)		Output Current (mA)		Clock	Notes
	Setup Time (T _{IS} min)	Hold Time (T _{IH} min)	Valid Delay (T _{OV} max)	Hold Time (T _{OH} min)	I/O H (maximum)	I/O L (minimum)		
JTAG Interface								
TCK	async	async	n/a	n/a	n/a	n/a		
TDI	async	async	n/a	n/a	n/a	n/a		
TDO	n/a	n/a	async	async	12	8		
TMS	async	async	n/a	n/a	n/a	n/a		
TRST	async	async	n/a	n/a	n/a	n/a		
System Interface								
GPIO0:1	na	na	na	na	12	8		
Halt	async	async	n/a	n/a	n/a	n/a		
SysClk	n/a	n/a	n/a	n/a	n/a	n/a		
SysErr	n/a	n/a	8.6	3.7	12	8		
SysReset	n/a	n/a	7.4	3.3	12	8		
TestEn	dc	dc	n/a	n/a	n/a	n/a		
TmrClk	n/a	n/a	async	async	n/a	n/a		

I/O SPECIFICATIONS(A)—133 AND 200 MHZ

Table 15. I/O Specifications—133 and 200MHz (Sheet 1 of 3)

Notes:

1. Ethernet interface meets timing requirements as defined by IEEE 802.3 standard.
2. The SDRAM command interface is configurable through SDRAM0_TR[LDF] to provide a 2 to 4 cycle delay before the command is used by SDRAM. Output times in table are in cycle 1.
3. SDRAM I/O timings are specified relative to a MemClkOut terminated in a lumped 10pF load.
4. SDRAM interface hold times are guaranteed at the NPe405H package pin. System designers must use the NPe405H IBIS model (available from www.amcc.com) to ensure their clock distribution topology minimizes loading and reflections, and that the relative delays on clock wiring do not exceed the delays on other SDRAM signal wiring.
5. PerClk rising edge at package pin with a 10pF load trails the internal PLB clock by approximately 0.8ns.

Signal	Input (ns)		Output (ns)		Output Current (mA)		Clock	Notes
	Setup Time (T _{IS} min)	Hold Time (T _{IH} min)	Valid Delay (T _{OV} max)	Hold Time (T _{OH} min)	I/O H (maximum)	I/O L (minimum)		
Ethernet Interface								
EMC0MDCIk	n/a	n/a	n/a	n/a	12	8		1, async
EMC0MDIO	100	0.0	1 OPB clock period + 10ns	1 OPB Clock period	12	8	EMC0MDCIk	1
EMC0TxD0:3 [EMC0Tx0:1D0:1] [EMC0Tx0:3D]	n/a	n/a	12.4 7.0 5.0	4.1 2.3 1.5	12	8	PHYTX	1
EMC0TxEn [EMC0Tx0En] [EMC0Sync]	n/a	n/a	14.4 7.0 5.0	4.3 2.3 1.5	12	8	PHYTX	1
EMC0TxErr[EMC0Tx1En]	n/a	n/a	13.6[7.1]	4.0[2.4]	12	8	PHYTX	1
[EMC1TxD0][EMC1Tx2D0]	n/a	n/a	[15.0][8.2]	[4.8][2.5]	12	8		
[EMC1TxD1][EMC1Tx2D1]	n/a	n/a	[15.0][8.3]	[4.8][2.5]	12	8		
[EMC1TxD2][EMC1Tx3D0]	n/a	n/a	[15.1][8.2]	[4.8][2.5]	12	8		
[EMC1TxD3][EMC1Tx3D1]	n/a	n/a	[15.0][8.2]	[4.8][2.5]	12	8		
[EMC1TxEn][EMC1Tx2En]	n/a	n/a	[16.4][8.2]	[4.8][2.5]	12	8		
[EMC1TxErr][EMC1Tx3En]	n/a	n/a	[16.5][8.3]	[4.8][2.5]	12	8		
PHY0CoI[PHY0Rx1Er]	async[1.1]	async[0.9]	n/a	n/a	n/a	n/a		1
PHY0CrS[PHY0CrS0DV]	async[1.0]	async[1.3]	n/a	n/a	n/a	n/a		1
PHY0RxCk	n/a	n/a	n/a	n/a	n/a	n/a		1, async
PHY0Rx0:3 [PHY0Rx0:1D0:1] [PHY0Rx0:3D]	1.7 1.1 1.1	1.6 0.9 0.2	n/a	n/a	n/a	n/a	PHYRX	1
PHY0Rx0DV[PHY0CRS1DV]	1.5[1.0]	1.7[1.1]	n/a	n/a	n/a	n/a	PHYRX	1
PHY0RxErr[PHY0Rx0Er]	1.5[1.1]	1.6[1.0]	n/a	n/a	n/a	n/a	PHYRX	1
PHY0TxClk[PHY0RefClk]	n/a	n/a	n/a	n/a	n/a	n/a		1, async
[PHY1Rx0][PHY1Rx2D0]	[1.0][1.8]	[3.5][0.7]	n/a	n/a	n/a	n/a		
[PHY1Rx1][PHY1Rx2D1]	[1.3][2.2]	[3.0][0.3]	n/a	n/a	n/a	n/a		
[PHY1Rx2][PHY1Rx3D0]	[1.1][2.2]	[3.0][0.3]	n/a	n/a	n/a	n/a		
[PHY1Rx3][PHY1Rx3D1]	[1.0][1.9]	[3.3][0.7]	n/a	n/a	n/a	n/a		
[PHY1CoI][PHY1Rx3Er]	[1.4][2.2]	[2.2][0.3]	n/a	n/a	n/a	n/a		
[PHY1CrS][PHY1CrS2DV]	[1.3][2.1]	[2.6][0.8]	n/a	n/a	n/a	n/a		
[PHY1RxCk]	n/a	n/a	n/a	n/a	n/a	n/a		
[PHY1Rx0DV] [PHY1CrS3DV]	[1.0] [2.1]	[2.6] [0.0]	n/a	n/a	n/a	n/a		
[PHY1RxErr][PHY1Rx2Er]	[1.0][1.9]	[3.2][0.6]	n/a	n/a	n/a	n/a		
[PHY1TxClk]	n/a	n/a	n/a	n/a	n/a	n/a		
HDLCEX Interface								
HDLCEXRxCk	n/a	n/a	n/a	n/a	n/a	n/a		
HDLCEXRxDatA:B	27.7	1.4	n/a	n/a	n/a	n/a		
HDLCEXRxFs	24.2	0.6	n/a	n/a	n/a	n/a		

Table 15. I/O Specifications—133 and 200MHz (Sheet 2 of 3)

Notes:

1. Ethernet interface meets timing requirements as defined by IEEE 802.3 standard.
2. The SDRAM command interface is configurable through SDRAM0_TR[LDF] to provide a 2 to 4 cycle delay before the command is used by SDRAM. Output times in table are in cycle 1.
3. SDRAM I/O timings are specified relative to a MemClkOut terminated in a lumped 10pF load.
4. SDRAM interface hold times are guaranteed at the NPe405H package pin. System designers must use the NPe405H IBIS model (available from www.amcc.com) to ensure their clock distribution topology minimizes loading and reflections, and that the relative delays on clock wiring do not exceed the delays on other SDRAM signal wiring.
5. PerClk rising edge at package pin with a 10pF load trails the internal PLB clock by approximately 0.8ns.

Signal	Input (ns)		Output (ns)		Output Current (mA)		Clock	Notes
	Setup Time (T _{IS} min)	Hold Time (T _{IH} min)	Valid Delay (T _{OV} max)	Hold Time (T _{OH} min)	I/O H (maximum)	I/O L (minimum)		
HDLCEXTxClk	n/a	n/a	n/a	n/a	n/a	n/a		
HDLCEXTxDataA:B	n/a	n/a	10.5	3.3	12	8		
HDLCEXTxFS	24.4	0.7	n/a	n/a	n/a	n/a		
[HDLCEXTxEnA:B]	n/a	n/a	9.9	3.0	12	8		
HDLCMP Interface								
HDLCMPTxClk0:3	n/a	n/a	n/a	n/a	n/a	n/a		
[HDLCMPTxClk4:7]	n/a	n/a	n/a	n/a	n/a	n/a		
HDLCMPTxData0:3	n/a	n/a	9.3	3.0	12	8		
[HDLCMPTxData4]	n/a	n/a	[9.9]	[3.3]	12	8		
[HDLCMPTxData5]	n/a	n/a	[9.8]	[2.8]	12	8		
[HDLCMPTxData6]	n/a	n/a	[9.8]	[3.0]	12	8		
[HDLCMPTxData7]	n/a	n/a	[9.8]	[3.0]	12	8		
[HDLCMPTxEn0]	n/a	n/a	[10.0]	[2.9]	12	8		
[HDLCMPTxEn1]	n/a	n/a	[9.9]	[2.9]	12	8		
[HDLCMPTxEn2]	n/a	n/a	[9.4]	[2.9]	12	8		
[HDLCMPTxEn3]	n/a	n/a	[9.5]	[2.9]	12	8		
[HDLCMPTxEn4]	n/a	n/a	[9.9]	[3.3]	12	8		
[HDLCMPTxEn5]	n/a	n/a	[9.8]	[2.8]	12	8		
[HDLCMPTxEn6]	n/a	n/a	[9.8]	[3.0]	12	8		
[HDLCMPTxEn7]	n/a	n/a	[9.9]	[3.0]	12	8		
HDLCMPRxClk0:3	n/a	n/a	n/a	n/a	n/a	n/a		
[HDLCMPRxClk4:7]	n/a	n/a	n/a	n/a	n/a	n/a		
HDLCMPRxData0:3	22.8	0.5	n/a	n/a	n/a	n/a		
[HDLCMPRxData4]	[24.9]	[0.1]	n/a	n/a	n/a	n/a		
[HDLCMPRxData5]	[24.7]	[0.1]	n/a	n/a	n/a	n/a		
[HDLCMPRxData6]	[24.6]	[0.1]	n/a	n/a	n/a	n/a		
[HDLCMPRxData7]	[24.8]	[0.1]	n/a	n/a	n/a	n/a		
Trace Interface								
[TrcClk]	n/a	n/a	[12.2]	[2.5]	12	8		
[TS1E]	n/a	n/a	[7.2]	[2.0]	12	8		
[TS2E]	n/a	n/a	[7.2]	[2.0]	12	8		
[TS1O]	n/a	n/a	[7.2]	[2.0]	12	8		
[TS2O]	n/a	n/a	[7.2]	[2.0]	12	8		
[TS3:4]	n/a	n/a	[7.2]	[2.0]	12	8		

Table 15. I/O Specifications—133 and 200MHz (Sheet 3 of 3)

Notes:

1. Ethernet interface meets timing requirements as defined by IEEE 802.3 standard.
2. The SDRAM command interface is configurable through SDRAM0_TR[LDF] to provide a 2 to 4 cycle delay before the command is used by SDRAM. Output times in table are in cycle 1.
3. SDRAM I/O timings are specified relative to a MemClkOut terminated in a lumped 10pF load.
4. SDRAM interface hold times are guaranteed at the NPe405H package pin. System designers must use the NPe405H IBIS model (available from www.amcc.com) to ensure their clock distribution topology minimizes loading and reflections, and that the relative delays on clock wiring do not exceed the delays on other SDRAM signal wiring.
5. PerClk rising edge at package pin with a 10pF load trails the internal PLB clock by approximately 0.8ns.

Signal	Input (ns)		Output (ns)		Output Current (mA)		Clock	Notes
	Setup Time (T _{IS} min)	Hold Time (T _{IH} min)	Valid Delay (T _{OV} max)	Hold Time (T _{OH} min)	I/O H (maximum)	I/O L (minimum)		
SDRAM Interface								
BA1:0	n/a	n/a	7.1	1.1	19	12	MemClkOut	2, 3
BankSel3:0	n/a	n/a	5.2	0.5	19	12	MemClkOut	3
CAS	n/a	n/a	6.8	1.0	19	12	MemClkOut	2, 3
ClkEn0:1	n/a	n/a	4.5	0.5	40	25	MemClkOut	3
DQM0:3	n/a	n/a	5.3	0.5	19	12	MemClkOut	3
DQMCB	n/a	n/a	5.3	0.5	19	12	MemClkOut	3
ECC0:7	2.7	1.0	5.2	0.5	19	12	MemClkOut	3
MemAddr12:00	n/a	n/a	7.0	1.0	19	12	MemClkOut	2, 3
MemData00:31	2.8	1.0	5.2	0.5	19	12	MemClkOut	3
RAS	n/a	n/a	6.7	0.9	19	12	MemClkOut	2, 3
WE	n/a	n/a	5.5	1.5	19	12	MemClkOut	2, 3
External Slave Peripheral Bus Interface								
[DMAReq0:3]	[4.7]	[0.0]	n/a	n/a	n/a	n/a	PerClk	
[DMAAck0:3]	n/a	n/a	[8.5]	[1.0]	12	8	PerClk	
[EOT0:3/TC0:3]	[4.5]	[0.0]	[8.6]	[1.0]	12	8	PerClk	
PerAddr04:31	3.0	1.0	8.5	1.0	17	11	PerClk	
PerBLast	4.2	0.0	7.1	1.2	12	8	PerClk	
PerCS0	n/a	n/a	8.7	1.0	12	8	PerClk	
[PerCS1:7]	n/a	n/a	[8.7]	[1.0]	12	8	PerClk	
PerData00:31	5.7	1.0	9.5	1.3	17	11	PerClk	
PerOE	n/a	n/a	7.5	1.3	12	8	PerClk	
PerPar0:3	3.4	0.0	8.9	1.1	17	11	PerClk	
PerR/W	4.5	0.0	7.5	1.2	12	8	PerClk	
PerReady	7.6	0.0	n/a	n/a	n/a	n/a	PerClk	
PerWBE0:3	3.0	0.0	7.7	1.3	12	8	PerClk	
PerClk	n/a	n/a	-0.6	-0.7	17	11	PLB Clk	5
PerErr	2.9	0.0	n/a	n/a	n/a	n/a	PerClk	
External Master Peripheral Bus Interface								
BusReq	n/a	n/a	6.8	1.2	12	8	PerClk	
ExtAck	n/a	n/a	6.9	1.2	12	8	PerClk	
ExtReq	4.5	0.0	n/a	n/a	n/a	n/a	PerClk	
ExtReset	n/a	n/a	8.0	0.0	19	12	PerClk	
HoldAck	n/a	n/a	7.3	1.4	12	8	PerClk	
HoldPri	2.9	0.0	n/a	n/a	n/a	n/a	PerClk	
HoldReq	4.0	0.0	n/a	n/a	n/a	n/a	PerClk	
IIC EEPROM Controller								
IECSCL	async	async	async	async	17	11		
IECSDA	async	async	async	async	17	11		

I/O SPECIFICATIONS(A)—266 MHZ

Table 16. I/O Specifications—266MHz (Sheet 1 of 3)

Notes:

1. Ethernet interface meets timing requirements as defined by IEEE 802.3 standard.
2. The SDRAM command interface is configurable through SDRAM0_TR[LDF] to provide a 2 to 4 cycle delay before the command is used by SDRAM. Output times in table are in cycle 1.
3. SDRAM I/O timings are specified relative to a MemClkOut terminated in a lumped 10pF load.
4. SDRAM interface hold times are guaranteed at the NPe405H package pin. System designers must use the NPe405H IBIS model (available from www.amcc.com) to ensure their clock distribution topology minimizes loading and reflections, and that the relative delays on clock wiring do not exceed the delays on other SDRAM signal wiring.
5. PerClk rising edge at package pin with a 10pF load trails the internal PLB clock by approximately 0.8ns.

Signal	Input (ns)		Output (ns)		Output Current (mA)		Clock	Notes
	Setup Time (T _{IS} min)	Hold Time (T _{IH} min)	Valid Delay (T _{OV} max)	Hold Time (T _{OH} min)	I/O H (maximum)	I/O L (minimum)		
Ethernet Interface								
EMC0MDClk	n/a	n/a	n/a	n/a	12	8		1, async
EMC0MDIO	100	0.0	1 OPB clock period +10ns	1 OPB clock period	12	8	EMC0MDClk	1
EMC0TxD0:3 [EMC0Tx0:1D0:1] [EMC0Tx0:3D]	n/a	n/a	9.0 [5.3] [4.6]	4.1 [2.3] [1.5]	12	8	PHYTX	1
EMC0TxEn [EMC0Tx0En] [EMC0Sync]	n/a	n/a	11.4 [5.2] [4.6]	4.3 [2.3] [1.5]	12	8	PHYTX	1
EMC0TxErr[EMC0Tx1En]	n/a	n/a	10.8[5.4]	4.0[2.3]	12	8	PHYTX	1
[EMC1TxD0][EMC1Tx2D0]	n/a	n/a	[11.3][6.5]	[4.8][2.5]	12	8		
[EMC1TxD1][EMC1Tx2D1]	n/a	n/a	[10.9][6.1]	[4.8][2.5]	12	8		
[EMC1TxD2][EMC1Tx3D0]	n/a	n/a	[10.9][6.1]	[4.8][2.5]	12	8		
[EMC1TxD3][EMC1Tx3D1]	n/a	n/a	[11.4][6.5]	[4.8][2.5]	12	8		
[EMC1TxEn][EMC1Tx2En]	n/a	n/a	[12.7][6.2]	[4.8][2.5]	12	8		
[EMC1TxErr][EMC1Tx3En]	n/a	n/a	[12.7][6.0]	[4.8][2.5]	12	8		
PHY0Col[PHY0Rx1Er]	async[1.0]	async[0.7]	n/a	n/a	n/a	n/a		1
PHY0CrS[PHY0CrS0DV]	async[1.0]	async[0.9]	n/a	n/a	n/a	n/a		1
PHY0RxClk	n/a	n/a	n/a	n/a	n/a	n/a		1, async
PHY0Rx0:3 [PHY0Rx0:1D0:1] [PHY0Rx0:3D]	1.7 [1.1] [1.1]	1.2 [0.7] [0.1]	n/a	n/a	n/a	n/a	PHYRX	1
PHY0Rx0DV[PHY0CRS1DV]	1.5[1.1]	1.2[0.8]	n/a	n/a	n/a	n/a	PHYRX	1
PHY0RxErr[PHY0Rx0Er]	1.5[1.1]	1.2[0.8]	n/a	n/a	n/a	n/a	PHYRX	1
PHY0TxClk[PHY0RefClk]	n/a	n/a	n/a	n/a	n/a	n/a		1, async
[PHY1Rx0][PHY1Rx2D0]	[1.0][1.5]	[2.6][0.5]	n/a	n/a	n/a	n/a		
[PHY1Rx0D1][PHY1Rx2D1]	[1.2][1.8]	[2.2][0.3]	n/a	n/a	n/a	n/a		
[PHY1Rx0D2][PHY1Rx3D0]	[1.1][1.8]	[2.2][0.3]	n/a	n/a	n/a	n/a		
[PHY1Rx0D3][PHY1Rx3D1]	[0.9][1.5]	[2.5][0.5]	n/a	n/a	n/a	n/a		
[PHY1Col][PHY1Rx3Er]	[1.4][2.0]	[1.5][0.2]	n/a	n/a	n/a	n/a		
[PHY1CrS][PHY1CrS2DV]	[1.3][1.9]	[1.8][0.5]	n/a	n/a	n/a	n/a		
[PHY1RxClk]	n/a	n/a	n/a	n/a	n/a	n/a		
[PHY1Rx0DV] [PHY1CrS3DV]	1.1 [1.8]	2.0 [0.1]	n/a	n/a	n/a	n/a		
[PHY1RxErr][PHY1Rx2Er]	[1.0][1.6]	[2.4][0.4]	n/a	n/a	n/a	n/a		
[PHY1TxClk]	n/a	n/a	n/a	n/a	n/a	n/a		
HDLCEX Interface								
HDLCEXRxCik	n/a	n/a	n/a	n/a	n/a	n/a		
HDLCEXRxDatA:B	25.6	1.1	n/a	n/a	n/a	n/a		
HDLCEXRxFs	24.2	0.5	n/a	n/a	n/a	n/a		

Table 16. I/O Specifications—266MHz (Sheet 2 of 3)

Notes:

1. Ethernet interface meets timing requirements as defined by IEEE 802.3 standard.
2. The SDRAM command interface is configurable through SDRAM0_TR[LDF] to provide a 2 to 4 cycle delay before the command is used by SDRAM. Output times in table are in cycle 1.
3. SDRAM I/O timings are specified relative to a MemClkOut terminated in a lumped 10pF load.
4. SDRAM interface hold times are guaranteed at the NPe405H package pin. System designers must use the NPe405H IBIS model (available from www.amcc.com) to ensure their clock distribution topology minimizes loading and reflections, and that the relative delays on clock wiring do not exceed the delays on other SDRAM signal wiring.
5. PerClk rising edge at package pin with a 10pF load trails the internal PLB clock by approximately 0.8ns.

Signal	Input (ns)		Output (ns)		Output Current (mA)		Clock	Notes
	Setup Time (T _{IS} min)	Hold Time (T _{IH} min)	Valid Delay (T _{OV} max)	Hold Time (T _{OH} min)	I/O H (maximum)	I/O L (minimum)		
HDLCEXTxCIk	n/a	n/a	n/a	n/a	n/a	n/a		
HDLCEXTxDataA:B	n/a	n/a	7.2	3.1	12	8		
HDLCEXTxFS	24.3	0.5	n/a	n/a	n/a	n/a		
[HDLCEXTxEnA:B]	n/a	n/a	[7.4]	[3.2]	12	8		
HDLCMP Interface								
HDLCMPTxCIk0:3	n/a	n/a	n/a	n/a	n/a	n/a		
[HDLCMPTxCIk4:7]	n/a	n/a	n/a	n/a	n/a	n/a		
HDLCMPTxData0:3	n/a	n/a	7.3	3.1	12	8		
[HDLCMPTxData4]	n/a	n/a	[7.5]	[3.2]	12	8		
[HDLCMPTxData5]	n/a	n/a	[7.4]	[2.9]	12	8		
[HDLCMPTxData6]	n/a	n/a	[7.3]	[3.0]	12	8		
[HDLCMPTxData7]	n/a	n/a	[7.4]	[3.0]	12	8		
[HDLCMPTxEn0:3]	n/a	n/a	[7.4]	[2.8]	12	8		
[HDLCMPTxEn4]	n/a	n/a	[7.5]	[3.2]	12	8		
[HDLCMPTxEn5]	n/a	n/a	[7.8]	[3.1]	12	8		
[HDLCMPTxEn6]	n/a	n/a	[7.4]	[3.0]	12	8		
[HDLCMPTxEn7]	n/a	n/a	[7.4]	[3.0]	12	8		
HDLCMPRxCIk0:3	n/a	n/a	n/a	n/a	n/a	n/a		
[HDLCMPRxCIk4:7]	n/a	n/a	n/a	n/a	n/a	n/a		
HDLCMPRxData0:3	21.1	0.4	n/a	n/a	n/a	n/a		
[HDLCMPRxData4]	[24.8]	[0.1]	n/a	n/a	n/a	n/a		
[HDLCMPRxData5]	[24.7]	[0.1]	n/a	n/a	n/a	n/a		
[HDLCMPRxData6]	[24.7]	[0.1]	n/a	n/a	n/a	n/a		
[HDLCMPRxData7]	[24.8]	[0.1]	n/a	n/a	n/a	n/a		
Trace Interface								
[TrcClk]	n/a	n/a	[9.5]	[2.5]	12	8		
[TS1E]	n/a	n/a	[5.9]	[2.0]	12	8		
[TS2E]	n/a	n/a	[5.9]	[2.0]	12	8		
[TS1O]	n/a	n/a	[5.9]	[2.0]	12	8		
[TS2O]	n/a	n/a	[5.9]	[2.0]	12	8		
[TS3:6]	n/a	n/a	[5.9]	[2.0]	12	8		

Table 16. I/O Specifications—266MHz (Sheet 3 of 3)

Notes:

1. Ethernet interface meets timing requirements as defined by IEEE 802.3 standard.
2. The SDRAM command interface is configurable through SDRAM0_TR[LDF] to provide a 2 to 4 cycle delay before the command is used by SDRAM. Output times in table are in cycle 1.
3. SDRAM I/O timings are specified relative to a MemClkOut terminated in a lumped 10pF load.
4. SDRAM interface hold times are guaranteed at the NPe405H package pin. System designers must use the NPe405H IBIS model (available from www.amcc.com) to ensure their clock distribution topology minimizes loading and reflections, and that the relative delays on clock wiring do not exceed the delays on other SDRAM signal wiring.
5. PerClk rising edge at package pin with a 10pF load trails the internal PLB clock by approximately 0.8ns.

Signal	Input (ns)		Output (ns)		Output Current (mA)		Clock	Notes
	Setup Time (T _{IS} min)	Hold Time (T _{IH} min)	Valid Delay (T _{OV} max)	Hold Time (T _{OH} min)	I/O H (maximum)	I/O L (minimum)		
SDRAM Interface								
BA1:0	n/a	n/a	6.0	1.8	19	12	MemClkOut	2, 3
BankSel3:0	n/a	n/a	4.7	1.2	19	12	MemClkOut	3
CAS	n/a	n/a	5.7	1.7	19	12	MemClkOut	2, 3
ClkEn0:1	n/a	n/a	4.2	1.2	40	25	MemClkOut	3
DQM0:3	n/a	n/a	4.7	1.2	19	12	MemClkOut	3
DQMCB	n/a	n/a	4.7	1.2	19	12	MemClkOut	3
ECC0:7	1.6	1.0	4.8	1.2	19	12	MemClkOut	3
MemAddr12:00	n/a	n/a	6.0	1.7	19	12	MemClkOut	2, 3
MemData00:31	1.6	1.0	4.8	1.2	19	12	MemClkOut	3
RAS	n/a	n/a	5.7	1.6	19	12	MemClkOut	2, 3
WE	n/a	n/a	6.2	2.2	19	12	MemClkOut	2, 3
External Slave Peripheral Bus Interface								
[DMAReq0:3]	[3.8]	[0.0]	n/a	n/a	n/a	n/a	PerClk	
[DMAAck0:3]	n/a	n/a	[6.1]	[1.0]	12	8	PerClk	
[EOT0:3/TC0:3]	[3.5]	[0.0]	[6.4]	[1.0]	12	8	PerClk	
PerAddr04:31	2.4	0.0	6.6	1.0	17	11	PerClk	
PerBLast	3.0	0.0	5.3	1.2	12	8	PerClk	
PerCS0	n/a	n/a	5.3	1.2	12	8	PerClk	
[PerCS1:7]	n/a	n/a	[7.1]	[1.0]	12	8	PerClk	
PerData00:31	4.4	1.0	7.2	1.2	17	11	PerClk	
PerOE	n/a	n/a	7.5	1.3	12	8	PerClk	
PerPar0:3	2.7	0.0	6.9	1.1	17	11	PerClk	
PerR/W	3.5	0.0	5.6	1.2	12	8	PerClk	
PerReady	5.8	0.0	n/a	n/a	n/a	n/a	PerClk	
PerWBE0:3	2.4	0.0	5.7	1.3	12	8	PerClk	
PerClk	n/a	n/a	0.0	0.7	17	11	PLB Clk	5
PerErr	2.3	0.0	n/a	n/a	n/a	n/a	PerClk	
External Master Peripheral Bus Interface								
BusReq	n/a	n/a	5.0	1.2	12	8	PerClk	
ExtAck	n/a	n/a	5.1	1.2	12	8	PerClk	
ExtReq	3.5	0.0	n/a	n/a	n/a	n/a	PerClk	
ExtReset	n/a	n/a	8.0	0.0	19	12	PerClk	
HoldAck	n/a	n/a	5.4	1.4	12	8	PerClk	
HoldPri	2.3	0.0	n/a	n/a	n/a	n/a	PerClk	
HoldReq	3.2	0.0	n/a	n/a	n/a	n/a	PerClk	
IIC EEPROM Controller								
IECSCL	async	async	async	async	17	11		
IECSDA	async	async	async	async	17	11		

INITIALIZATION

The following describes the method by which initial chip settings are established when a system reset occurs.

Strapping

While the SysReset input pin is low (system reset), the state of certain I/O pins is read to enable default initial conditions prior to NPe405H start-up. The actual capture instant is the nearest SysClk edge before the deassertion of reset. These pins must be strapped using external pull-up (logical 1) or pull-down (logical 0) resistors to select the desired default conditions. The recommended pull-up is 3kΩ to +3.3V or 10kΩ to +5V, the recommended pull-down is 1kΩ to GND. These pins are used for strap functions only during reset. They are used for other signals during normal operation. The following table lists the strapping pins along with their functions and strapping options.

STRAPPING PIN ASSIGNMENTS

Table 17. Strapping Pin Assignments

Function	Option	Ball Strapping	
		AJ33 (UART1_Tx)	H01 (HoldAck)
SEPROMPresent – Serial EEPROM connection to the IIC interface	Not connected	0	
	Connected	1	
			H02 (ExtAck)
When SEPROMPresent = 1, these pins set the high-order two bits of the EEPROM base address.	High order EEPROM base address bits	x	x
When SEPROMPresent = 0, these pins indicated the width of the boot ROM.	8 bits	0	0
	16 bits	0	1
	32 bits	1	0
	reserved	1	1

EEPROM

During reset, configuration values other than those obtained from the strapping pins can be read from a serial EEPROM connected to the IIC port. The association of bits in the EEPROM with the configuration values and their default values are covered in detail in the *PowerNP NPe405H Network Processor User’s Manual*.

Caution: If SEPROMPresent is strapped to 1, and the EEPROM is not connected or is defective, the NPe405H will not boot up.

DOCUMENT REVISION HISTORY

Revision	Date	Description
1.02	11/16/07	Page 5, Updated Ordering, PVR, and JTAG Information Table, also included update to footnote. Page 5, Updated AMCC Part Number Key Block.
1.01	04/18/07	Updated SDRAM and MDIO timing in Tables 15 and 16.
1.00	07/29/04	Initial Release



Applied Micro Circuits Corporation
6310 Sequence Dr., San Diego, CA 92121

Main Phone: (858) 450-9333 — Technical Support Phone: (858) 535-6517 — (800) 840-6055

<http://www.amcc.com> (support@amcc.com)

AMCC reserves the right to make changes to its products, its datasheets, or related documentation, without notice and warrants its products solely pursuant to its terms and conditions of sale, only to substantially comply with the latest available datasheet. Please consult AMCC's Term and Conditions of Sale for its warranties and other terms, conditions and limitations. AMCC may discontinue any semiconductor product or service without notice, and advises its customers to obtain the latest version of relevant information to verify, before placing orders, that the information is current. AMCC does not assume any liability arising out of the application or use of any product or circuit described herein, neither does it convey any license under its patent rights nor the rights of others. AMCC reserves the right to ship devices of higher grade in place of those of lower grade.

AMCC SEMICONDUCTOR PRODUCTS ARE NOT DESIGNED, INTENDED, AUTHORIZED, OR WARRANTED TO BE SUITABLE FOR USE IN LIFE-SUPPORT APPLICATIONS, DEVICES OR SYSTEMS OR OTHER CRITICAL APPLICATIONS.

AMCC is a registered Trademark of Applied Micro Circuits Corporation. Copyright © 2007 Applied Micro Circuits Corporation.