

Description

The ACE2302 is the N-Channel logic enhancement mode power field effect transistors are produced using high cell density, DMOS trench technology.

This high density process is especially tailored to minimize on-state resistance.

These devices are particularly suited for low voltage application such as cellular phone and notebook computer power management and Battery powered circuits, and low in-line power loss are needed in a very small outline surface mount package.

Features

- 20V/3.6A, $R_{DS(ON)}=80m\Omega@V_{GS}=4.5V$
- 20V/3.1A, $R_{DS(ON)}=95m\Omega@V_{GS}=2.5V$
- Super high density cell design for extremely low $R_{DS(ON)}$
- Exceptional on-resistance and maximum DC current capability

Application

- Power Management in Note book
- Portable Equipment
- Battery Powered System
- DC/DC Converter
- Load Switch
- DSC
- LCD Display inverter

Absolute Maximum Ratings

Parameter	Symbol	Max	Unit
Drain-Source Voltage	V_{DSS}	20	V
Gate-Source Voltage	V_{GSS}	± 20	V
Continuous Drain Current ($T_J=150^\circ C$)	I_D	$T_A=25^\circ C$	3.2
		$T_A=70^\circ C$	2.6
Pulsed Drain Current	I_{DM}	10	A
Continuous Source Current (Diode Conduction)	I_S	1.6	A
Power Dissipation	P_D	$T_A=25^\circ C$	1.25
		$T_A=70^\circ C$	0.8
Operating Junction Temperature	T_J	150	$^\circ C$
Storage Temperature Range	T_{STG}	-55/150	$^\circ C$
Thermal Resistance-Junction to Ambient	$R_{\theta JA}$	100	$^\circ C/W$

Packaging Type

SOT-23-3

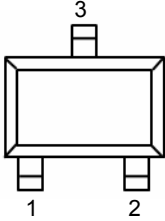

Pin	Symbol	Description
1	G	Gate
2	S	Source
3	D	Drain

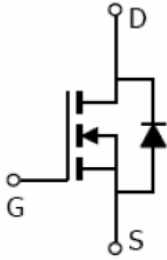

Ordering information

Selection Guide

ACE2302 XX + H

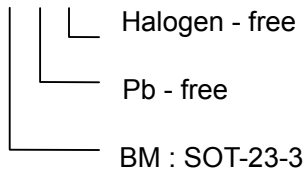

Electrical Characteristics

$T_A=25^{\circ}\text{C}$, unless otherwise noted

Parameter	Symbol	Conditions	Min.	Typ.	Max.	Unit
Static						
Drain-Source Breakdown Voltage	$V_{(BR)DSS}$	$V_{GS}=0V, I_D=250\ \mu A$	20			V
Gate Threshold Voltage	$V_{GS(th)}$	$V_D=V_{GS}, I_D=250\ \mu A$	0.45		1.2	
Gate Leakage Current	I_{GSS}	$V_{DS}=0V, V_{GS}=\pm 12V$			± 100	nA
Zero Gate Voltage Drain Current	I_{DSS}	$V_{DS}=20V, V_{GS}=0V$			1	uA
		$V_{DS}=24V, V_{GS}=0V, T_J=55^{\circ}\text{C}$			10	
On-State Drain Current	$I_{D(ON)}$	$V_{DS} \geq 5V, V_{GS}=4.5V$	6			A
		$V_{DS} \geq 5V, V_{GS}=2.5V$	4			
Drain-Source On-Resistance	$R_{DS(ON)}$	$V_{GS}=4.5V, I_D=3.6A$		0.050	0.080	Ω
		$V_{GS}=2.5V, I_D=3.1A$		0.070	0.095	
Forward Transconductance	g_{fs}	$V_{DS}=5V, I_D=3.6A$		10		S

VER 1.2 2

Diode Forward Voltage	V_{SD}	$I_S=1.6A, V_{GS}=0V$	0.85	1.2	V
Dynamic					
Total Gate Charge	Q_g	$V_{DS}=10V, V_{GS}=4.5V, I_D=3.6A$	5.4	10	nC
Gate-Source Charge	Q_{gs}		0.65		
Gate-Drain Charge	Q_{gd}		1.4		
Input Capacitance	C_{iss}	$V_{DS}=10V, V_{GS}=0V, f=1MHz$	340		pF
Output Capacitance	C_{oss}		115		
Reverse Transfer Capacitance	C_{rss}		33		
Turn-On Time	$t_d(on)$	$V_{DD}=10V, R_L=5.5\Omega, I_D=3.6A, V_{GEN}=4.5V, R_G=6\Omega$	12	25	nS
	t_r		36	60	
Turn-Off Time	$t_d(off)$		34	60	
	t_f		10	25	

Typical Performance Characteristics

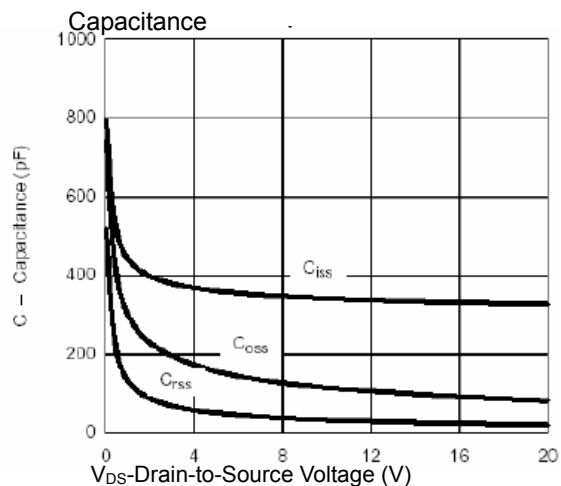
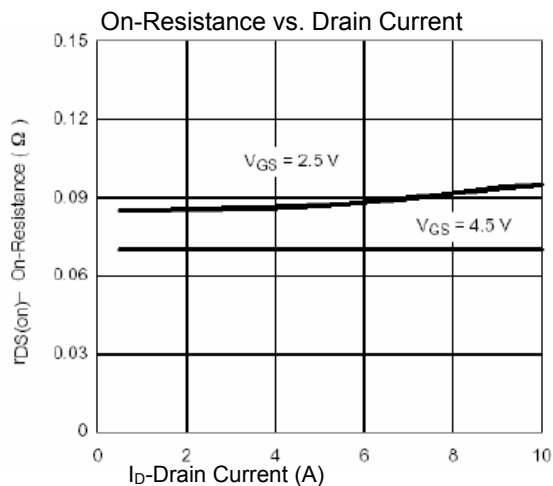
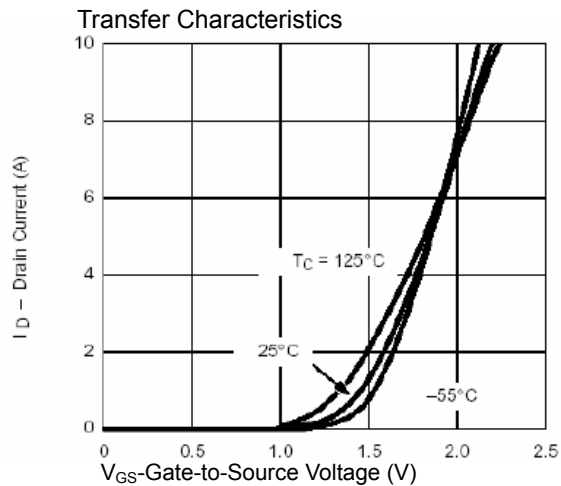
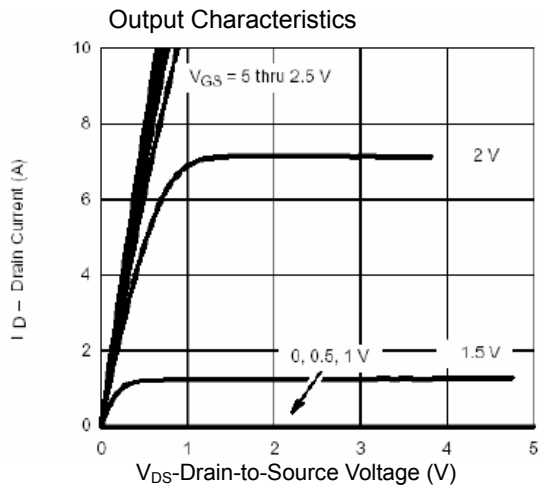

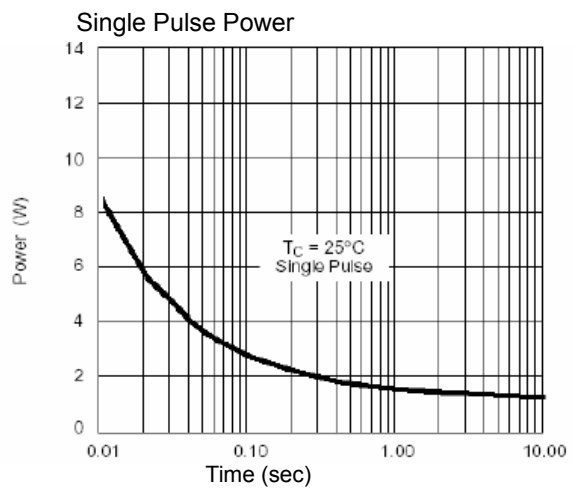
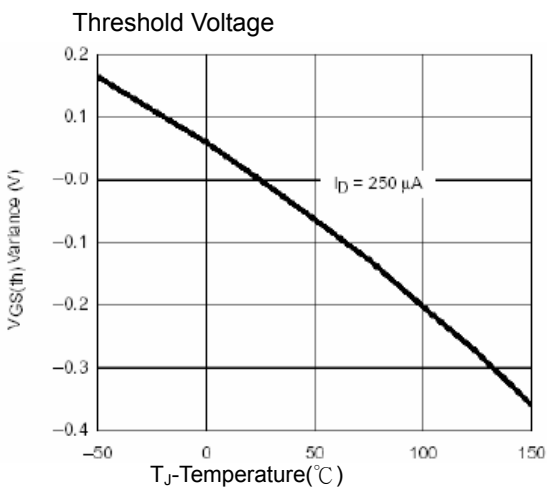
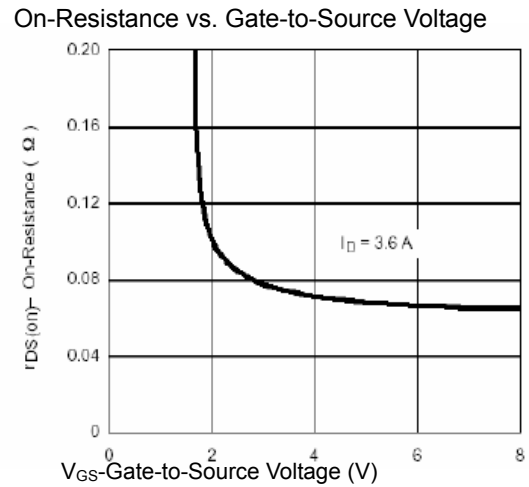
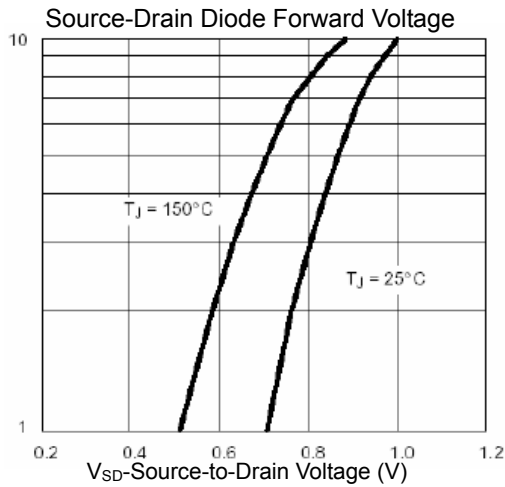
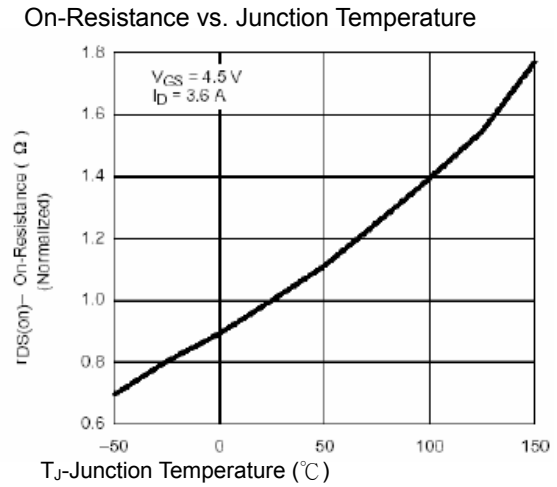
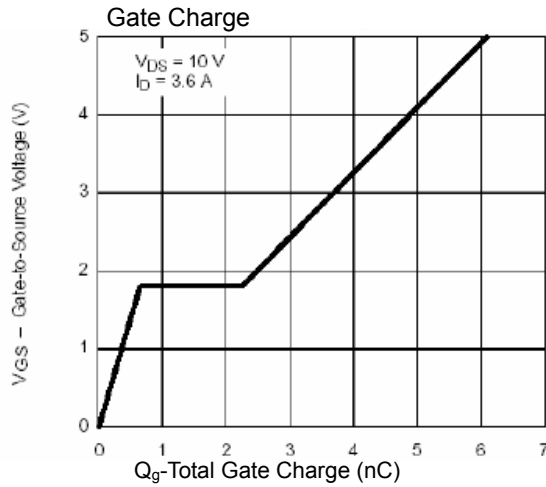

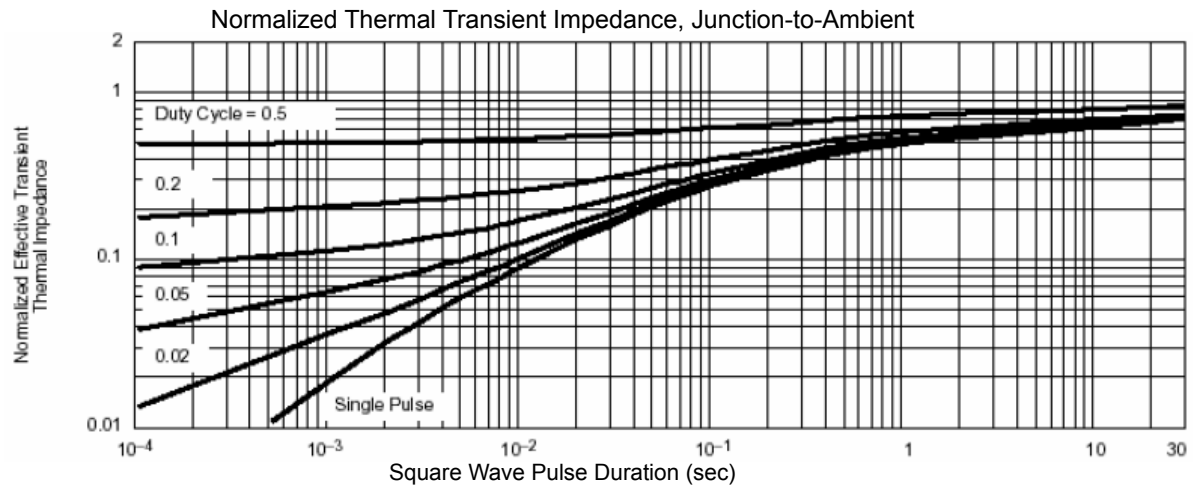

Packing Information

SOT-23-3

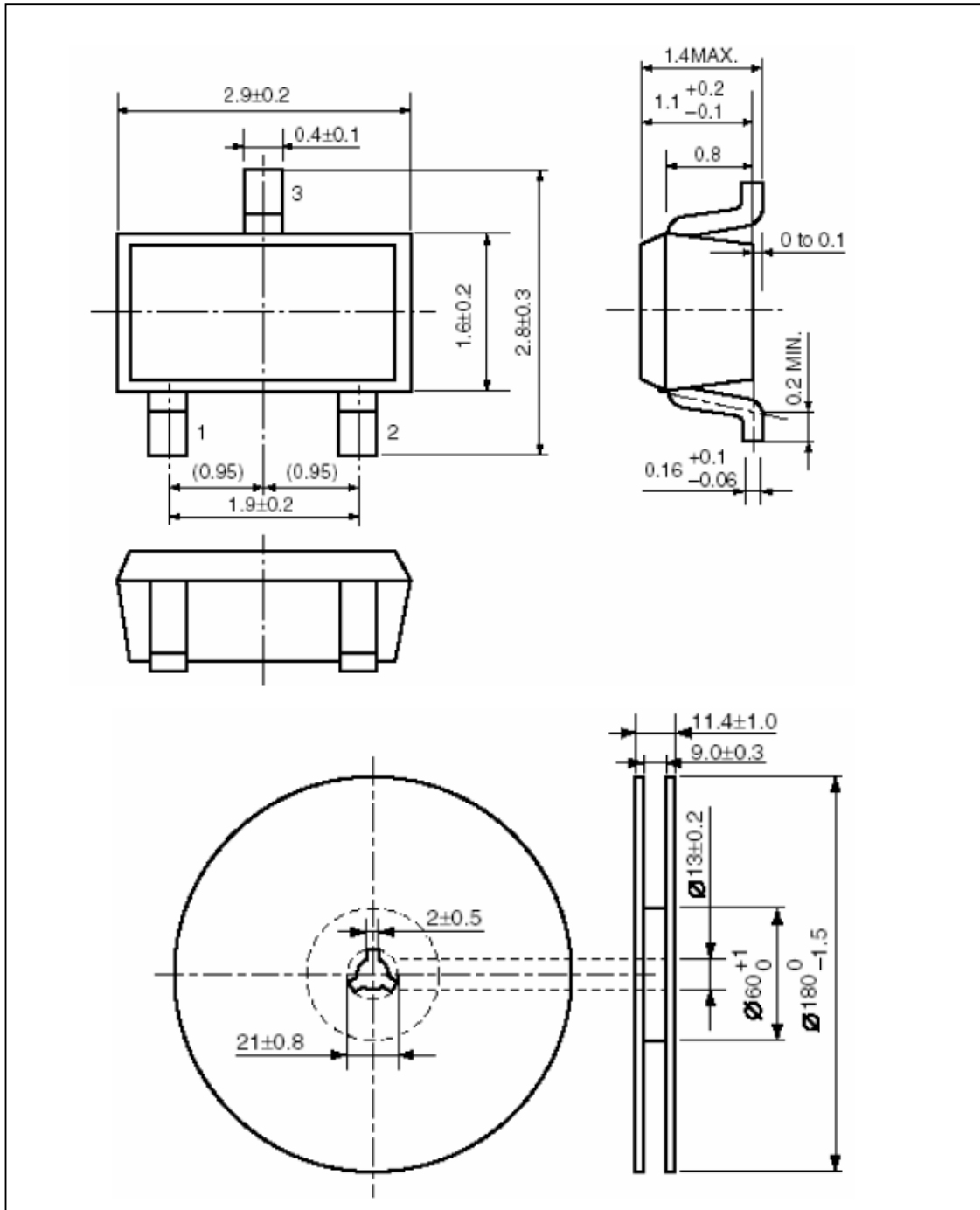

Notes

ACE does not assume any responsibility for use as critical components in life support devices or systems without the express written approval of the president and general counsel of ACE Electronics Co., LTD. As sued herein:

1. Life support devices or systems are devices or systems which, (a) are intended for surgical implant into the body, or (b) support or sustain life, and whose failure to perform when properly used in accordance with instructions for use provided in the labeling, can be reasonably expected to result in a significant injury to the user.
2. A critical component is any component of a life support device or system whose failure to perform can be reasonably expected to cause the failure of the life support device or system, or to affect its safety or effectiveness.

ACE Technology Co., LTD.
<http://www.ace-ele.com/>