

Features

- Low Noise Figure
- High Small Signal Gain
- Single +2.7V Operation
- Power-up Control
- 50Ω Output
- Unconditionally Stable
- Ultra Compact PLLP6 Package
- Pb-free, RoHS Compliant, Green

Benefits

- Low Power Consumption < 10 mW
- Very Small, PLLP6 Package (1.6 mm × 2.0 mm)
- Few External Components

1. Description

The ATR0610 is a GPS low-noise amplifier IC designed for GPS applications. The part uses Atmel's SiGe1 SiGe technology and is optimized for high linearity, low-noise figure, low BOM and low power consumption. The part features an integrated 50Ω output match and is prematched at the input. Due to internal supply blocking, the BOM is minimized. Together with the small footprint of 1.6 mm × 2.0 mm, the LNA allows for a very compact GPS receiver design.

Figure 1-1. Block Diagram

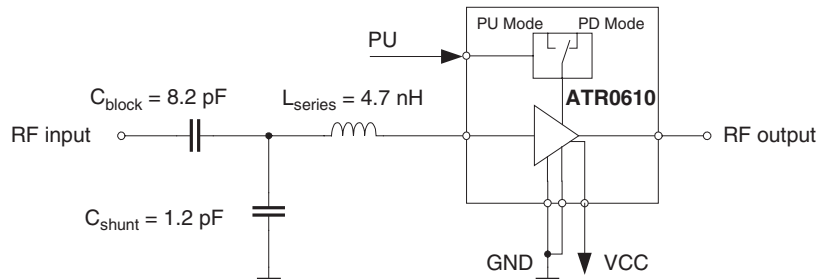

2.7-V GPS Low-noise Amplifier

ATR0610

2. Pin Configuration

Figure 2-1. Pinning PLLP6 (Not Scaled)

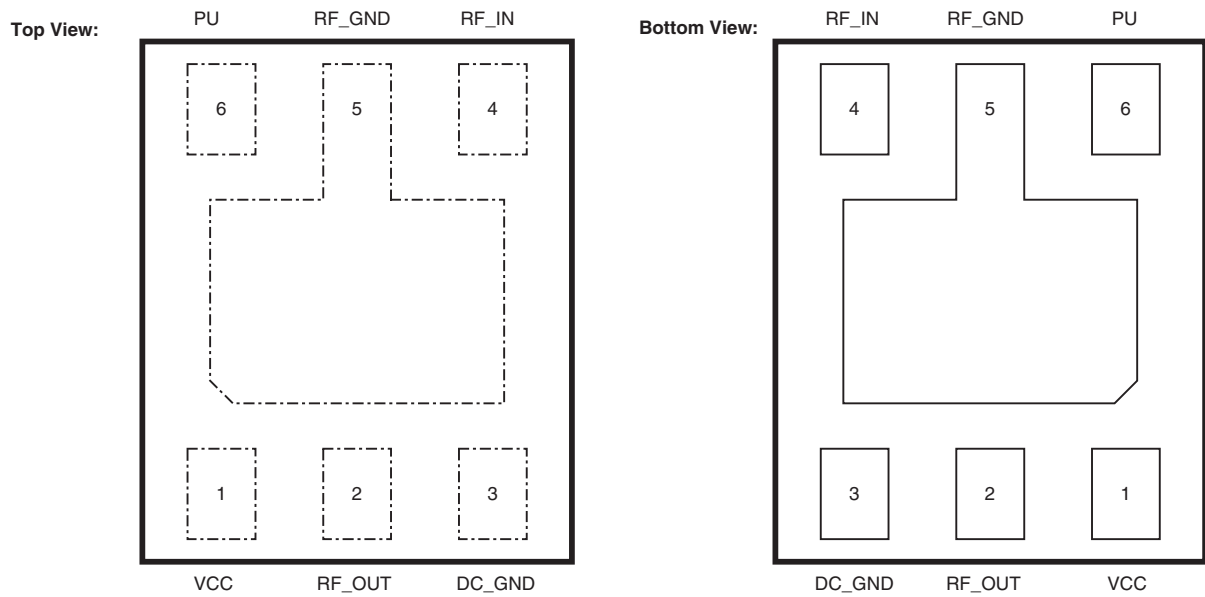

Table 2-1. Pin Description

Pin	Symbol	Type	Function
1	VCC	Supply	Supply voltage
2	RF_OUT	Output	Signal output
3	DC_GND	Supply	Ground
4	RF_IN	Input	Input for received signal
5	RF_GND	Supply	Ground for RF stage
6	PU	Input	Power up

3. Absolute Maximum Ratings

Parameters	Symbol	Value	Unit
Supply voltage	V_{CC}	-0.3 to +3.7	V
Power-up voltage	V_{PU}	-0.3 to +3.7	V
Input power	P_{in}	-5	dBm
Operating temperature	T_{op}	-40 to +85	°C
Storage temperature	T_{stg}	-55 to +125	°C

Electrostatic sensitive device.
Observe precautions for handling.



4. Thermal Resistance

Parameters	Symbol	Value	Unit
Thermal resistance	R_{th}	100	K/W

5. Electrical Characteristics

$V_{CC} = 2.7V$, $V_{PU} = 1.8V$, $f = 1575\text{ MHz}$, $T_{amb} = 25^\circ\text{C}$, $Z_{load} = 50\Omega$

Minimum/maximum limits are at +25°C ambient temperature, unless otherwise specified.

No.	Parameters	Test Conditions	Pin	Symbol	Min.	Typ.	Max.	Unit	Type*
1	Operating frequency		RF_IN	f		1575.42		MHz	D
2	Supply voltage		VCC	V_{CC}	2.7	3	3.3	V	C
3	Operating current	RF ON ($V_{PU} = 1.8V$)	VCC	I		3.3		mA	A
4	Power-down current	RF OFF ($V_{PU} = 0V$)	VCC	I_{PD}		0.2	1	µA	A
5	Small signal gain	(1)		G		16		dB	A
6	Minimum noise figure			NF_{min}		1.5		dB	C
7	Noise figure	(1)		NF		1.6		dB	C
8	Input referred 1 dB compression point	Caused by a DCS blocker at 1710 MHz ⁽¹⁾		Icp1		-9		dBm	C
9	Input 3 rd -order intercept point	f1 = 1750 MHz f2 = 1925 MHz ⁽¹⁾		IIP3		-1		dBm	C
10	Input 3 rd -order intercept point (inband)	f1 = 1575 MHz f2 = 1577 MHz ⁽¹⁾		$IIP3_{inb}$		-3		dBm	C
11	Input return loss	(1)		RL_{in}	10			dB	C
12	Output return loss	(1)		RL_{out}	10			dB	C
13	Reverse isolation	(1)		$1/ S_{12} ^2$		30		dB	C
14	Control voltage	Power-up mode	PU	$V_{PU,high}$	1.2	1.8	3.3	V	C
15	Control current	Power-up mode	PU	$I_{PU,high}$	0	10	50	µA	C
16	Control voltage	Power-down mode	PU	$V_{PU,low}$	0	0.2	0.4	V	C
17	Control current	Power-down mode	PU	$I_{PU,low}$			0.7	µA	C

*) Type means: A = 100% tested, B = 100% correlation tested, C = Characterized on samples, D = Design parameter

Note: 1. Using the proposed input matching (see [Figure 1-1 on page 1](#)) and the PCB layout shown in [Figure 7-1 on page 11](#).

6. Measurement Results of Typical Samples

$V_{CC} = 2.7V$, $V_{PU} = 1.8V$, $T_{amb} = 25^{\circ}C$, $Z_{LOAD} = 50\Omega$

6.1 Matched Device (see [Figure 1-1 on page 1](#))

Figure 6-1. Gain and Maximum Available Gain

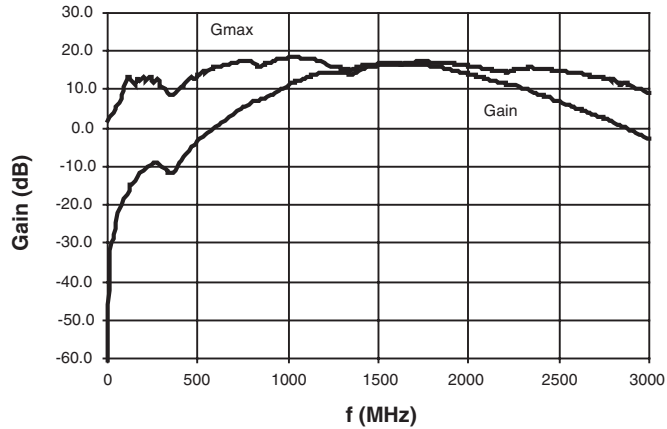

Figure 6-2. Input and Output Return Loss

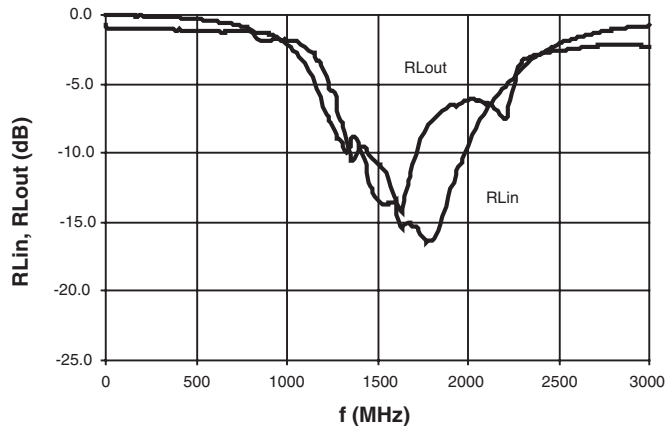

Figure 6-3. Reverse Transfer Function

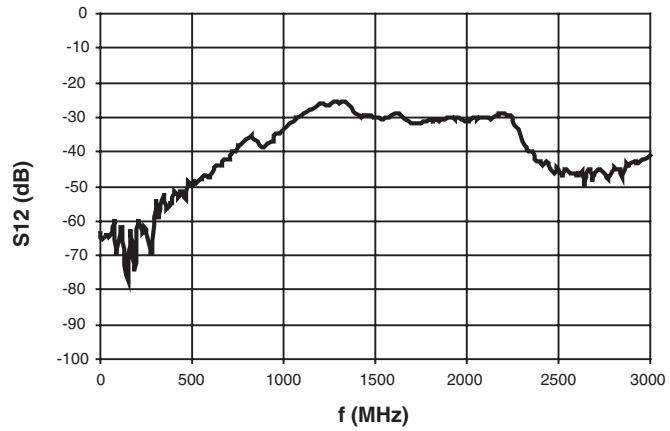

Figure 6-4. K Factor (→ Unconditional Stability)

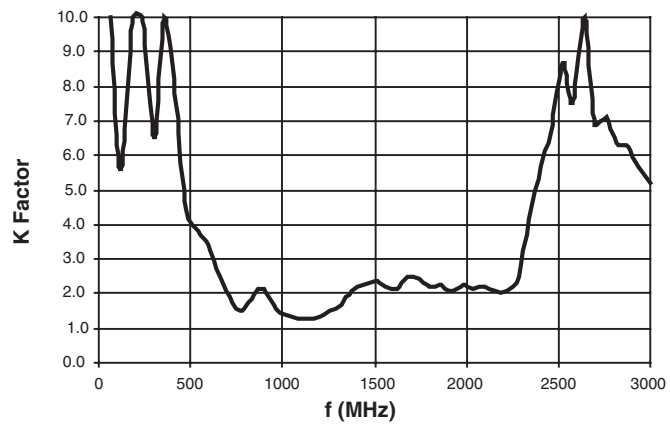

Table 6-1. Measured Scattering Parameters of Matched Device (Given as Linear Magnitude and Phase in Degree)

f/MHz	S ₁₁	∠(S ₁₁)	S ₂₁	∠(S ₂₁)	S ₁₂	∠(S ₁₂)	S ₂₂	∠(S ₂₂)	K Factor
60	0.897	-9.9	0.06	-96.1702	0.0006	19.5	0.998	-6.6	13.5
120	0.891	-25.6	0.17	-98.98544	0.0008	84.2	0.996	-17.4	5.5
180	0.886	-37.4	0.26	-113.4846	0.0002	173.8	0.991	-26.1	43.3
240	0.891	-49.4	0.34	-128.3148	0.0008	-86.0	0.987	-34.4	10.1
300	0.894	-61.9	0.32	-145.6032	0.0021	-137.8	0.981	-42.8	6.5
360	0.890	-74.3	0.26	-128.5304	0.0014	153.2	0.979	-51.4	12.3
420	0.879	-86.0	0.41	-113.438	0.0022	149.7	0.973	-60.1	7.4
480	0.876	-97.1	0.62	-117.7927	0.0037	147.3	0.965	-69.3	4.4
540	0.872	-108.2	0.83	-125.7797	0.0039	143.4	0.958	-78.0	3.8
600	0.869	-118.8	1.07	-135.3626	0.0043	142.5	0.948	-87.1	3.4
660	0.872	-129.8	1.34	-144.9783	0.0063	130.7	0.935	-96.9	2.5
720	0.874	-140.7	1.66	-155.2931	0.0101	127.3	0.920	-106.6	1.7
780	0.878	-153.0	2.04	-168.018	0.0144	108.8	0.893	-116.9	1.5
840	0.813	-165.3	2.30	177.8467	0.0152	73.6	0.863	-126.3	2.0
900	0.806	-172.6	2.64	169.357	0.0126	71.9	0.853	-137.2	2.1
960	0.813	176.5	3.17	157.1773	0.0185	79.4	0.817	-149.8	1.6
1020	0.809	164.4	3.78	143.6133	0.0237	67.9	0.767	-163.0	1.4
1080	0.785	150.1	4.34	128.2928	0.0318	51.1	0.693	-176.6	1.3
1140	0.732	135.5	4.93	111.4632	0.0399	35.3	0.598	168.3	1.3
1200	0.637	118.7	5.30	92.48291	0.0491	11.0	0.466	155.8	1.3
1260	0.522	107.6	5.32	76.71066	0.0494	-10.0	0.381	147.9	1.5
1320	0.378	98.0	5.24	63.20023	0.0517	-36.7	0.325	141.9	1.7
1380	0.311	108.3	5.33	56.22391	0.0385	-63.8	0.358	125.1	2.1
1440	0.325	97.5	6.14	41.04218	0.0326	-62.8	0.270	88.5	2.3
1500	0.287	88.9	6.51	25.58716	0.0307	-74.9	0.212	52.2	2.4
1560	0.257	73.3	6.77	8.313904	0.0320	-76.5	0.207	-1.0	2.2
1620	0.180	59.1	6.58	-8.583069	0.0355	-93.7	0.202	-46.0	2.1
1680	0.175	46.3	6.79	-22.98477	0.0281	-107.7	0.268	-62.3	2.5
1740	0.160	3.9	6.78	-40.46539	0.0263	-103.6	0.358	-81.5	2.4
1800	0.152	-43.9	6.33	-57.3143	0.0297	-112.5	0.411	-101.3	2.2
1860	0.187	-77.9	5.95	-73.04535	0.0288	-121.8	0.453	-116.8	2.2
1920	0.249	-104.8	5.58	-87.41135	0.0310	-132.7	0.471	-129.8	2.1
1980	0.314	-122.7	5.15	-100.7899	0.0285	-142.7	0.487	-139.2	2.3
2040	0.389	-137.6	4.71	-114.63	0.0307	-154.3	0.492	-150.3	2.1
2100	0.450	-151.0	4.33	-127.6309	0.0305	-171.1	0.476	-156.8	2.2
2160	0.514	-162.2	3.99	-138.8933	0.0328	175.1	0.452	-162.0	2.1
2220	0.564	-172.4	3.71	-151.1952	0.0333	148.3	0.443	-152.8	2.1
2280	0.621	179.3	3.45	-166.5967	0.0205	110.4	0.645	-158.2	2.5
2340	0.678	169.7	3.08	-178.6954	0.0100	118.3	0.708	-173.7	4.1
2400	0.722	160.6	2.66	170.4748	0.0071	129.9	0.722	175.9	5.7
2460	0.762	152.2	2.39	158.4146	0.0056	136.8	0.738	167.1	6.7

Table 6-1. Measured Scattering Parameters of Matched Device (Given as Linear Magnitude and Phase in Degree)

f/MHz	S ₁₁	∠(S ₁₁)	S ₂₁	∠(S ₂₁)	S ₁₂	∠(S ₁₂)	S ₂₂	∠(S ₂₂)	K Factor
2520	0.793	144.0	2.14	148.5269	0.0042	129.5	0.742	158.8	8.7
2580	0.821	136.5	1.87	139.0457	0.0047	134.1	0.750	151.3	7.5
2640	0.839	129.4	1.65	127.6694	0.0032	158.1	0.762	143.8	11.3
2700	0.857	122.3	1.50	118.4024	0.0048	168.3	0.768	136.4	6.9
2760	0.876	115.8	1.30	109.0173	0.0047	173.3	0.774	129.3	7.1
2820	0.886	109.5	1.13	98.04062	0.0056	-171.8	0.775	121.4	6.3
2880	0.900	103.2	0.99	88.75305	0.0058	-173.3	0.775	113.9	6.2
2940	0.908	97.4	0.84	80.06287	0.0069	175.4	0.775	106.6	5.6
3000	0.914	91.3	0.71	69.79065	0.0086	167.6	0.761	98.8	5.2

Figure 6-5. Gain versus Blocker at 1710 MHz (Compression)

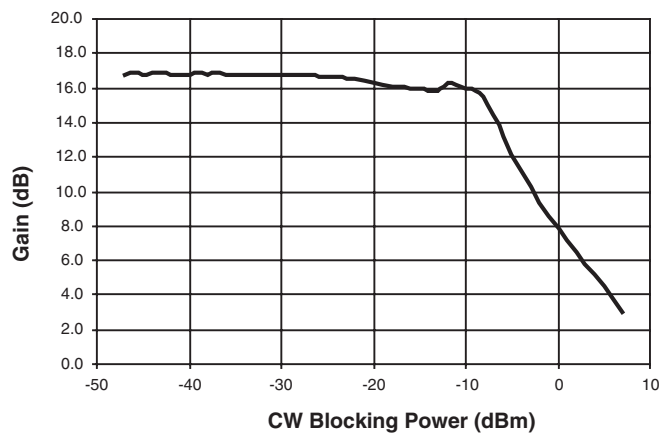

Figure 6-6. Out of Band Intermodulation Product 3rd Order (IP3)

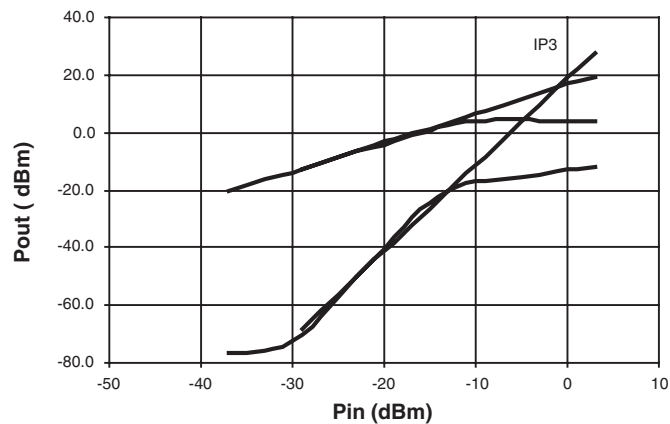

Figure 6-7. Inband Intermodulation Product 3rd Order (Inband IP3)

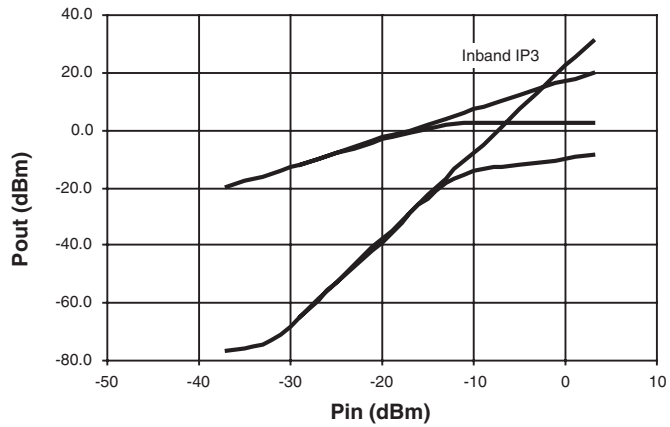

Figure 6-8. Noise Figure without any De-embedding

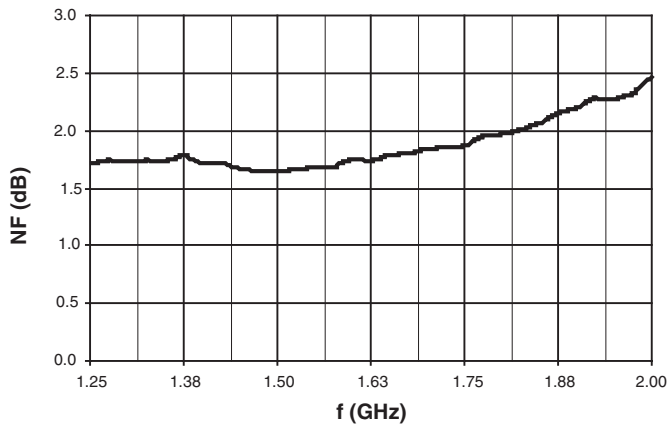
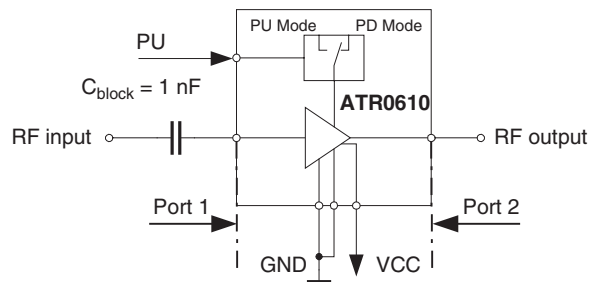

Figure 6-9. Reference Planes of Unmatched Device



6.2 Unmatched Device (see Figure 6-9 on page 8)

Table 6-2. Measured Scattering Parameters of Unmatched Device (De-embedded)
(Given as Linear Magnitude and Phase in Degree)

f/MHz	S11	φ(S11)	S21	φ(S21)	S12	φ(S12)	S22	φ(S22)
1.400	0.725	-116.0	6.04	132.8	0.028	63.1	0.400	104.5
1.425	0.712	-117.7	6.12	127.7	0.030	58.2	0.366	94.5
1.450	0.698	-119.3	6.17	122.6	0.031	53.0	0.332	83.6
1.475	0.682	-120.6	6.19	117.6	0.032	47.7	0.303	72.2
1.500	0.666	-122.0	6.18	112.7	0.033	42.0	0.278	60.2
1.525	0.647	-123.1	6.16	108.1	0.033	35.9	0.258	47.4
1.550	0.630	-123.9	6.10	103.8	0.034	29.5	0.244	35.0
1.575	0.610	-124.4	6.05	99.6	0.034	22.5	0.240	22.5
1.600	0.592	-124.6	5.98	95.8	0.034	15.9	0.240	10.8
1.625	0.573	-124.2	5.93	92.4	0.034	7.8	0.249	1.5
1.650	0.558	-123.3	5.92	89.4	0.032	-1.0	0.276	-7.1
1.675	0.552	-121.7	5.99	86.0	0.029	-9.0	0.315	-16.6
1.700	0.556	-120.5	6.05	82.0	0.026	-15.3	0.360	-27.3
1.725	0.565	-120.0	6.10	77.5	0.022	-18.7	0.404	-38.2
1.750	0.573	-120.1	6.10	72.9	0.020	-20.0	0.443	-48.6

Figure 6-10. Minimum Noise Figure NF_{min} (De-embedded)

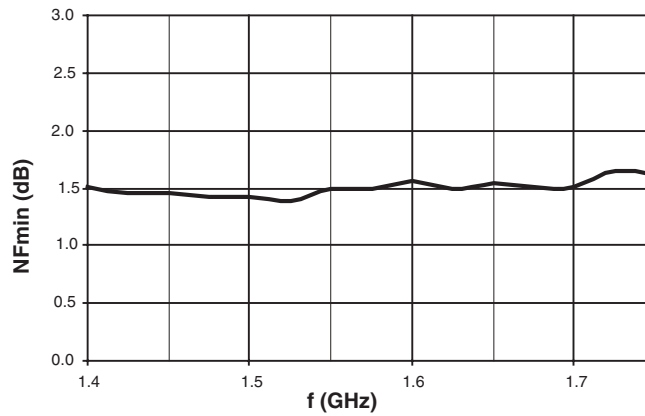
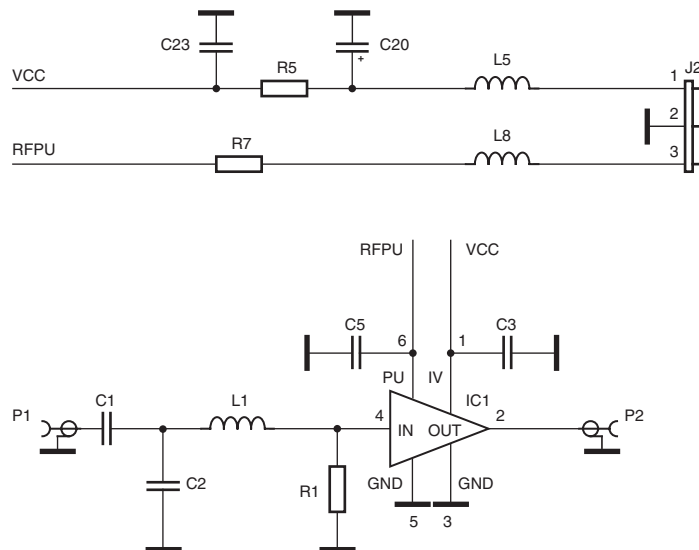

Table 6-3. Raw Noise Data of Unmatched Device (De-embedded)

f/GHz	NFmin/dB	$ \Gamma_{opt} $	$\phi(\Gamma_{opt})$	Rn/ Ω
1.400	1.51	0.31	98.07	8.89
1.425	1.46	0.31	98.55	8.71
1.450	1.45	0.31	100.00	9.30
1.475	1.43	0.31	100.16	9.13
1.500	1.43	0.31	101.78	8.70
1.525	1.38	0.32	103.08	9.15
1.550	1.49	0.31	104.16	9.41
1.575	1.49	0.31	106.49	8.78
1.600	1.57	0.28	109.84	9.05
1.625	1.50	0.30	110.74	8.22
1.650	1.54	0.31	112.12	8.41
1.675	1.52	0.31	113.20	8.61
1.700	1.52	0.31	113.33	8.40
1.725	1.65	0.28	116.76	8.61
1.700	1.52	0.31	113.33	8.40
1.725	1.65	0.28	116.76	8.61
1.750	1.62	0.31	115.03	8.24

Figure 6-11. Schematic of Application Board



7. Bill of Materials of Application Board

Component	Qty.	Value	Tolerance	Voltage	Material	Manufacturer	Manufacturer Order Code	Distributor	Distributor Order Code
R5	1	1	5%			Vishay®	CRCW04021R0J		
R7	1	1	5%			Vishay	CRCW04021R0J		
C2 ⁽¹⁾	1	1p2 ⁽²⁾	0.25 pF	25V	C0G	Murata®	GRM1555C1H1R2BZ01D		
L1 ⁽¹⁾	1	4n7 ⁽²⁾	5%			Würth® Elektronik	744784047		
C1 ⁽¹⁾	1	8p2 ⁽²⁾	±0.1 pF	25V	C0G	Vishay	VJ0402A8R2CXX		
C20	1	10μ	10%			Vishay	293D106X56R3A2.		
C23	1	100n	20%	16V	Y5V	Vishay	VJ0402V104MXJ		
P1, P2	2	142-0711-821				Johnson Components™	742-0711-821	RS Components	363-4729
IC1	1	ATR0610				Atmel®	ATR0610		
J2	1	JP2E				Molex®	90120-0762	RS Components	360-6241
L5, L8	2	WE74476401	10%			Würth Elektronik	74476401		
C3, C5	2	NC							
R1	1	NC							

- Notes:
1. L1, C1 and C2 are the only devices which are needed for final application. All other components are only used for the application board shown in [Figure 7-1](#).
 2. Depending on the layout of the final application board other values are possible.

Figure 7-1. Layout of Application Board

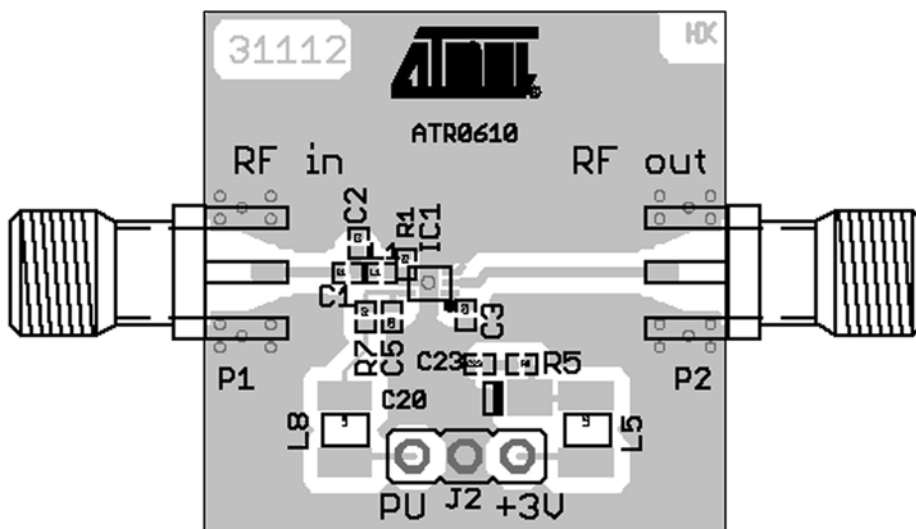

8. Ordering Information

Extended Type Number	Package	Remarks
ATR0610-PQQ	PLL6	Area 1.6 mm × 2.0 mm, 0.5 mm pitch, PB-free, RoHS compliant, green

9. Package Information

Package: PLL6, 1.6x2.0mm
Dimensions in mm

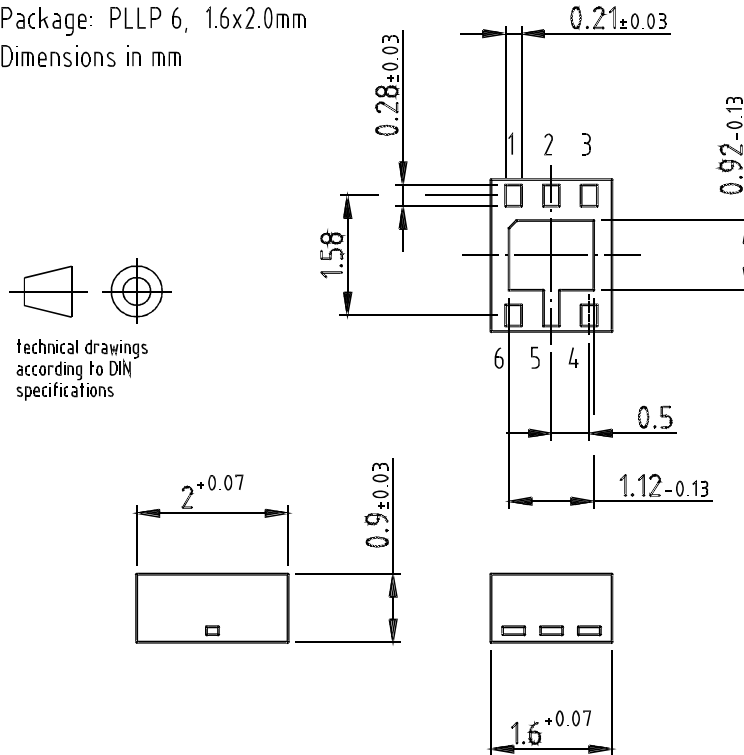

Drawing-No.: 6.549-5033.01-4
Issue: 1; 25.07.02

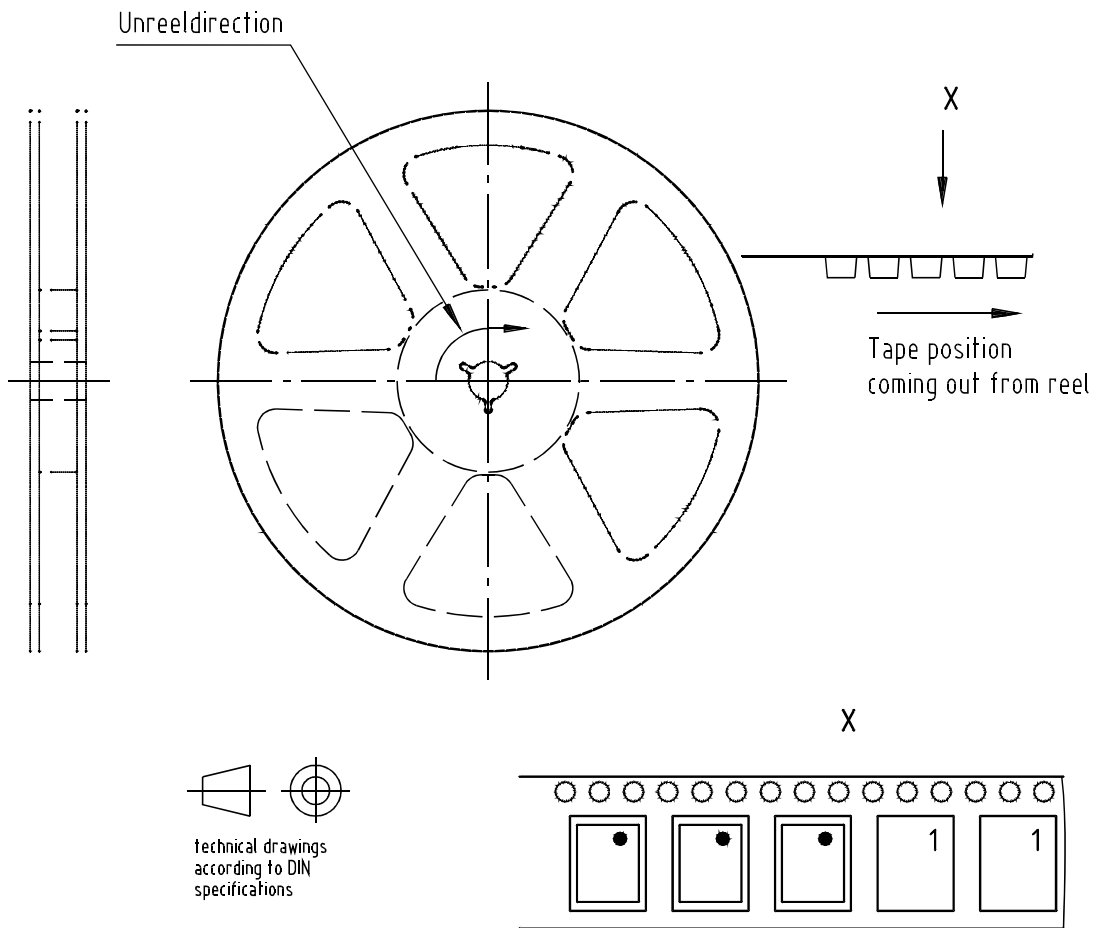

technical drawings according to DIN specifications

Drawing-No.: 9.800-5081.01-4.01-4
 Issue: 1; 24.10.02



10. Revision History

Please note that the following page numbers referred to in this section refer to the specific revision mentioned, not to this document.

Revision No.	History
4573H-GPS-11/06	<ul style="list-style-type: none">• Features on page 1 changed• Section 8 "Ordering Information" on page 12 changed
4573G-GPS-10/06	<ul style="list-style-type: none">• Put datasheet in a new template• ESD logo moved from page 1 to page 3• Section 7 "Bill of Materials of Application Board" on page 11 changed



Atmel Corporation

2325 Orchard Parkway
San Jose, CA 95131, USA
Tel: 1(408) 441-0311
Fax: 1(408) 487-2600

Regional Headquarters

Europe

Atmel Sarl
Route des Arsenaux 41
Case Postale 80
CH-1705 Fribourg
Switzerland
Tel: (41) 26-426-5555
Fax: (41) 26-426-5500

Asia

Room 1219
Chinachem Golden Plaza
77 Mody Road Tsimshatsui
East Kowloon
Hong Kong
Tel: (852) 2721-9778
Fax: (852) 2722-1369

Japan

9F, Tonetsu Shinkawa Bldg.
1-24-8 Shinkawa
Chuo-ku, Tokyo 104-0033
Japan
Tel: (81) 3-3523-3551
Fax: (81) 3-3523-7581

Atmel Operations

Memory

2325 Orchard Parkway
San Jose, CA 95131, USA
Tel: 1(408) 441-0311
Fax: 1(408) 436-4314

Microcontrollers

2325 Orchard Parkway
San Jose, CA 95131, USA
Tel: 1(408) 441-0311
Fax: 1(408) 436-4314

La Chantrerie
BP 70602
44306 Nantes Cedex 3, France
Tel: (33) 2-40-18-18-18
Fax: (33) 2-40-18-19-60

ASIC/ASSP/Smart Cards

Zone Industrielle
13106 Rousset Cedex, France
Tel: (33) 4-42-53-60-00
Fax: (33) 4-42-53-60-01

1150 East Cheyenne Mtn. Blvd.
Colorado Springs, CO 80906, USA
Tel: 1(719) 576-3300
Fax: 1(719) 540-1759

Scottish Enterprise Technology Park
Maxwell Building
East Kilbride G75 0QR, Scotland
Tel: (44) 1355-803-000
Fax: (44) 1355-242-743

RF/Automotive

Theresienstrasse 2
Postfach 3535
74025 Heilbronn, Germany
Tel: (49) 71-31-67-0
Fax: (49) 71-31-67-2340

1150 East Cheyenne Mtn. Blvd.
Colorado Springs, CO 80906, USA
Tel: 1(719) 576-3300
Fax: 1(719) 540-1759

Biometrics/Imaging/Hi-Rel MPU/ High-Speed Converters/RF Datacom

Avenue de Rochepleine
BP 123
38521 Saint-Egreve Cedex, France
Tel: (33) 4-76-58-30-00
Fax: (33) 4-76-58-34-80

Literature Requests

www.atmel.com/literature

Disclaimer: The information in this document is provided in connection with Atmel products. No license, express or implied, by estoppel or otherwise, to any intellectual property right is granted by this document or in connection with the sale of Atmel products. **EXCEPT AS SET FORTH IN ATMEL'S TERMS AND CONDITIONS OF SALE LOCATED ON ATMEL'S WEB SITE, ATMEL ASSUMES NO LIABILITY WHATSOEVER AND DISCLAIMS ANY EXPRESS, IMPLIED OR STATUTORY WARRANTY RELATING TO ITS PRODUCTS INCLUDING, BUT NOT LIMITED TO, THE IMPLIED WARRANTY OF MERCHANTABILITY, FITNESS FOR A PARTICULAR PURPOSE, OR NON-INFRINGEMENT. IN NO EVENT SHALL ATMEL BE LIABLE FOR ANY DIRECT, INDIRECT, CONSEQUENTIAL, PUNITIVE, SPECIAL OR INCIDENTAL DAMAGES (INCLUDING, WITHOUT LIMITATION, DAMAGES FOR LOSS OF PROFITS, BUSINESS INTERRUPTION, OR LOSS OF INFORMATION) ARISING OUT OF THE USE OR INABILITY TO USE THIS DOCUMENT, EVEN IF ATMEL HAS BEEN ADVISED OF THE POSSIBILITY OF SUCH DAMAGES.** Atmel makes no representations or warranties with respect to the accuracy or completeness of the contents of this document and reserves the right to make changes to specifications and product descriptions at any time without notice. Atmel does not make any commitment to update the information contained herein. Unless specifically provided otherwise, Atmel products are not suitable for, and shall not be used in, automotive applications. Atmel's products are not intended, authorized, or warranted for use as components in applications intended to support or sustain life.

© 2006 Atmel Corporation. All rights reserved. Atmel®, logo and combinations thereof, Everywhere You Are® and others are registered trademarks or trademarks of Atmel Corporation or its subsidiaries. Other terms and product names may be trademarks of others.