



LED...A70..4-..Q Series Sealed High-Intensity Area Lights

High-Power Lighting for use with PresencePLUS® and Other Vision Systems

Features



- Rugged, waterproof housing, rated IEC IP68
- Compact area light for PresencePLUS and other Vision systems
- Five extremely bright LEDs for illumination of targets from 0.15 meters to beyond 2 meters
- Smooth exterior for easy cleaning during washdown
- Optically isolated strobe signal
- Available with 316 stainless steel or nickel-plated aluminum housing and a choice of either acrylic or tempered optical glass windows
- Fixed and adjustable intensity (see models below)
- Selectable Active High or Active Low strobe option

Models

Nickel-Plated Aluminum Housing				
Model*			LED Color	Optional Ambient Light Filter Kit for PresencePLUS Cameras
Acrylic Window	Glass Window	Diffuse Window (acrylic)		
LEDIA70AP4-XQ	LEDIA70AG4-XQ	LEDILA70AD4-XQ	Infrared, 850 nm	FLTI
LEDRA70AP4-XQ	LEDRA70AG4-XQ	LEDRA70AD4-XQ	Red, 625 nm	FLTR
LEDBA70AP4-XQ	LEDBA70AG4-XQ	LEDBA70AD4-XQ	Blue, 470 nm	FLTB
LEDGA70AP4-XQ	LEDGA70AG4-XQ	LEDGA70AD4-XQ	Green, 530 nm	FLTG
LEDWA70AP4-XQ	LEDWA70AG4-XQ	LEDWA70AD4-XQ	White, 5500 K	FLTB or FLTG



316 Stainless Steel Housing				
Model*			LED Color	Optional Ambient Light Filter Kit for PresencePLUS Cameras
Acrylic Window	Glass Window	Diffuse Window (acrylic)		
LEDIA70SSP4-XQ	LEDIA70SSG4-XQ	LEDIA70SSD4-XQ	Infrared, 850 nm	FLTI
LEDRA70SSP4-XQ	LEDRA70SSG4-XQ	LEDRA70SSD4-XQ	Red, 625 nm	FLTR
LEDBA70SSP4-XQ	LEDBA70SSG4-XQ	LEDBA70SSD4-XQ	Blue, 470 nm	FLTB
LEDGA70SSP4-XQ	LEDGA70SSG4-XQ	LEDGA70SSD4-XQ	Green, 530 nm	FLTG
LEDWA70SSP4-XQ	LEDWA70SSG4-XQ	LEDWA70SSD4-XQ	White, 5500 K	FLTB or FLTG

* For models with controllable intensity, replace "XQ" with "PQ" in the model number (for example, LEDRA70AP4-PQ).

Light Adjustment for Controllable Intensity Models

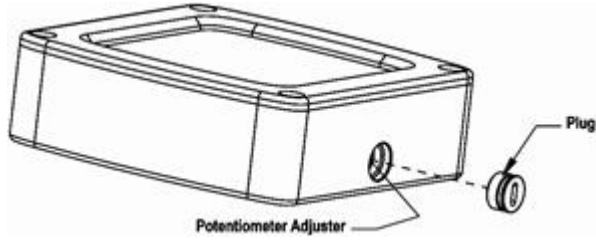

Remove plug as shown in Figure 1, using a small flat-blade screwdriver. Adjust the light's intensity by turning the 270° Intensity potentiometer with the screwdriver. Apply power to the light and turn the potentiometer all the way clockwise for max. intensity. If the object to be sensed is too bright at max. intensity, turn the potentiometer down a little at a time, testing with the object, until the correct brightness is achieved. When adjustment is complete, reinsert plug.

Figure 1. Potentiometer adjuster

Specifications

Feature	Description
Light Source	Five high-intensity LEDs; see models table for wavelength
Illumination	610 mm (24") diameter usable light pattern at 1 m
Strobe	Optically isolated
Supply Voltage and Current	<p>Operating Voltage: 24V dc \pm10%</p> <p>Strobe Voltage: 5-24V dc @ 15 mA maximum</p> <p>Current Draw at Full Intensity: 350 mA max</p> <p>Built-in constant current regulator for LEDs</p> <p>Potentiometer controls variable intensity for "P" models</p>
Connections	5 pin Euro-style (M12) male connector; accessory cable required for operation, see Cables for options

Feature	Description
Construction	Housing: nickel-plated aluminum or 316 stainless steel, depending on model Window: acrylic or glass, depending on model
Environmental Rating	Nickel-plated models: IEC IP68 Stainless steel models: NEMA 4X; IP68
Useful Life	50,000 hours (LED ON time). When operated within specifications, output will decrease less than 30% after 50,000 hours.
Operating Conditions	Temperature: 0° to +50° C (+32° to 122° F)

Dimensions

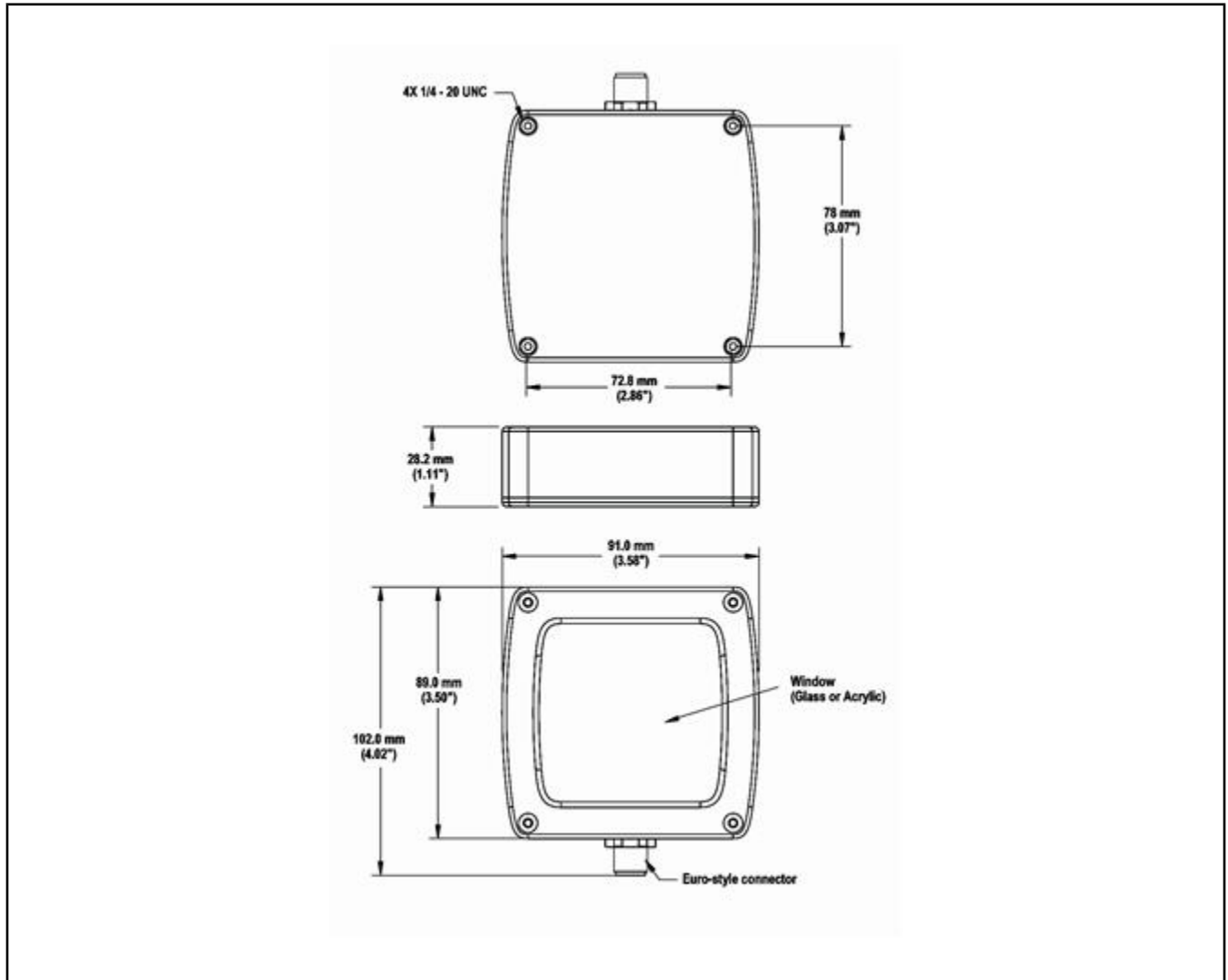

Wiring Table

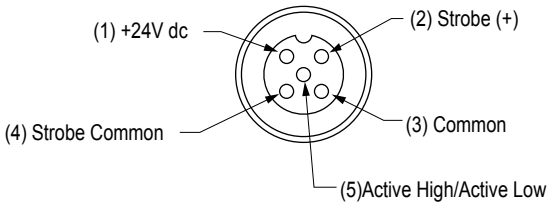
Wire Purpose	Cable Wire Color*	Continuous On Mode	Strobed Mode	PresencePlus Pro Controller Terminal Block
Power Wires	Brown (1)	+24V dc	+24V dc	Pin 01
	Blue (3)	common	common	Pin 02
Strobe Polarity Control	Gray (5)	open	Active Low: open Active High: connect to common (Blue wire)	Pin 02
Strobe Voltage Wires	White (2)	open	0V dc = ON (Active Low) 0V dc = OFF (Active High) +5 to 24V dc = OFF (Active Low) +5 to 24V dc = ON (Active High)	Pin 04
	Black (4)	open	Strobe common	Pin 02
 <p style="text-align: center;">Figure 1: Pinouts for Mating Cable</p>				

* For Banner-supplied wire.



 **Note:** To meet CE certification requirements, the light needs to be connected to earth ground.

Cables

Model	Length	Description	Use With
MQDC20-506 MQDC20-515 MQDC20-530	2 m (6') 5 m (15') 9 m (30')	5-wire cable, straight female Euro-style (M12) connector at one end; flying leads at opposite end	Nickel-plated models
MQDC20SS-506 MQDC20SS-515 MQDC20SS-530	2 m (6') 5 m (15') 9 m (30')	5-wire cable, straight female Euro-style (M12) 316 stainless steel connector at one end; flying leads at opposite end	Stainless steel models

 **Note:** These 5-wire cables can also be used on 4-pin connector lights.

Accessory Brackets

SMBASCM	<ul style="list-style-type: none"> • 316 stainless steel column-mounting bracket with 430 stainless steel threaded insert • Four ¼-20 stainless steel screws included 	
SMBAMS70AS	<ul style="list-style-type: none"> • 316 stainless steel right-angle bracket • Articulated slots for 90+ degrees rotation • Four ¼-20 stainless steel screws included 	

Replacement Window Kits

Model	Description
LEDA70SW-P	Clear acrylic
LEDA70SW-G	Clear glass
LEDA70SCDW-P	Clear diffuse acrylic
LEDA70SWDW-P	White diffuse acrylic



Warranty: Banner Engineering Corp. will repair or replace, free of charge, any product of its manufacture found to be defective at the time it is returned to the factory during the warranty period. This warranty does not cover damage or liability for the improper application of Banner products. This warranty is in lieu of any other warranty either expressed or implied.