

DDR2 Registered SDRAM MODULE

240pin Registered Module based on 2Gb A-die
72-bit ECC

**60FBGA and 83FBGA with Lead-Free and Halogen-Free
(RoHS compliant)**

INFORMATION IN THIS DOCUMENT IS PROVIDED IN RELATION TO SAMSUNG PRODUCTS, AND IS SUBJECT TO CHANGE WITHOUT NOTICE. NOTHING IN THIS DOCUMENT SHALL BE CONSTRUED AS GRANTING ANY LICENSE, EXPRESS OR IMPLIED, BY ESTOPPEL OR OTHERWISE, TO ANY INTELLECTUAL PROPERTY RIGHTS IN SAMSUNG PRODUCTS OR TECHNOLOGY. ALL INFORMATION IN THIS DOCUMENT IS PROVIDED ON AS "AS IS" BASIS WITHOUT GUARANTEE OR WARRANTY OF ANY KIND.

1. For updates or additional information about Samsung products, contact your nearest Samsung office.
2. Samsung products are not intended for use in life support, critical care, medical, safety equipment, or similar applications where Product failure could result in loss of life or personal or physical harm, or any military or defense application, or any governmental procurement to which special terms or provisions may apply.

* Samsung Electronics reserves the right to change products or specification without notice.

Table of Contents

1.0 DDR2 Registered DIMM Ordering Information	4
2.0 Features	4
3.0 Address Configuration	4
4.0 Pin Configurations (Front side/Back side)	5
5.0 Pin Description	5
6.0 Input/Output Function Description	6
7.0 Functional Block Diagram :	7
7.1 8GB, 1Gx72 Module - M393T1K66AZA.....	7
7.2 4GB, 512Mx72 Module - M393T5263AZA.....	8
8.0 Absolute Maximum DC Ratings	9
9.0 AC & DC Operating Conditions	9
9.1 Recommended DC Operating Conditions (SSTL - 1.8)	9
9.2 Operating Temperature Condition	10
9.3 Input DC Logic Level	10
9.4 Input AC Logic Level	10
9.5 AC Input Test Conditions	10
10.0 IDD Specification Parameters Definition	11
11.0 Operating Current Table :	12
11.1 M393T1K66AZA	12
11.2 M393T1K66AZA - considering Register and PLL current value	12
11.3 M393T5263AZA	13
11.4 M393T5263AZA - considering Register and PLL current value	13
12.0 Input/Output Capacitance	14
13.0 Electrical Characteristics & AC Timing for DDR2-800/667	14
13.1 Refresh Parameters by Device Density	14
13.2 Speed Bins and CL, tRCD, tRP, tRC and tRAS for Corresponding Bin	14
13.3 Timing Parameters by Speed Grade	15
14.0 Physical Dimensions :	17
14.1 st.1Gbx4 based 1Gx72 Module (2 Ranks)	17
14.2 256Mx8 based 512Mx72 Module (2 Ranks)	18
15.0 240 Pin DDR2 Registered DIMM Clock Topology	19

Revision History

Revision	Month	Year	History
1.0	December	2007	- Initial Release
1.1	July	2008	- Applied JEDEC update(JESD79-2E) on AC timing table
1.2	August	2008	- Added up 2Rx8 product.

1.0 DDR2 Registered DIMM Ordering Information

Part Number	Density	Organization	Component Composition	Number of Rank	Parity Register	Height
M393T1K66AZA-CF7/E6	8GB	1Gx72	st.1Gx4(K4T4G264QA)*18EA	2	O	30mm
M393T5263AZA-CF7/E6	8GB	512Mx72	256Mx8(K4T2G084QA)*18EA	2	O	30mm

Note :

1. "Z" of Part number(11th digit) stands for Lead-Free and RoHS compliant products.
2. "A" of Part number(12th digit) stands for Parity Register products.

2.0 Features

- Performance range

	F7(DDR2-800)	E6(DDR2-667)	Unit
Speed@CL3	-	400	Mbps
Speed@CL4	533	533	Mbps
Speed@CL5	667	667	Mbps
Speed@CL6	800	-	Mbps
CL-tRCD-tRP	6-6-6	5-5-5	CK

- JEDEC standard $V_{DD} = 1.8V \pm 0.1V$ Power Supply
- $V_{DDQ} = 1.8V \pm 0.1V$
- 333MHz f_{CK} for 667Mb/sec/pin, 400MHz f_{CK} for 800Mb/sec/pin
- 8 Banks
- Posted \overline{CAS}
- Programmable \overline{CAS} Latency: 3, 4, 5, 6
- Programmable Additive Latency: 0, 1, 2, 3, 4 and 5
- Write Latency(WL) = Read Latency(RL) -1
- Burst Length: 4, 8(Interleave/Nibble sequential)
- Programmable Sequential / Interleave Burst Mode
- Bi-directional Differential Data-Strobe (Single-ended data-strobe is an optional feature)
- Off-Chip Driver(OCD) Impedance Adjustment
- On Die Termination with selectable values(50/75/150 ohms or disable)
- Average Refresh Period 7.8us at lower than a $T_{CASE} 85^{\circ}C$, 3.9us at $85^{\circ}C < T_{CASE} \leq 95^{\circ}C$
- Support High Temperature Self-Refresh rate enable feature
- Serial presence detect with EEPROM
- DDR2 SDRAM Package: 60ball FBGA - 256Mx8, 83ball FBGA - St. 1G x4(512Mx4 2Gb base)
- All of base components are Lead-Free, Halogen-Free, and RoHS compliant

Note : For detailed DDR2 SDRAM operation, please refer to Samsung's Device operation & Timing diagram.

3.0 Address Configuration

Organization	Row Address	Column Address	Bank Address	Auto Precharge
512Mx4(2Gb) based Module	A0-A14	A0-A9, A11	BA0-BA2	A10
256Mx8(2Gb) based Module	A0-A14	A0-A9	BA0-BA2	A10

4.0 Pin Configurations (Front side/Back side)

Pin	Front	Pin	Back	Pin	Front	Pin	Back	Pin	Front	Pin	Back	Pin	Front	Pin	Back
1	V _{REF}	121	V _{SS}	31	DQ19	151	V _{SS}	61	A4	181	V _{DDQ}	91	V _{SS}	211	DM5/DQS14
2	V _{SS}	122	DQ4	32	V _{SS}	152	DQ28	62	V _{DDQ}	182	A3	92	DQS5	212	NC/DQS14
3	DQ0	123	DQ5	33	DQ24	153	DQ29	63	A2	183	A1	93	DQS5	213	V _{SS}
4	DQ1	124	V _{SS}	34	DQ25	154	V _{SS}	64	V _{DD}	184	V _{DD}	94	V _{SS}	214	DQ46
5	V _{SS}	125	DM0/DQS9	35	V _{SS}	155	DM3/DQS12	KEY				95	DQ42	215	DQ47
6	DQS0	126	NC/DQS9	36	DQS3	156	NC/DQS12	65	V _{SS}	185	CK0	96	DQ43	216	V _{SS}
7	DQS0	127	V _{SS}	37	DQS3	157	V _{SS}	66	V _{SS}	186	CK0	97	V _{SS}	217	DQ52
8	V _{SS}	128	DQ6	38	V _{SS}	158	DQ30	67	V _{DD}	187	V _{DD}	98	DQ48	218	DQ53
9	DQ2	129	DQ7	39	DQ26	159	DQ31	68	NC/Par_In	188	A0	99	DQ49	219	V _{SS}
10	DQ3	130	V _{SS}	40	DQ27	160	V _{SS}	69	V _{DD}	189	V _{DD}	100	V _{SS}	220	RFU
11	V _{SS}	131	DQ12	41	V _{SS}	161	CB4	70	A10/AP	190	BA1	101	SA2	221	RFU
12	DQ8	132	DQ13	42	CB0	162	CB5	71	BA0	191	V _{DDQ}	102	NC(TEST)	222	V _{SS}
13	DQ9	133	V _{SS}	43	CB1	163	V _{SS}	72	V _{DDQ}	192	RAS	103	V _{SS}	223	DM6/DQS15
14	V _{SS}	134	DM1/DQS10	44	V _{SS}	164	DM8/DQS17	73	WE	193	S0	104	DQS6	224	NC/DQS15
15	DQS1	135	NC/DQS10	45	DQS8	165	NC/DQS17	74	CAS	194	V _{DDQ}	105	DQS6	225	V _{SS}
16	DQS1	136	V _{SS}	46	DQS8	166	V _{SS}	75	V _{DDQ}	195	ODT0	106	V _{SS}	226	DQ54
17	V _{SS}	137	RFU	47	V _{SS}	167	CB6	76	S1 ⁴	196	A13	107	DQ50	227	DQ55
18	RESET	138	RFU	48	CB2	168	CB7	77	ODT1	197	V _{DD}	108	DQ51	228	V _{SS}
19	NC	139	V _{SS}	49	CB3	169	V _{SS}	78	V _{DDQ}	198	V _{SS}	109	V _{SS}	229	DQ60
20	V _{SS}	140	DQ14	50	V _{SS}	170	V _{DDQ}	79	V _{SS}	199	DQ36	110	DQ56	230	DQ61
21	DQ10	141	DQ15	51	V _{DDQ}	171	CKE1 ⁴	80	DQ32	200	DQ37	111	DQ57	231	V _{SS}
22	DQ11	142	V _{SS}	52	CKE0	172	V _{DD}	81	DQ33	201	V _{SS}	112	V _{SS}	232	DM7/DQS16
23	V _{SS}	143	DQ20	53	V _{DD}	173	NC	82	V _{SS}	202	DM4/DQS13	113	DQS7	233	NC/DQS16
24	DQ16	144	DQ21	54	BA2	174	A14	83	DQS4	203	NC/DQS13	114	DQS7	234	V _{SS}
25	DQ17	145	V _{SS}	55	NC/Err_Out	175	V _{DDQ}	84	DQS4	204	V _{SS}	115	V _{SS}	235	DQ62
26	V _{SS}	146	DM2/DQS11	56	V _{DDQ}	176	A12	85	V _{SS}	205	DQ38	116	DQ58	236	DQ63
27	DQS2	147	NC/DQS11	57	A11	177	A9	86	DQ34	206	DQ39	117	DQ59	237	V _{SS}
28	DQS2	148	V _{SS}	58	A7	178	V _{DD}	87	DQ35	207	V _{SS}	118	V _{SS}	238	V _{DDSPD}
29	V _{SS}	149	DQ22	59	V _{DD}	179	A8	88	V _{SS}	208	DQ44	119	SDA	239	SA0
30	DQ18	150	DQ23	60	A5	180	A6	89	DQ40	209	DQ45	120	SCL	240	SA1
								90	DQ41	210	V _{SS}				

NC = No Connect, RFU = Reserved for Future Use

1. RESET (Pin 18) is connected to both OE of PLL and Reset of register.
2. The Test pin (Pin 102) is reserved for bus analysis probes and is not connected on normal memory modules (DIMMs)
3. NC/Err_Out (Pin 55) and NC/Par_In (Pin 68) are for optional function to check address and command parity.
4. CKE1,S1 Pin is used for double side Registered DIMM.

5.0 Pin Description

Pin Name	Description	Pin Name	Description
CK0	Clock Inputs, positive line	ODT0~ODT1	On die termination
CK0	Clock inputs, negative line	DQ0~DQ63	Data Input/Output
CKE0, CKE1	Clock Enables	CB0~CB7	Data check bits Input/Output
RAS	Row Address Strobe	DQS0~DQS8	Data strobes
CAS	Column Address Strobe	DQS0~DQS8	Data strobes, negative line
WE	Write Enable	DM(0~8), DQS(9~17)	Data Masks / Data strobes (Read)
S0, S1	Chip Selects	DQS9~DQS17	Data strobes (Read), negative line
A0~A9, A11~A14	Address Inputs	RFU	Reserved for Future Use
A10/AP	Address Input/Autoprecharge	NC	No Connect
BA0~BA2	DDR2 SDRAM Bank Address	TEST	Memory bus test tool (Not Connect and Not Useable on DIMMs)
SCL	Serial Presence Detect (SPD) Clock Input	V _{DD}	Core Power
SDA	SPD Data Input/Output	V _{DDQ}	I/O Power
SA0~SA2	SPD address	V _{SS}	Ground
Par_In	Parity bit for the Address and Control bus	V _{REF}	Input/Output Reference
Err_Out	Parity error found in the Address and Control bus	V _{DDSPD}	SPD Power
RESET	Register and PLL control pin		

* The V_{DD} and V_{DDQ} pins are tied to the single power-plane on PCB.

6.0 Input/Output Function Description

Symbol	Type	Description
CK0	Input	Positive line of the differential pair of system clock inputs that drives input to the on-DIMM PLL.
$\overline{\text{CK0}}$	Input	Negative line of the differential pair of system clock inputs that drives the input to the on-DIMM PLL.
CKE0~CKE1	Input	Activates the SDRAM CK signal when high and deactivates the CK signal when low. By deactivating the clocks, CKE low initiates the Power Down mode, or the Self Refresh mode.
$\overline{\text{S0}}\sim\overline{\text{S1}}$	Input	Enables the associated SDRAM command decoder when low and disables decoder when high. When decoder is disabled, new commands are ignored but previous operations continue. These input signals also disable all outputs (except CKE and ODT) of the register(s) on the DIMM when both inputs are high.
ODT0~ODT1	Input	I/O bus impedance control signals.
$\overline{\text{RAS}}, \overline{\text{CAS}}, \overline{\text{WE}}$	Input	When sampled at the positive rising edge of the clock, $\overline{\text{CAS}}$, $\overline{\text{RAS}}$, and $\overline{\text{WE}}$ define the operation to be executed by the SDRAM.
V_{REF}	Supply	Reference voltage for SSTL_18 inputs
V_{DDQ}	Supply	Isolated power supply for the DDR SDRAM output buffers to provide improved noise immunity
BA0~BA2	Input	Selects which SDRAM bank of eight is activated.
A0~A9,A10/AP A11~A14	Input	During a Bank Activate command cycle, Address defines the row address. During a Read or Write command cycle, Address defines the column address. In addition to the column address, AP is used to invoke autoprecharge operation at the end of the burst read or write cycle. If AP is high, autoprecharge is selected and BA0, BA1, BA2 defines the bank to be precharged. If AP is low, autoprecharge is disabled. During a Precharge command cycle, AP is used in conjunction with BA0, BA1, BA2 to control which bank(s) to precharge. If AP is high, all banks will be precharged regardless of the state of BA0 or BA1 or BA2. If AP is low, BA0 and BA1 and BA2 are used to define which bank to precharge.
DQ0~63, CB0~CB7	In/Out	Data and Check Bit Input/Output pins
DM0~DM8	Input	Masks write data when high, issued concurrently with input data. Both DM and DQ have a write latency of one clock once the write command is registered into the SDRAM.
$V_{\text{DD}}, V_{\text{SS}}$	Supply	Power and ground for the DDR SDRAM input buffers and core logic
DQS0~DQS17	In/Out	Positive line of the differential data strobe for input and output data.
$\overline{\text{DQS0}}\sim\overline{\text{DQS17}}$	In/Out	Negative line of the differential data strobe for input and output data.
SA0~SA2	Input	These signals are tied at the system planar to either V_{SS} or V_{DDSPD} to configure the serial SPD EEPROM address range.
SDA	In/Out	This bidirectional pin is used to transfer data into or out of the SPD EEPROM. A resistor must be connected from the SDA bus line to V_{DDSPD} to act as a pullup.
SCL	Input	This signal is used to clock data into and out of the SPD EEPROM. A resistor may be connected from the SCL bus time to V_{DDSPD} to act as a pullup.
V_{DDSPD}	Supply	Serial EEPROM positive power supply (wired to a separate power pin at the connector which supports from 1.7 Volt to 3.6 Volt operation).
$\overline{\text{RESET}}$	Input	The $\overline{\text{RESET}}$ pin is connected to the $\overline{\text{RST}}$ pin on the register and to the OE pin on the PLL. When low, all register outputs will be driven low and the PLL clocks to the DRAMs and register(s) will be set to low level (The PLL will remain synchronized with the input clock)
Par_In	Input	Parity bit for the Address and Control bus. ("1" : Odd, "0" : Even)
$\overline{\text{Err_Out}}$	Input	Parity error found in the Address and Control bus
TEST	In/Out	Used by memory bus analysis tools (unused on memory DIMMs)

7.0 Functional Block Diagram :

7.1 8GB, 1Gx72 Module - M393T1K66AZA

(populated as 2 rank of x4 DDR2 SDRAMs)

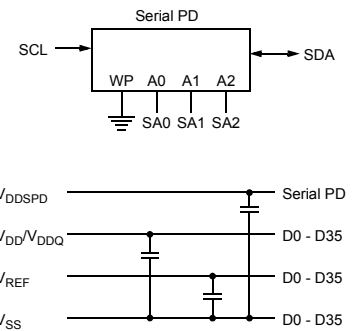
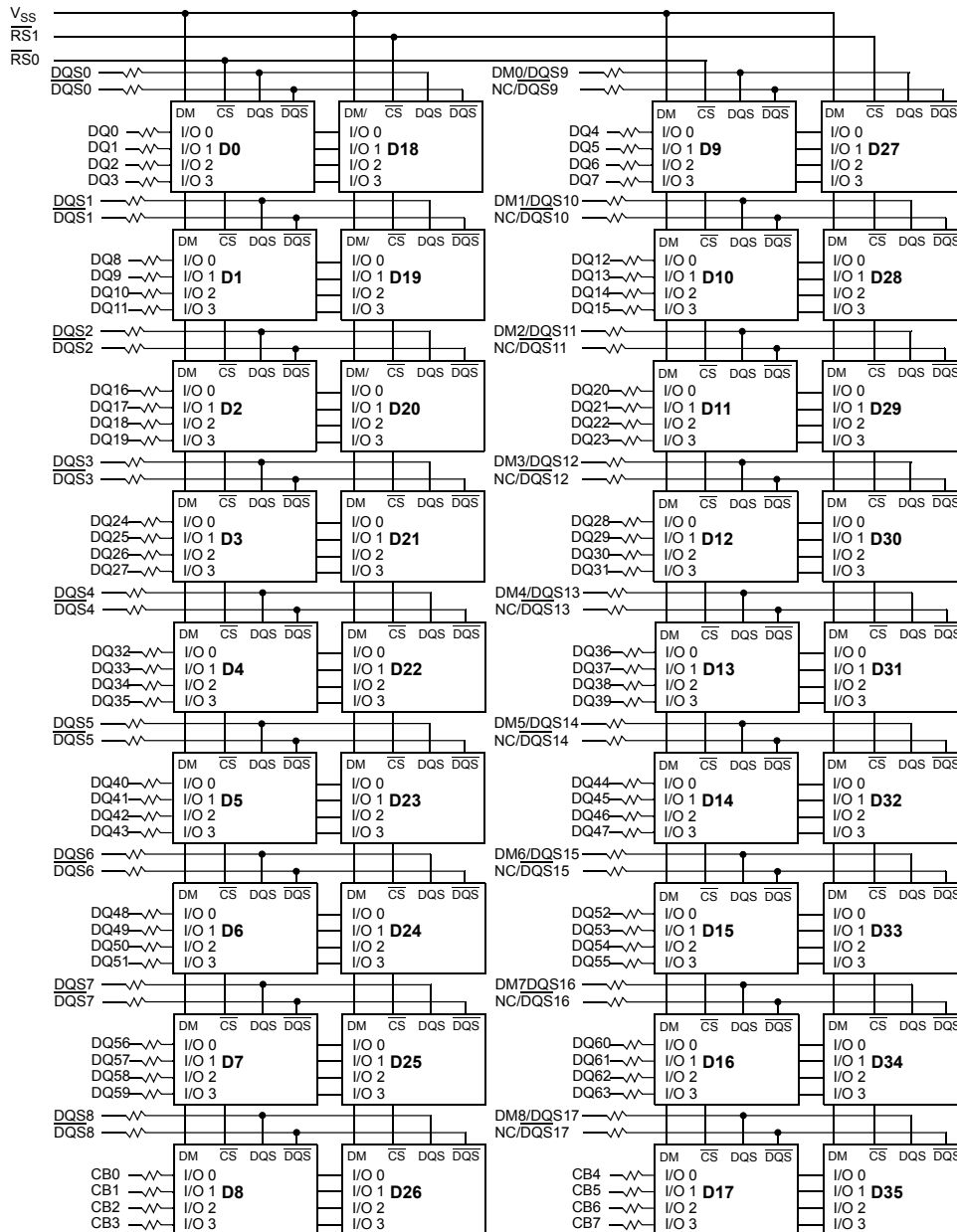

Signals for Address and Command Parity Function (M393T1K66AZA)

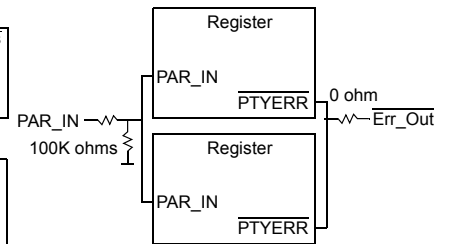

0 Ohm resistor on Err_Out is not populated for non-parity card.

The resistors on Par_In, A13, A14, A15, BA2 and the signal line of Err_Out refer to the section: "Register Options for Unused Address inputs"

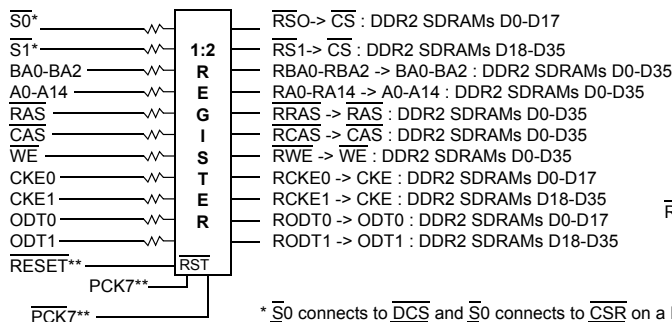

* S0 connects to DCS and S0 connects to CSR on a Register, S1 connects to DCS and S0 connects to CSR on another Register.
 ** RESET, PCK7 and PCK7 connects to both Registers. Other signals connect to one of two Registers.

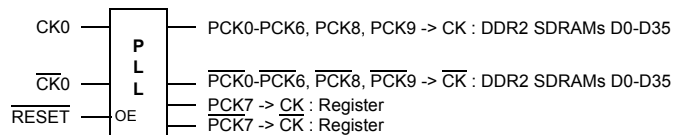

7.2 4GB, 512Mx72 Module - M393T5263AZA

(populated as 2 rank of x8 DDR2 SDRAMs)

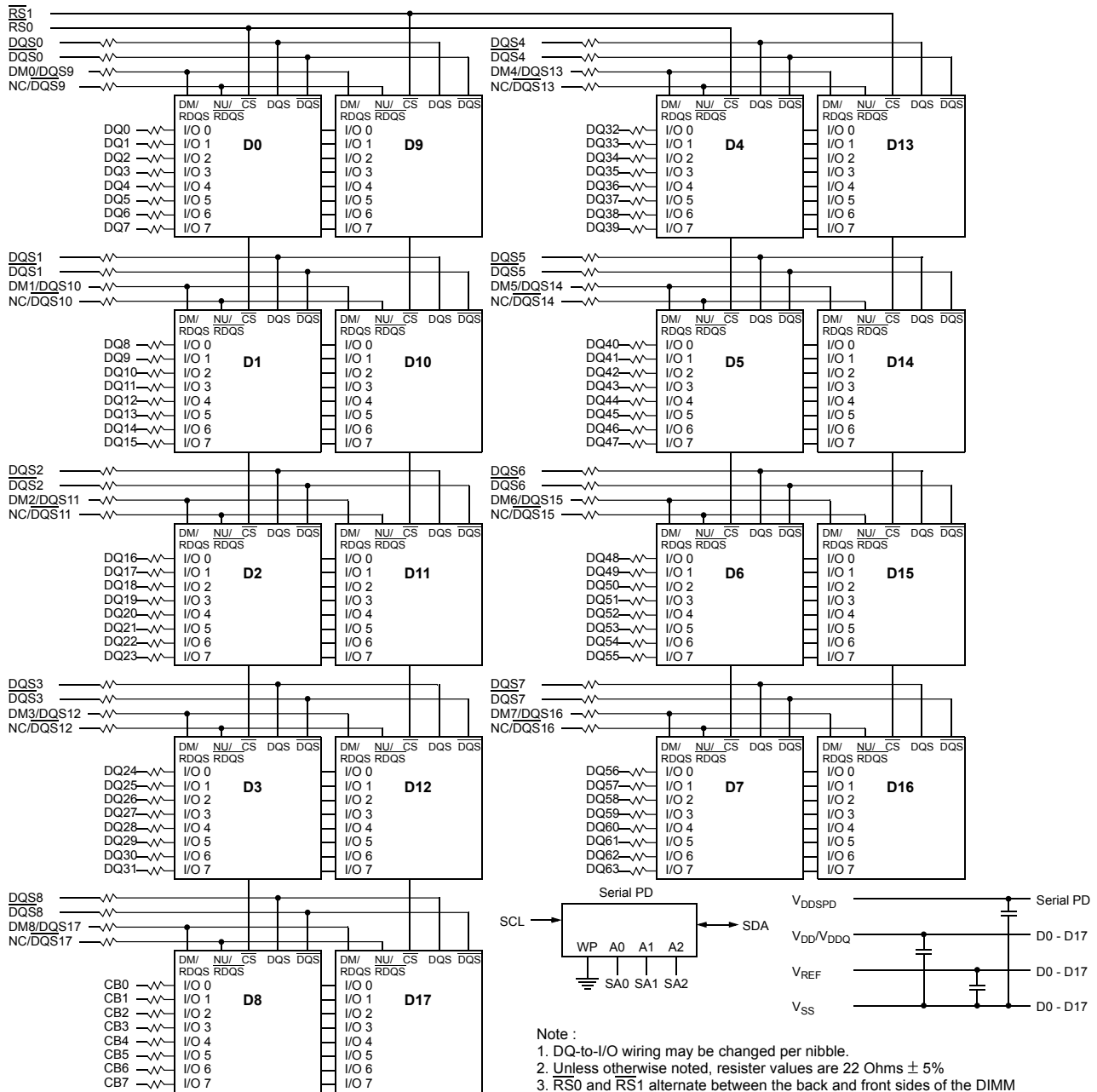

- Note :
1. DQ-to-I/O wiring may be changed per nibble.
 2. Unless otherwise noted, resistor values are 22 Ohms ± 5%
 3. RS0 and RS1 alternate between the back and front sides of the DIMM

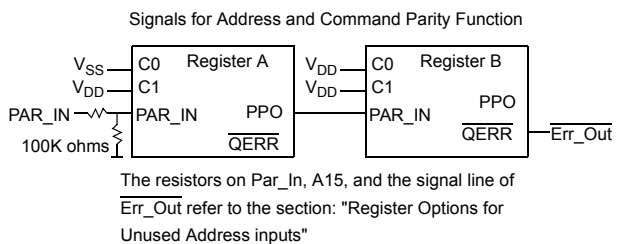
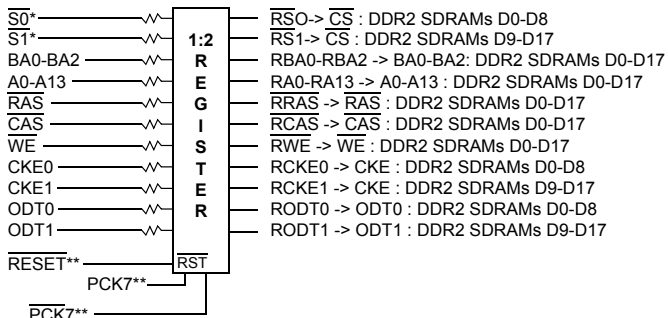

The resistors on Par_In, A15, and the signal line of Err_Out refer to the section: "Register Options for Unused Address inputs"

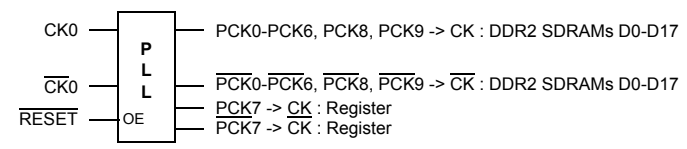

* S0 connects to DCS and S1 connects to CSR on a Register, S1 connects to DCS and S0 connects to CSR on another Register.
 ** RESET, PCK7 and PCK7 connects to both Registers. Other signals connect to one of two Registers.



8.0 Absolute Maximum DC Ratings

Symbol	Parameter	Rating	Units	Notes
V_{DD}	Voltage on V_{DD} pin relative to V_{SS}	- 1.0 V ~ 2.3 V	V	1
V_{DDQ}	Voltage on V_{DDQ} pin relative to V_{SS}	- 0.5 V ~ 2.3 V	V	1
V_{DDL}	Voltage on V_{DDL} pin relative to V_{SS}	- 0.5 V ~ 2.3 V	V	1
V_{IN}, V_{OUT}	Voltage on any pin relative to V_{SS}	- 0.5 V ~ 2.3 V	V	1
T_{STG}	Storage Temperature	-55 to +100	°C	1, 2

Note :

- Stresses greater than those listed under "Absolute Maximum Ratings" may cause permanent damage to the device. This is a stress rating only and functional operation of the device at these or any other conditions above those indicated in the operational sections of this specification is not implied. Exposure to absolute maximum rating conditions for extended periods may affect reliability.
- Storage Temperature is the case surface temperature on the center/top side of the DRAM. For the measurement conditions, please refer to JESD51-2 standard.

9.0 AC & DC Operating Conditions

9.1 Recommended DC Operating Conditions (SSTL - 1.8)

Symbol	Parameter	Rating			Units	Notes
		Min.	Typ.	Max.		
V_{DD}	Supply Voltage	1.7	1.8	1.9	V	
V_{DDL}	Supply Voltage for DLL	1.7	1.8	1.9	V	4
V_{DDQ}	Supply Voltage for Output	1.7	1.8	1.9	V	4
V_{REF}	Input Reference Voltage	$0.49 \times V_{DDQ}$	$0.50 \times V_{DDQ}$	$0.51 \times V_{DDQ}$	mV	1,2
V_{TT}	Termination Voltage	$V_{REF} - 0.04$	V_{REF}	$V_{REF} + 0.04$	V	3

Note : There is no specific device V_{DD} supply voltage requirement for SSTL-1.8 compliance. However under all conditions V_{DDQ} must be less than or equal to V_{DD} .

- The value of V_{REF} may be selected by the user to provide optimum noise margin in the system. Typically the value of V_{REF} is expected to be about $0.5 \times V_{DDQ}$ of the transmitting device and V_{REF} is expected to track variations in V_{DDQ} .
- Peak to peak AC noise on V_{REF} may not exceed $\pm 2\% V_{REF}(DC)$.
- V_{TT} of transmitting device must track V_{REF} of receiving device.
- AC parameters are measured with V_{DD} , V_{DDQ} and V_{DDL} tied together.

9.2 Operating Temperature Condition

Symbol	Parameter	Rating	Units	Notes
T _{OPER}	Operating Temperature	0 to 95	°C	1, 2

Note :

- Operating Temperature is the case surface temperature on the center/top side of the DRAM. For the measurement conditions, please refer to JESD51.2 standard.
- At 85 - 95 °C operation temperature range, doubling refresh commands in frequency to a 32ms period (t_{REFI}=3.9 us) is required, and to enter to self refresh mode at this temperature range, an EMRS command is required to change internal refresh rate.

9.3 Input DC Logic Level

Symbol	Parameter	Min.	Max.	Units	Notes
V _{IH} (DC)	DC input logic high	V _{REF} + 0.125	V _{DDQ} + 0.3	V	
V _{IL} (DC)	DC input logic low	- 0.3	V _{REF} - 0.125	V	

9.4 Input AC Logic Level

Symbol	Parameter	DDR2-667, DDR2-800		Units
		Min.	Max.	
V _{IH} (AC)	AC input logic high	V _{REF} + 0.200	-	V
V _{IL} (AC)	AC input logic low	-	V _{REF} - 0.200	V

9.5 AC Input Test Conditions

Symbol	Condition	Value	Units	Notes
V _{REF}	Input reference voltage	0.5 * V _{DDQ}	V	1
V _{SWING(MAX)}	Input signal maximum peak to peak swing	1.0	V	1
SLEW	Input signal minimum slew rate	1.0	V/ns	2, 3

Notes:

- Input waveform timing is referenced to the input signal crossing through the V_{IH/IL}(AC) level applied to the device under test.
- The input signal minimum slew rate is to be maintained over the range from V_{REF} to V_{IH}(AC) min for rising edges and the range from V_{REF} to V_{IL}(AC) max for falling edges as shown in the below figure.
- AC timings are referenced with input waveforms switching from V_{IL}(AC) to V_{IH}(AC) on the positive transitions and V_{IH}(AC) to V_{IL}(AC) on the negative transitions.

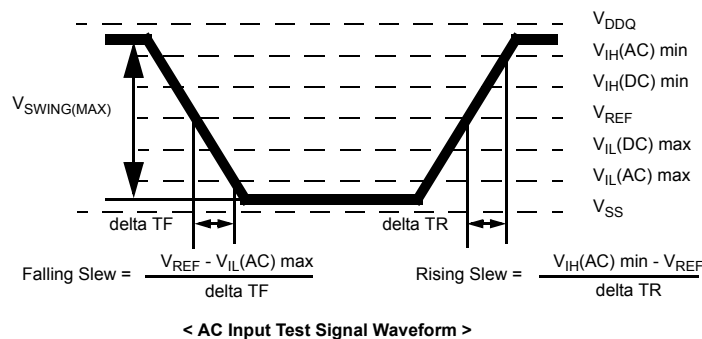

10.0 IDD Specification Parameters Definition

(IDD values are for full operating range of Voltage and Temperature)

Symbol	Proposed Conditions	Units	Note
IDD0	Operating one bank active-precharge current; tCK = tCK(IDD), tRC = tRC(IDD), tRAS = tRASmin(IDD); CKE is HIGH, \overline{CS} is HIGH between valid commands; Address bus inputs are SWITCHING; Data bus inputs are SWITCHING	mA	
IDD1	Operating one bank active-read-precharge current; IOU _T = 0mA; BL = 4, CL = CL(IDD), AL = 0; tCK = tCK(IDD), tRC = tRC(IDD), tRAS = tRASmin(IDD), tRCD = tRCD(IDD); CKE is HIGH, \overline{CS} is HIGH between valid commands; Address bus inputs are SWITCHING; Data pattern is same as IDD4W	mA	
IDD2P	Precharge power-down current; All banks idle; tCK = tCK(IDD); CKE is LOW; Other control and address bus inputs are STABLE; Data bus inputs are FLOATING	mA	
IDD2Q	Precharge quiet standby current; All banks idle; tCK = tCK(IDD); CKE is HIGH, \overline{CS} is HIGH; Other control and address bus inputs are STABLE; Data bus inputs are FLOATING	mA	
IDD2N	Precharge standby current; All banks idle; tCK = tCK(IDD); CKE is HIGH, \overline{CS} is HIGH; Other control and address bus inputs are SWITCHING; Data bus inputs are SWITCHING	mA	
IDD3P	Active power-down current; All banks open; tCK = tCK(IDD); CKE is LOW; Other control and address bus inputs are STABLE; Data bus inputs are FLOATING	Fast PDN Exit MRS(12) = 0mA	mA
		Slow PDN Exit MRS(12) = 1mA	mA
IDD3N	Active standby current; All banks open; tCK = tCK(IDD), tRAS = tRASmax(IDD), tRP = tRP(IDD); CKE is HIGH, \overline{CS} is HIGH between valid commands; Other control and address bus inputs are SWITCHING; Data bus inputs are SWITCHING	mA	
IDD4W	Operating burst write current; All banks open, Continuous burst writes; BL = 4, CL = CL(IDD), AL = 0; tCK = tCK(IDD), tRAS = tRASmax(IDD), tRP = tRP(IDD); CKE is HIGH, \overline{CS} is HIGH between valid commands; Address bus inputs are SWITCHING; Data bus inputs are SWITCHING	mA	
IDD4R	Operating burst read current; All banks open, Continuous burst reads, IOU _T = 0mA; BL = 4, CL = CL(IDD), AL = 0; tCK = tCK(IDD), tRAS = tRASmax(IDD), tRP = tRP(IDD); CKE is HIGH, \overline{CS} is HIGH between valid commands; Address bus inputs are SWITCHING; Data pattern is same as IDD4W	mA	
IDD5B	Burst auto refresh current; tCK = tCK(IDD); Refresh command at every tRFC(IDD) interval; CKE is HIGH, \overline{CS} is HIGH between valid commands; Other control and address bus inputs are SWITCHING; Data bus inputs are SWITCHING	mA	
IDD6	Self refresh current; CK and \overline{CK} at 0V; CKE ≤ 0.2V; Other control and address bus inputs are FLOATING; Data bus inputs are FLOATING	Normal	mA
		Low Power	mA
IDD7	Operating bank interleave read current; All bank interleaving reads, IOU _T = 0mA; BL = 4, CL = CL(IDD), AL = tRCD(IDD)-1*tCK(IDD); tCK = tCK(IDD), tRC = tRC(IDD), tRRD = tRRD(IDD), tFAW = tFAW(IDD), tRCD = 1*tCK(IDD); CKE is HIGH, \overline{CS} is HIGH between valid commands; Address bus inputs are STABLE during DESELECTs; Data pattern is same as IDD4R; Refer to the following page for detailed timing conditions	mA	

11.0 Operating Current Table :

11.1 M393T1K66AZA

(TA=0°C, V_{DD}= 1.9V)

Symbol	F7 (DDR2-800@CL=6)	E6 (DDR2-667@CL=5)	Unit	Notes
IDD0	3,150	2,610	mA	
IDD1	3,600	2,970	mA	
IDD2P	540	540	mA	
IDD2Q	1,980	1,800	mA	
IDD2N	2,160	1,980	mA	
IDD3P-F	1,800	1,440	mA	
IDD3P-S	648	648	mA	
IDD3N	2,880	2,250	mA	
IDD4W	4,500	3,690	mA	
IDD4R	5,040	4,050	mA	
IDD5B	6,480	5,670	mA	
IDD6*	Normal	540	mA	
IDD7	7,740	6,750	mA	

* Module IDD was calculated on the basis of component IDD and can be differently measured according to DQ loading cap.

11.2 M393T1K66AZA - considering Register and PLL current value

(TA=0°C, V_{DD}= 1.9V)

Symbol	F7 (DDR2-800@CL=6)	E6 (DDR2-667@CL=5)	Unit	Notes
IDD0	3,810	3,480	mA	
IDD1	4,400	3,970	mA	
IDD2P	1,490	1,400	mA	
IDD2Q	3,040	2,720	mA	
IDD2N	2,960	2,680	mA	
IDD3P-F	2,890	2,380	mA	
IDD3P-S	1,738	1,588	mA	
IDD3N	3,310	2,940	mA	
IDD4W	5,130	4,540	mA	
IDD4R	5,770	4,990	mA	
IDD5B	7,340	6,670	mA	
IDD6*	Normal	540	mA	
IDD7	9,090	8,200	mA	

* IDD6 = DRAM current + standby current of PLL and Register

** Module IDD was calculated on the basis of component IDD and can be differently measured according to DQ loading cap.

11.3 M393T5263AZA

(TA=0°C, V_{DD}= 1.9V)

Symbol		F7 (DDR2-800@CL=6)	E6 (DDR2-667@CL=5)	Unit	Notes
IDD0		1,575	1,305	mA	
IDD1		1,800	1,485	mA	
IDD2P		270	270	mA	
IDD2Q		990	900	mA	
IDD2N		1,080	990	mA	
IDD3P-F		900	720	mA	
IDD3P-S		324	324	mA	
IDD3N		1,440	1,125	mA	
IDD4W		2,250	1,845	mA	
IDD4R		2,520	2,025	mA	
IDD5B		3,240	2,835	mA	
IDD6*	Normal	270	270	mA	
IDD7		3,870	3,375	mA	

* Module IDD was calculated on the basis of component IDD and can be differently measured according to DQ loading cap.

11.4 M393T5263AZA - considering Register and PLL current value

(TA=0°C, V_{DD}= 1.9V)

Symbol		F7 (DDR2-800@CL=6)	E6 (DDR2-667@CL=5)	Unit	Notes
IDD0		2,265	1,895	mA	
IDD1		2,570	2,145	mA	
IDD2P		910	850	mA	
IDD2Q		1,700	1,520	mA	
IDD2N		1,650	1,490	mA	
IDD3P-F		1,630	1,350	mA	
IDD3P-S		1,054	954	mA	
IDD3N		2,000	1,615	mA	
IDD4W		2,900	2,405	mA	
IDD4R		3,310	2,705	mA	
IDD5B		4,070	3,515	mA	
IDD6*	Normal	270	270	mA	
IDD7		4,900	4,245	mA	

* IDD6 = DRAM current + standby current of PLL and Register

** Module IDD was calculated on the basis of component IDD and can be differently measured according to DQ loading cap.

12.0 Input/Output Capacitance

(V_{DD}=1.8V, V_{DDQ}=1.8V, T_A=25°C)

Parameter	Symbol	Min	Max	Min	Max	Units
Part-Number		M393T1K66AZA		M393T5263AZA		
Input capacitance, CK and \overline{CK}	CCK	-	11	-	11	pF
Input capacitance, CKE and \overline{CS}	CI1	-	12	-	12	
Input capacitance, Address, \overline{RAS} , \overline{CAS} , \overline{WE}	CI2	-	12	-	12	
Input/output capacitance, DQ, DM, DQS, \overline{DQS}	CIO	-	10	-	10	

* DM is internally loaded to match DQ and DQS identically.

13.0 Electrical Characteristics & AC Timing for DDR2-800/667

(0 °C ≤ T_{OPER} ≤ 95 °C; V_{DDQ} = 1.8V ± 0.1V; V_{DD} = 1.8V ± 0.1V)

13.1 Refresh Parameters by Device Density

Parameter	Symbol	256Mb	512Mb	1Gb	2Gb	4Gb	Units	
Refresh to active/Refresh command time	tRFC	75	105	127.5	195	327.5	ns	
Average periodic refresh interval	tREFI	0 °C ≤ T _{CASE} ≤ 85°C	7.8	7.8	7.8	7.8	7.8	μs
		85 °C < T _{CASE} ≤ 95°C	3.9	3.9	3.9	3.9	3.9	μs

13.2 Speed Bins and CL, tRCD, tRP, tRC and tRAS for Corresponding Bin

Speed	DDR2-800(F7)		DDR2-667(E6)		Units
Bin(CL - tRCD - tRP)	6 - 6 - 6		5 - 5 - 5		
Parameter	min	max	min	max	
tCK, CL=3	-	-	5	8	ns
tCK, CL=4	3.75	8	3.75	8	ns
tCK, CL=5	3	8	3	8	ns
tCK, CL=6	2.5	8	-	-	ns
tRCD	15	-	15	-	ns
tRP	15	-	15	-	ns
tRC	60	-	60	-	ns
tRAS	45	70000	45	70000	ns

13.3 Timing Parameters by Speed Grade

(Refer to notes for informations related to this table at the component datasheet)

Parameter	Symbol	DDR2-800		DDR2-667		Units	Notes
		min	max	min	max		
DQ output access time from CK/CK	tAC	-400	400	-450	450	ps	40
DQS output access time from CK/CK	tDQSCK	-350	350	-400	400	ps	40
Average clock HIGH pulse width	tCH(avg)	0.48	0.52	0.48	0.52	tCK(avg)	35,36
Average clock LOW pulse width	tCL(avg)	0.48	0.52	0.48	0.52	tCK(avg)	35,36
CK half pulse period	tHP	Min(tCL(abs), tCH(abs))	x	Min(tCL(abs), tCH(abs))	x	ps	37
Average clock period	tCK(avg)	2500	8000	3000	8000	ps	35,36
DQ and DM input hold time	tDH(base)	125	x	175	x	ps	6,7,8,21,28,31
DQ and DM input setup time	tDS(base)	50	x	100	x	ps	6,7,8,20,28,31
Control & Address input pulse width for each input	tIPW	0.6	x	0.6	x	tCK(avg)	
DQ and DM input pulse width for each input	tDIPW	0.35	x	0.35	x	tCK(avg)	
Data-out high-impedance time from CK/CK	tHZ	x	tAC(max)	x	tAC(max)	ps	18,40
DQS/DQS low-impedance time from CK/CK	tLZ(DQS)	tAC(min)	tAC(max)	tAC(min)	tAC(max)	ps	18,40
DQ low-impedance time from CK/CK	tLZ(DQ)	2* tAC(min)	tAC(max)	2* tAC(min)	tAC(max)	ps	18,40
DQS-DQ skew for DQS and associated DQ signals	tDQSQ	x	200	x	240	ps	13
DQ hold skew factor	tQHS	x	300	x	340	ps	38
DQ/DQS output hold time from DQS	tQH	tHP - tQHS	x	tHP - tQHS	x	ps	39
DQS latching rising transitions to associated clock edges	tDQSS	- 0.25	0.25	-0.25	0.25	tCK(avg)	30
DQS input HIGH pulse width	tDQSH	0.35	x	0.35	x	tCK(avg)	
DQS input LOW pulse width	tDQSL	0.35	x	0.35	x	tCK(avg)	
DQS falling edge to CK setup time	tDSS	0.2	x	0.2	x	tCK(avg)	30
DQS falling edge hold time from CK	tDSH	0.2	x	0.2	x	tCK(avg)	30
Mode register set command cycle time	tMRD	2	x	2	x	nCK	
MRS command to ODT update delay	tMOD	0	12	0	12	ns	32
Write postamble	tWPST	0.4	0.6	0.4	0.6	tCK(avg)	10
Write preamble	tWPRE	0.35	x	0.35	x	tCK(avg)	
Address and control input hold time	tIH(base)	250	x	275	x	ps	5,7,9,23,29
Address and control input setup time	tIS(base)	175	x	200	x	ps	5,7,9,22,29
Read preamble	tRPRE	0.9	1.1	0.9	1.1	tCK(avg)	19,41
Read postamble	tRPST	0.4	0.6	0.4	0.6	tCK(avg)	19,42
Activate to activate command period for 1KB page size products	tRRD	7.5	x	7.5	x	ns	4,32
Activate to activate command period for 2KB page size products	tRRD	10	x	10	x	ns	4,32

Parameter	Symbol	DDR2-800		DDR2-667		Units	Notes
		min	max	min	max		
Four Activate Window for 1KB page size products	tFAW	35	x	37.5	x	ns	32
Four Activate Window for 2KB page size products	tFAW	45	x	50	x	ns	32
CAS to CAS command delay	tCCD	2	x	2	x	nCK	
Write recovery time	tWR	15	x	15	x	ns	32
Auto precharge write recovery + precharge time	tDAL	WR + tnRP	x	WR + tnRP	x	nCK	33
Internal write to read command delay	tWTR	7.5	x	7.5	x	ns	24,32
Internal read to precharge command delay	tRTP	7.5	x	7.5	x	ns	3,32
Exit self refresh to a non-read command	tXSNR	tRFC + 10	x	tRFC + 10	x	ns	32
Exit self refresh to a read command	tXSRD	200	x	200	x	nCK	
Exit precharge power down to any command	tXP	2	x	2	x	nCK	
Exit active power down to read command	tXARD	2	x	2	x	nCK	1
Exit active power down to read command (slow exit, lower power)	tXARDS	8 - AL	x	7 - AL	x	nCK	1,2
CKE minimum pulse width (HIGH and LOW pulse width)	tCKE	3	x	3	x	nCK	27
ODT turn-on delay	tAOND	2	2	2	2	nCK	16
ODT turn-on	tAON	tAC(min)	tAC(max)+0.7	tAC(min)	tAC(max)+0.7	ns	6,16,40
ODT turn-on (Power-Down mode)	tAONPD	tAC(min)+2	2*tCK(avg)+tAC(max)+1	tAC(min)+2	2*tCK(avg)+tAC(max)+1	ns	
ODT turn-off delay	tAOFD	2.5	2.5	2.5	2.5	nCK	17,45
ODT turn-off	tAOF	tAC(min)	tAC(max)+0.6	tAC(min)	tAC(max)+0.6	ns	17,43,45
ODT turn-off (Power-Down mode)	tAOFDP	tAC(min)+2	2.5*tCK(avg)+tAC(max)+1	tAC(min)+2	2.5*tCK(avg)+tAC(max)+1	ns	
ODT to power down entry latency	tANPD	3	x	3	x	nCK	
ODT power down exit latency	tAXPD	8	x	8	x	nCK	
OCD drive mode output delay	tOIT	0	12	0	12	ns	32
Minimum time clocks remains ON after CKE asynchronously drops LOW	tDelay	tIS+tCK(avg)+tIH	x	tIS+tCK(avg)+tIH	x	ns	15

14.0 Physical Dimensions :

14.1 st.1Gbx4 based 1Gx72 Module (2 Ranks)
- M393T1K66AZA

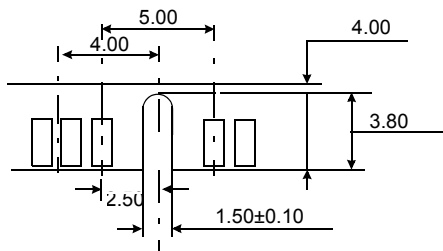
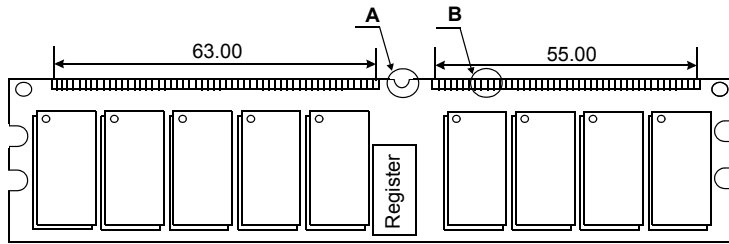
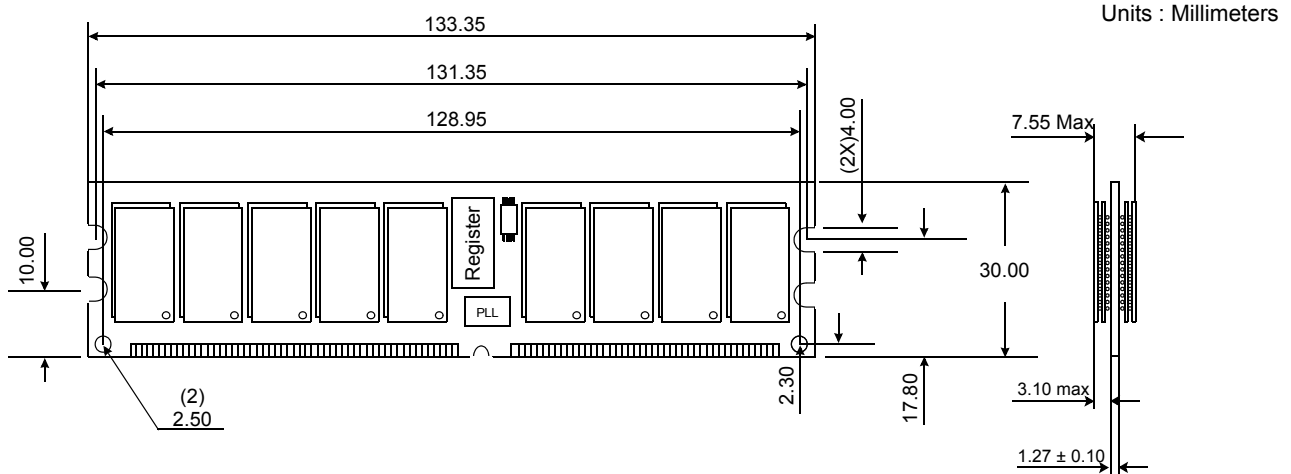

Detail A

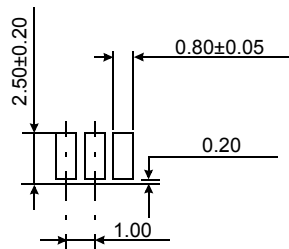

Detail B

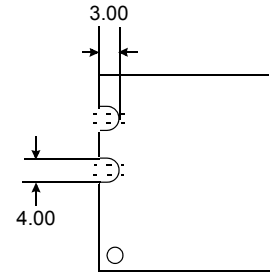

The used device is st.1G x4 DDR2 SDRAM.
DDR2 SDRAM Part NO : K4T4G264QA

14.2 256Mx8 based 512Mx72 Module (2 Ranks)
 - M393T5263AZA

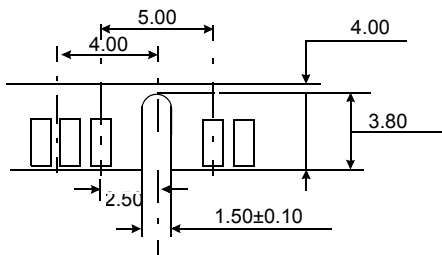
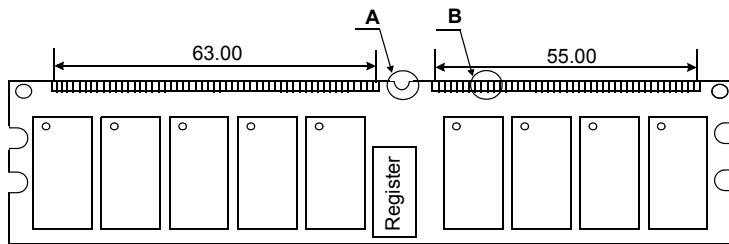
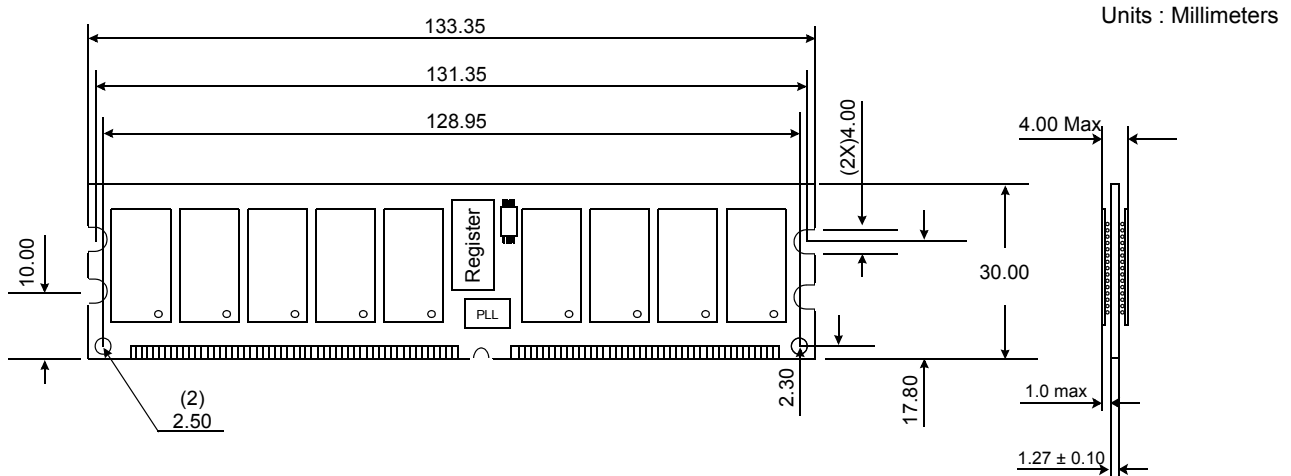

Detail A

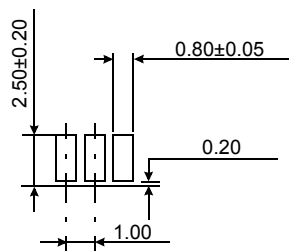

Detail B

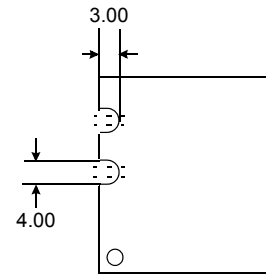

The used device is 256M x8 DDR2 SDRAM, FBGA.
 DDR2 SDRAM Part NO : K4T2G084QA

15.0 240 Pin DDR2 Registered DIMM Clock Topology

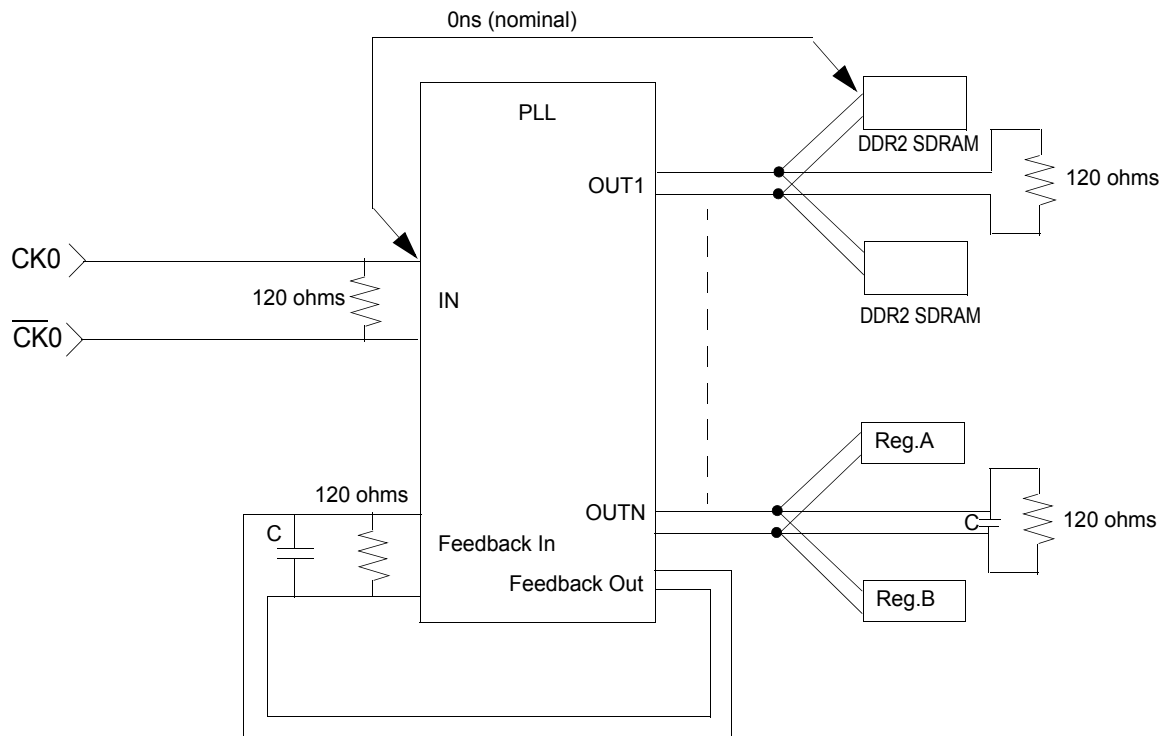

Note :

1. The clock delay from the input of the PLL clock to the input of any DDR2 SDRAM or register will be set to 0ns (nominal).
2. Input, output, and feedback clock lines are terminated from line to line as shown, and not from line to ground.
3. Only one PLL output is shown per output type. Any additional PLL outputs will be wired in a similar manner.
4. Termination resistors for the PLL feedback path clocks are located as close to the input pin of the PLL as possible.