

SYNCHRONOUS DRAM MODULE

MT5LSDT472A – 32MB
MT5LSDT872A(I) – 64MB
MT5LSDT1672A(I) – 128MB

For the latest data sheet, please refer to the Micron® Web site: www.micron.com/products/modules

Features

- 168-pin, dual in-line memory module (DIMM)
- PC100- and PC133-compliant
- Unbuffered
- 32MB (4 Meg x 72), 64MB (8 Meg x 72), 128MB (16 Meg x 72)
- Supports ECC error detection and correction
- Single +3.3V power supply
- Fully synchronous; all signals registered on positive edge of system clock
- Internal pipelined operation; column address can be changed every clock cycle
- Internal SDRAM banks for hiding row access/precharge
- Programmable burst lengths: 1, 2, 4, 8, or full page
- Auto Precharge, including CONCURRENT AUTO PRECHARGE, and Auto Refresh Modes
- Self Refresh Mode: 64ms, 4,096-cycle refresh for 32MB and 64MB; 64ms, 8,192-cycle refresh for 128MB
- LVTTL-compatible inputs and outputs
- Serial Presence-Detect (SPD)
- Gold edge contacts

Figure 1: 168-Pin DIMM (MO-161)

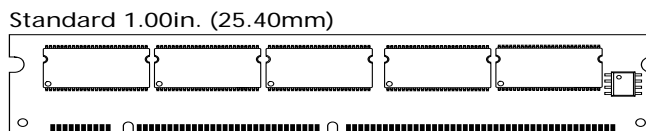

Options

- Package
 - 168-pin DIMM (standard) G
 - 168-pin DIMM (lead-free) Y¹
- Operating Temperature Range
 - Commercial (0°C to +65°C) None
 - Industrial (-40°C to +85°C) I²
- Frequency / CAS Latency
 - 7.5ns (133 MHz) / CL = 2 -13E
 - 7.5ns (133 MHz) / CL = 3 -133
 - 8ns (100 MHz) / CL = 2 -10E

Marking

Table 1: Timing Parameters

CL = CAS (READ) latency

MODULE MARKING	CLOCK FREQUENCY	ACCESS TIME		SETUP TIME	HOLD TIME
		CL = 2	CL = 3		
-13E	133 MHz	5.4ns	–	1.5	0.8
-133	133 MHz	–	5.4ns	1.5	0.8
-10E	100 MHz	9ns	7.5ns	2ns	1ns

- NOTE: 1. Consult Micron for product availability.
 2. Industrial Temperature option available in -133 speed only.

Table 2: Address Table

	32MB	64MB	128MB
Refresh Count	4K	4K	8K
Device Banks	4 (BA0, BA1)	4 (BA0, BA1)	4 (BA0, BA1)
Device Configuration	64Mb (4 Meg x 16)	128Mb (8 Meg x 16)	256Mb (16 Meg x 16)
Row Addressing	4K (A0-A11)	4K (A0-A11)	8K (A0-A12)
Column Addressing	256 (A0-A7)	512 (A0-A8)	512 (A0-A8)
Module Ranks	1 (S0#, S2#)	1 (S0#, S2#)	1 (S0#, S2#)

Table 3: Part Numbers

PART NUMBER	MODULE DENSITY	CONFIGURATION	SYSTEM BUS SPEED
MT5LSDT472AG-13E_	32MB	4 Meg x 72	133 MHz
MT5LSDT472AY-13E_	32MB	4 Meg x 72	133 MHz
MT5LSDT472AG-133_	32MB	4 Meg x 72	133 MHz
MT5LSDT472AY-133_	32MB	4 Meg x 72	133 MHz
MT5LSDT472AG-10E_	32MB	4 Meg x 72	100 MHz
MT5LSDT472AY-10E_	32MB	4 Meg x 72	100 MHz
MT5LSDT872AG-13E_	64MB	8 Meg x 72	133 MHz
MT5LSDT872AY-13E_	64MB	8 Meg x 72	133 MHz
MT5LSDT872A(I)G-133_	64MB	8Meg x 72	133 MHz
MT5LSDT872A(I)Y-133_	64MB	8Meg x 72	133 MHz
MT5LSDT872AG-10E_	64MB	8 Meg x 72	100 MHz
MT5LSDT872AY-10E_	64MB	8 Meg x 72	100 MHz
MT5LSDT1672AG-13E_	128MB	16 Meg x 72	133 MHz
MT5LSDT1672AY-13E_	128MB	16 Meg x 72	133 MHz
MT5LSDT1672A(I)G-133_	128MB	16 Meg x 72	133 MHz
MT5LSDT1672A(I)Y-133_	128MB	16 Meg x 72	133 MHz
MT5LSDT1672AG-10E_	128MB	16 Meg x 72	100 MHz
MT5LSDT1672AY-10E_	128MB	16 Meg x 72	100 MHz

NOTE:

The designators for component and PCB revision are the last two characters of each part number. Consult factory for current revision codes. Example: MT5LSDT1672AG-133B1.

**Table 4: Pin Assignment
(168-Pin DIMM Front)**

PIN	SYMBOL	PIN	SYMBOL	PIN	SYMBOL	PIN	SYMBOL
1	Vss	22	CB1	43	Vss	64	Vss
2	DQ0	23	Vss	44	NC	65	DQ21
3	DQ1	24	NC	45	S2#	66	DQ22
4	DQ2	25	NC	46	DQM2	67	DQ23
5	DQ3	26	VDD	47	DQM3	68	Vss
6	VDD	27	WE#	48	NC	69	DQ24
7	DQ4	28	DQM0	49	VDD	70	DQ25
8	DQ5	29	DQM1	50	NC	71	DQ26
9	DQ6	30	S0#	51	NC	72	DQ27
10	DQ7	31	NC	52	CB2	73	VDD
11	DQ8	32	Vss	53	CB3	74	DQ28
12	Vss	33	A0	54	Vss	75	DQ29
13	DQ9	34	A2	55	DQ16	76	DQ30
14	DQ10	35	A4	56	DQ17	77	DQ31
15	DQ11	36	A6	57	DQ18	78	Vss
16	DQ12	37	A8	58	DQ19	79	CK2
17	DQ13	38	A10	59	VDD	80	NC
18	VDD	39	BA1	60	DQ20	81	WP
19	DQ14	40	VDD	61	NC	82	SDA
20	DQ15	41	VDD	62	NC	83	SCL
21	CB0	42	CKO	63	NC	84	VDD

**Table 5: Pin Assignment
(168-Pin DIMM Back)**

PIN	SYMBOL	PIN	SYMBOL	PIN	SYMBOL	PIN	SYMBOL
85	Vss	106	CB5	127	Vss	148	Vss
86	DQ32	107	Vss	128	CKE0	149	DQ53
87	DQ33	108	NC	129	DNU	150	DQ54
88	DQ34	109	NC	130	DQM6	151	DQ55
89	DQ35	110	VDD	131	DQM7	152	Vss
90	VDD	111	CAS#	132	DNU	153	DQ56
91	DQ36	112	DQM4	133	VDD	154	DQ57
92	DQ37	113	DQM5	134	NC	155	DQ58
93	DQ38	114	DNU	135	NC	156	DQ59
94	DQ39	115	RAS#	136	CB6	157	VDD
95	DQ40	116	Vss	137	CB7	158	DQ60
96	Vss	117	A1	138	Vss	159	DQ61
97	DQ41	118	A3	139	DQ48	160	DQ62
98	DQ42	119	A5	140	DQ49	161	DQ63
99	DQ43	120	A7	141	DQ50	162	Vss
100	DQ44	121	A9	142	DQ51	163	DNU
101	DQ45	122	BA0	143	VDD	164	NC
102	VDD	123	A11	144	DQ52	165	SA0
103	DQ46	124	VDD	145	NC	166	SA1
104	DQ47	125	DNU	146	NC	167	SA2
105	CB4	126	NC/A12 ¹	147	NC	168	VDD

NOTE:

1. Pin 126 is NC for 32MB and 64MB modules, or A12 for the 128MB module.

Figure 2: Pin Locations (168-Pin DIMM)

Table 6: PIN Descriptions

Pins may not correlate with symbols; refer to Pin Assignment tables on page 3 for more information

PIN NUMBERS	SYMBOL	TYPE	DESCRIPTION
27, 111, 115	RAS#, CAS#, WE#,	Input	Command Inputs: RAS#, CAS#, and WE# (along with S#) define the command being entered.
42, 79	CK0, CK2	Input	Clock: CK is driven by the system clock. All SDRAM input signals are sampled on the positive edge of CK. CK also increments the internal burst counter and controls the output registers.
128	CKE0	Input	Clock Enable: CKE activates (HIGH) and deactivates (LOW) the CK signal. Deactivating the clock provides PRECHARGE POWER-DOWN and SELF REFRESH operation (all device banks idle) or CLOCK SUSPEND OPERATION (burst access in progress). CKE is synchronous except after the device enters power-down and self refresh modes, where CKE becomes asynchronous until after exiting the same mode. The input buffers, including CK, are disabled during power-down and self refresh modes, providing low standby power.
30, 45	S0#, S2#	Input	Chip Select: S# enables (registered LOW) and disables (registered HIGH) the command decoder. All commands are masked when S# is registered HIGH. S# is considered part of the command code.
28, 29, 46, 47, 112, 113, 130, 131	DQMB0–DQMB7	Input	Input/Output Mask: DQMB is an input mask signal for write accesses and an output enable signal for read accesses. Input data is masked when DQMB is sampled HIGH during a WRITE cycle. The output buffers are placed in a High-Z state (two-clock latency) when DQMB is sampled HIGH during a READ cycle.
39, 122	BA0, BA1	Input	Bank Address: BA0 and BA1 define to which device bank the ACTIVE, READ, WRITE, or PRECHARGE command is being applied.
33–38, 117–121, 123, 126 (128MB)	A0–A11 (32MB/64MB) A0–A12 (128MB)	Input	Address Inputs: Provide the row address for ACTIVE commands, and the column address and auto prcharge bit (A10) for READ/WRITE commands, to select one location out of the memory array in the respective device bank. A10 sampled during a PRECHARGE command determines whether the PRECHARGE applies to one device bank (A10 LOW – device bank selected by BA0, BA1) or all device banks (A10 HIGH). The address inputs also provide the op-code during a MODE REGISTER SET command.
83	SCL	Input	Serial Clock for Presence-Detect: SCL is used to synchronize the presence-detect data transfer to and from the module.
165–167	SA0–SA2	Input	Presence-Detect Address Inputs: These pins are used to configure the presence-detect device.
82	SDA	Input/Output	Serial Presence-Detect Data: SDA is a bidirectional pin used to transfer addresses and data into and out of the presence-detect portion of the module.
2–5, 7–11, 13–17, 19–20, 55–58, 60, 65–67, 69–72, 74–77, 86–89, 91–95, 97–101, 103–104, 139–142, 144, 149–151, 153–156, 158–161	DQ0–DQ63	Input/Output	Data I/Os: Data bus.

Table 6: PIN Descriptions

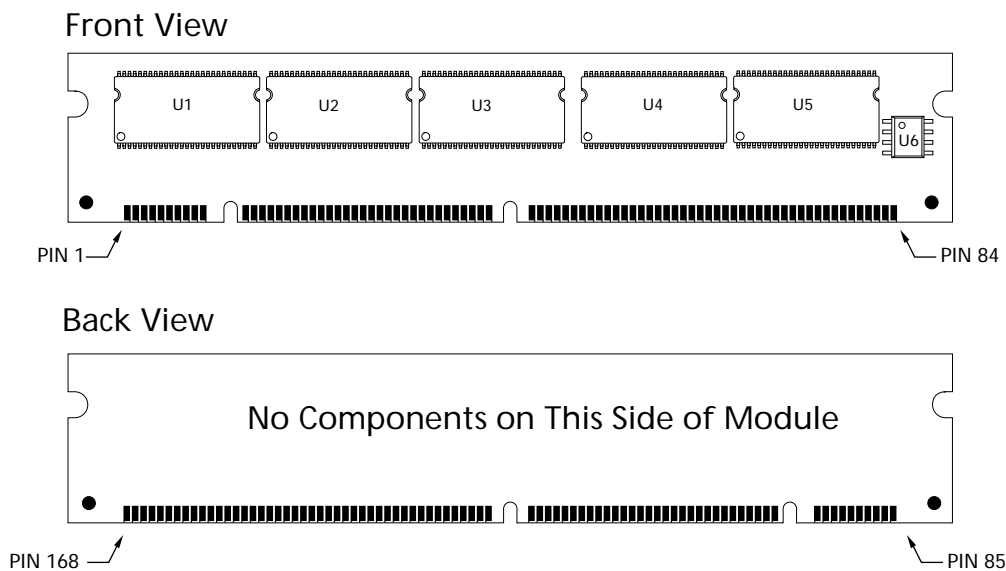
Pins may not correlate with symbols; refer to Pin Assignment tables on page 3 for more information

PIN NUMBERS	SYMBOL	TYPE	DESCRIPTION
21, 22, 52, 53, 105, 106, 136, 137	CB0–CB7	Input/Output	ECC check bits.
6, 18, 26, 40, 41, 49, 59, 73, 84, 90, 102, 110, 124, 133, 143, 157, 168	VDD	Supply	Power Supply: +3.3V ±0.3V.
1, 12, 23, 32, 43, 54, 64, 68, 78, 85, 96, 107, 116, 127, 138, 148, 152, 162	VSS	Supply	Ground.
114, 125, 129, 132, 163	DNU	–	Do Not Use: These pins are not used on these modules, but are assigned pins on other modules in this product family.
24, 25, 31, 44, 48, 50, 51, 61, 62, 63, 80, 81, 108, 109, 126 (32MB/64MB), 134, 135, 145–147, 164	NC	–	Not Connected: These pins are not connected on these modules.

Figure 3: Functional Block Diagram

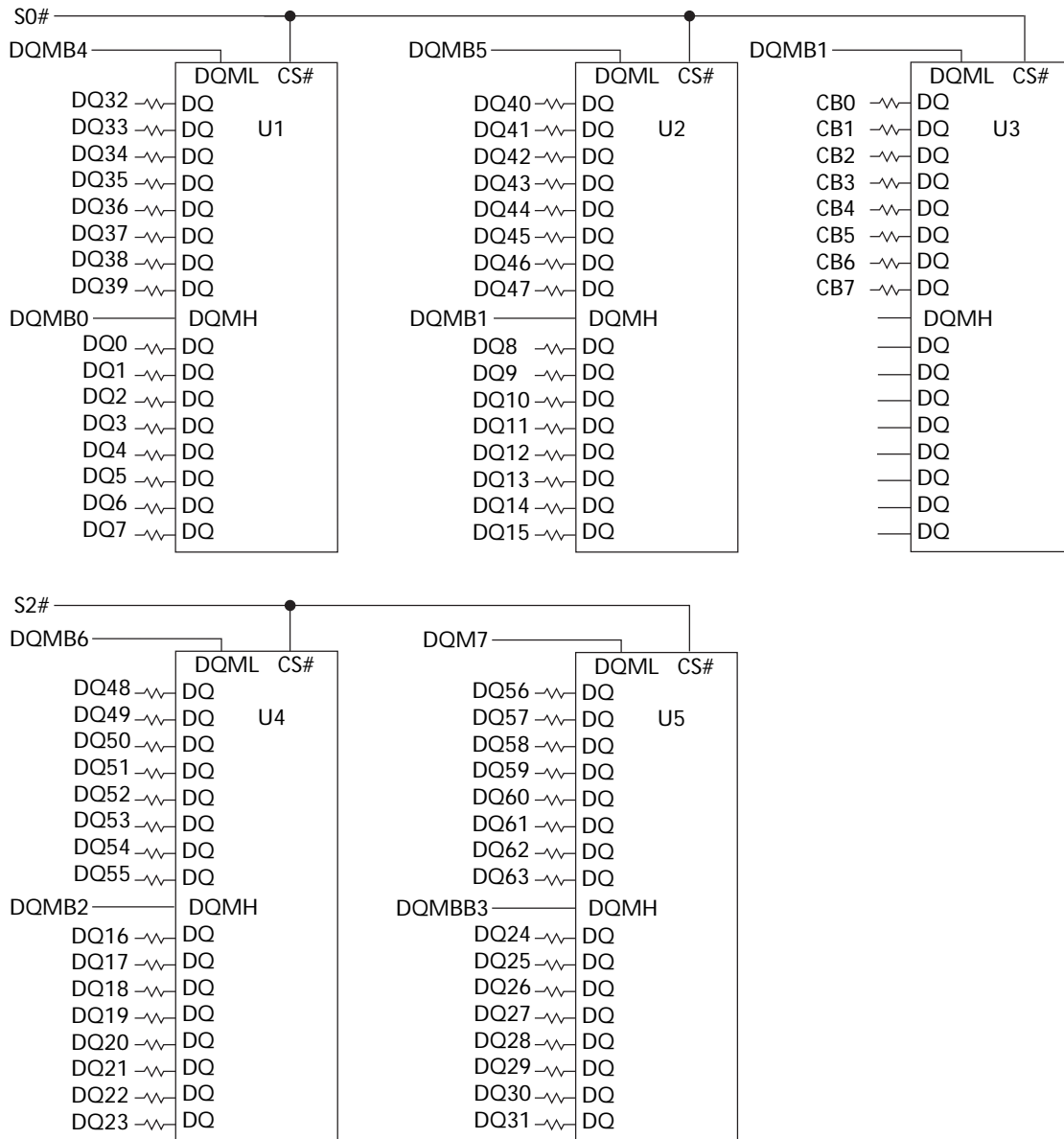

RAS# → RAS#: SDRAMs
 CAS# → CAS#: SDRAMs
 CKE0 → CKE: SDRAMs
 WE# → WE#: SDRAMs
 A0-A11(32MB/64MB) → A0-A11: SDRAMs
 A0-A12(128MB) → A0-A12: SDRAMs
 BA0-1 → BA0-1: SDRAMs

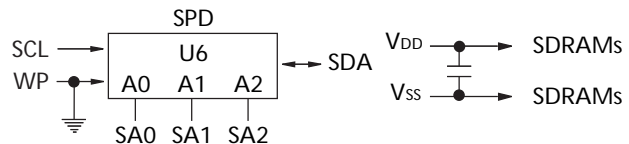
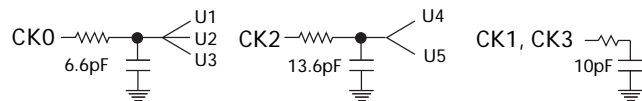

Note:

- All resistor values are 10Ω unless otherwise specified.
- Per industry standard, Micron modules use various component speed grades as referenced in the module part numbering guide at www.micron.com/numberguide.

Standard modules use the following SDRAM devices:
 MT48LC4M16A2TG (32MB); MT48LC8M16A2TG (64MB);
 MT48LC16M16A2TG (128MB)

Lead-free modules use the following SDRAM devices:
 MT48LC4M16A2P (32MB); MT48LC8M16A2P (64MB); MT48LC16M16A2P (128MB)

General Description

The Micron® MT5LSDT472A, MT5LSDT872A(I), and MT5LSDT1672A(I) are a high-speed CMOS, dynamic random-access, 32MB, 64MB, and 128MB memory modules organized in a x72, ECC configuration. ECC functions to detect and correct one-bit memory errors. These module use SDRAM devices which are internally configured as quad-bank DRAMs with a synchronous interface (all signals are registered on the positive edge of the clock signals CK0, CK2).

Read and write accesses to the SDRAM module are burst oriented; accesses start at a selected location and continue for a programmed number of locations in a programmed sequence. Accesses begin with the registration of an ACTIVE command, which is then followed by a READ or WRITE command. The address bits registered coincident with the ACTIVE command are used to select the device bank and row to be accessed (BA0, BA1 select the device bank, A0–A11 for 32MB and 64MB; A0–A12 for 128MB select the device row). The address bits registered coincident with the READ or WRITE command (A0–A7 32MB; A0–A8 64MB and 128MB) are used to select the starting device column location for the burst access.

These modules provide for programmable READ or WRITE burst lengths of 1, 2, 4, or 8 locations, or the full page, with a burst terminate option. An auto precharge function may be enabled to provide a self-timed row precharge that is initiated at the end of the burst sequence. These modules use an internal pipelined architecture to achieve high-speed operation. This architecture is compatible with the $2n$ rule of prefetch architectures, but it also allows the column address to be changed on every clock cycle to achieve a high-speed, fully random access. Precharging one device bank while accessing one of the other three device banks will hide the PRECHARGE cycles and provide seamless, high-speed, random access operation.

These modules are designed to operate in 3.3V, low-power memory systems. An auto refresh mode is provided, along with a power-saving, power-down mode. All inputs, outputs, and clocks are LVTTTL-compatible.

SDRAM modules offer substantial advances in DRAM operating performance, including the ability to synchronously burst data at a high data rate with automatic column-address generation, the ability to interleave between internal banks in order to hide precharge time, and the capability to randomly change column addresses on each clock cycle during a burst access. For more information regarding SDRAM operation, refer to the 64Mb, 128Mb, or 256Mb SDRAM component data sheets.

Serial Presence-Detect Operation

These modules incorporate serial presence-detect (SPD). The SPD function is implemented using a 2,048-bit EEPROM. This nonvolatile storage device contains 256 bytes. The first 128 bytes can be programmed by Micron to identify the module type and various SDRAM organizations and timing parameters. The remaining 128 bytes of storage are available for use by the customer. System READ/WRITE operations between the master (system logic) and the slave EEPROM device (DIMM) occur via a standard IIC bus using the DIMM's SCL (clock) and SDA (data) signals. Write protect (WP) is tied to ground on the module, permanently disabling hardware write protect.

Initialization

SDRAMs must be powered up and initialized in a predefined manner. Operational procedures other than those specified may result in undefined operation. Once power is applied to VDD and VDDQ (simultaneously) and the clock is stable (stable clock is defined as a signal cycling within timing constraints specified for the clock pin), the SDRAM requires a 100 μ s delay prior to issuing any command other than a COMMAND INHIBIT or NOP. Starting at some point during this 100 μ s period and continuing at least through the end of this period, COMMAND INHIBIT or NOP commands should be applied.

Once the 100 μ s delay has been satisfied with at least one COMMAND INHIBIT or NOP command having been applied, a PRECHARGE command should be applied. All device banks must then be precharged, thereby placing the device in the all banks idle state.

Once in the idle state, two AUTO REFRESH cycles must be performed. After the AUTO REFRESH cycles are complete, the SDRAM is ready for mode register programming. Because the mode register will power up in an unknown state, it should be loaded prior to applying any operational command.

Mode Register Definition

The mode register is used to define the specific mode of operation of the SDRAM. This definition includes the selection of a burst length, a burst type, a CAS latency, an operating mode, and a write burst mode, as shown in the Mode Register Definition Diagram. The mode register is programmed via the LOAD MODE REGISTER command and will retain the stored information until it is programmed again or the device loses power.

Mode register bits M0–M2 specify the burst length, M3 specifies the type of burst (sequential or interleaved), M4–M6 specify the CAS latency, M7 and M8 specify the operating mode, M9 specifies the write burst mode, and M10 and M11 are reserved for future use. For the 128MB module, Address A12 (M12) is undefined but should be driven LOW during loading of the mode register.

The mode register must be loaded when all device banks are idle, and the controller must wait the specified time before initiating the subsequent operation. Violating either of these requirements will result in unspecified operation.

Burst Length

Read and write accesses to the SDRAM are burst oriented, with the burst length being programmable, as shown in Figure 4, Mode Register Definition Diagram, on page 8. The burst length determines the maximum number of column locations that can be accessed for a given READ or WRITE command. Burst lengths of 1, 2, 4, or 8 locations are available for both the sequential and the interleaved burst types, and a full-page burst is available for the sequential type. The full-page burst is used in conjunction with the BURST TERMINATE command to generate arbitrary burst lengths.

Reserved states should not be used, as unknown operation or incompatibility with future versions may result.

When a READ or WRITE command is issued, a block of columns equal to the burst length is effectively selected. All accesses for that burst take place within this block, meaning that the burst will wrap within the block if a boundary is reached, as shown in Table 7, Burst Definition Table, on page 9. The block is uniquely selected by A1–Ai when the burst length is set to two; by A2–Ai when the burst length is set to four; and by A3–Ai when the burst length is set to eight. See note 8 of Table 7, Burst Definition Table, on page 9 for Ai values. The remaining (least significant) address bit(s) is (are) used to select the starting location within the block. Full-page bursts wrap within the page if the boundary is reached, as shown in Table 7, Burst Definition Table, on page 9.

Burst Type

Accesses within a given burst may be programmed to be either sequential or interleaved; this is referred to as the burst type and is selected via bit M3.

The ordering of accesses within a burst is determined by the burst length, the burst type and the starting column address, as shown in Table 7, Burst Definition Table, on page 9.

Figure 4: Mode Register Definition Diagram

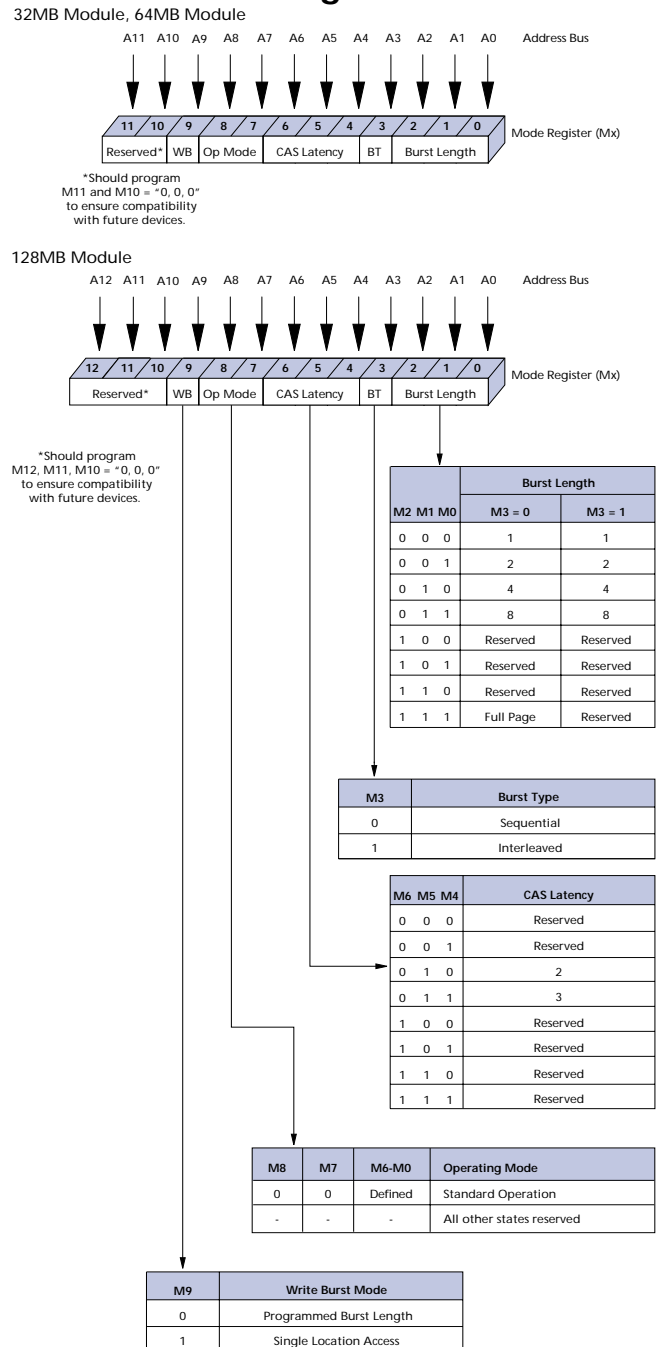
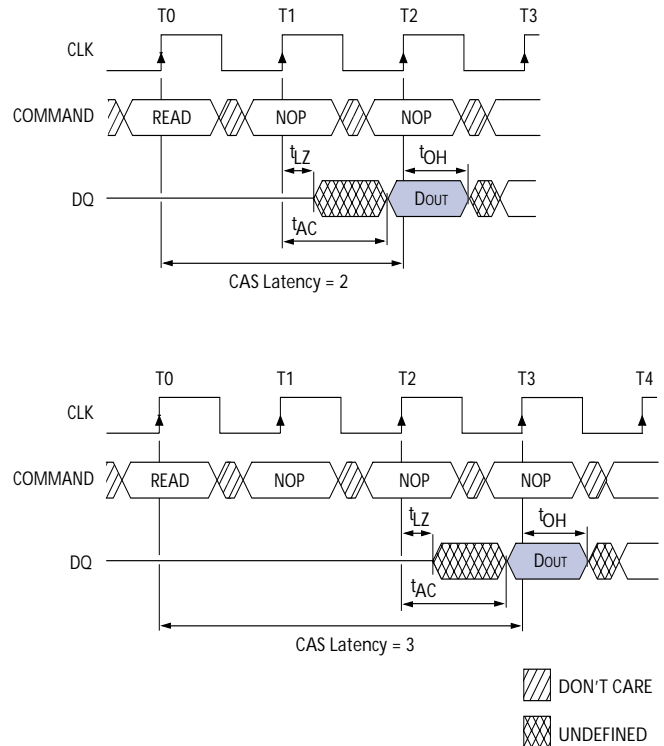

Table 7: Burst Definition Table

BURST LENGTH	STARTING COLUMN ADDRESS	ORDER OF ACCESSES WITHIN A BURST	
		TYPE = SEQUENTIAL	TYPE = INTERLEAVED
2	A0 0 1	0-1	0-1
		1-0	1-0
4	A1 A0 0 0 0 1 1 0 1 1	0-1-2-3	0-1-2-3
		1-2-3-0	1-0-3-2
		2-3-0-1	2-3-0-1
		3-0-1-2	3-2-1-0
8	A2 A1 A0 0 0 0 0 0 1 0 1 0 0 1 1 1 0 0 1 0 1 1 1 0 1 1 1	0-1-2-3-4-5-6-7	0-1-2-3-4-5-6-7
		1-2-3-4-5-6-7-0	1-0-3-2-5-4-7-6
		2-3-4-5-6-7-0-1	2-3-0-1-6-7-4-5
		3-4-5-6-7-0-1-2	3-4-5-6-7-0-1-2-
		4-5-6-7-0-1-2-3	4-5-6-7-0-1-2-3
		5-6-7-0-1-2-3-4	5-4-7-6-1-0-3-2
		6-7-0-1-2-3-4-5	6-7-4-5-2-3-0-1
		7-0-1-2-3-4-5-6	7-6-5-4-3-2-1-0
Full Page (y)	n = A0-Ai (location 0-y)	Cn, Cn + 1, Cn + 2, Cn + 3, Cn + 4... Cn - 1, Cn...	Not supported

NOTE:

- For full-page accesses: y = 256 (32MB); y = 512 (64MB/128MB).
- For a burst length of two, A1-Ai select the block-of-two burst; A0 selects the starting column within the block.
- For a burst length of four, A2-Ai select the block-of-four burst; A-A1 select the starting column within the block.
- For a burst length of eight, A3-Ai select the block-of-eight burst; A0-A2 select the starting column within the block.
- For a full-page burst, the full row is selected and A0-Ai select the starting column.
- Whenever a boundary of the block is reached within a given sequence above, the following access wraps within the block.
- For a burst length of one, A0-Ai select the unique column to be accessed, and mode register bit M3 is ignored.
- i = 7 for 32MB module
i = 8 for 64MB and 128MB modules

Figure 5: CAS Latency Diagram

CAS Latency

The CAS latency is the delay, in clock cycles, between the registration of a READ command and the availability of the first piece of output data. The latency can be set to two or three clocks.

If a READ command is registered at clock edge n , and the latency is m clocks, the data will be available by clock edge $n + m$. The DQ will start driving as a result of the clock edge one cycle earlier ($n + m - 1$), and provided that the relevant access times are met, the data will be valid by clock edge $n + m$. For example, assuming that the clock cycle time is such that all relevant access times are met, if a READ command is registered at T0 and the latency is programmed to two clocks, the DQ will start driving after T1 and the data will be valid by T2, as shown in Figure 5, CAS Latency Diagram, on page 9. The CAS Latency Table indicates the operating frequencies at which each CAS latency setting can be used.

Reserved states should not be used as unknown operation or incompatibility with future versions may result.

Operating Mode

The normal operating mode is selected by setting M7 and M8 to zero; the other combinations of values for M7 and M8 are reserved for future use and/or test modes. The programmed burst length applies to both READ and WRITE bursts.

Test modes and reserved states should not be used because unknown operation or incompatibility with future versions may result.

Write Burst Mode

When M9 = 0, the burst length programmed via M0-M2 applies to both READ and WRITE bursts; when M9

= 1, the programmed burst length applies to READ bursts, but write accesses are single-location (non-burst) accesses.

Table 8: CAS Latency Table

SPEED	ALLOWABLE OPERATING CLOCK FREQUENCY (MHz)	
	CAS LATENCY = 2	CAS LATENCY = 3
-13E	≤ 133	≤ 143
-133	≤ 100	≤ 133
-10E	≤ 100	N/A

Commands

Table 9, Commands and DQMB Operation Truth Table, provides a general reference of available commands. For a more detailed description of commands

and operations, refer to the 64Mb, 128Mb, or 256Mb SDRAM component data sheet.

Table 9: Commands and DQMB Operation Truth Table

CKE is HIGH for all commands shown except SELF REFRESH

NAME (FUNCTION)	S#	RAS#	CAS#	WE#	DQMB	ADDR	DQS	NOTES
COMMAND INHIBIT (NOP)	H	X	X	X	X	X	X	
NO OPERATION (NOP)	L	H	H	H	X	X	X	
ACTIVE (Select bank and activate row)	L	L	H	H	X	Bank/Row	X	2
READ (Select bank and column, and start READ burst)	L	H	L	H	L/H ⁸	Bank/Col	X	3
WRITE (Select bank and column, and start WRITE burst)	L	H	L	L	L/H ⁸	Bank/Col	Valid	3
BURST TERMINATE	L	H	H	L	X	X	Active	
PRECHARGE (Deactivate row in bank or banks)	L	L	H	L	X	Code	X	4
AUTO REFRESH or SELF REFRESH (Enter self refresh mode)	L	L	L	H	X	X	X	5, 6
LOAD MODE REGISTER	L	L	L	L	X	Op-Code	X	1
Write Enable/Output enable	-	-	-	-	L	-	Active	7
Write Inhibit/Output High-Z	-	-	-	-	H	-	High-Z	7

NOTE:

- A0–A11 define the op-code written to the mode register, and for the 128MB module, A12 should be driven LOW.
- A0–A11 (32MB and 64MB) or A0–A12 (128MB) provide device row address, and BA0, BA1 determine which device bank is made active.
- A0–A7 (32MB) or A0–A8 (64MB and 128MB) provide device column address; A10 HIGH enables the auto precharge feature (nonpersistent), while A10 LOW disables the auto precharge feature; BA0, BA1 determine which device bank is being read from or written to.
- A10 LOW: BA0, BA1 determine the device bank being precharged. A10 HIGH: All device banks precharged and BA0, BA1 are “Don’t Care.”
- This command is AUTO REFRESH if CKE is HIGH, SELF REFRESH if CKE is LOW.
- Internal refresh counter controls device row addressing; all inputs and I/Os are “Don’t Care” except for CKE.
- Activates or deactivates the DQ during WRITES (zero-clock delay) and READs (two-clock delay).

Absolute Maximum Ratings

Stresses greater than those listed may cause permanent damage to the device. This is a stress rating only, and functional operation of the device at these or any other conditions above those indicated in the opera-

tional sections of this specification is not implied. Exposure to absolute maximum rating conditions for extended periods may affect reliability.

Voltage on VDD, VDDQ Supply
Relative to VSS -1V to +4.6V
Voltage on Inputs, NC or I/O Pins
Relative to VSS -1V to +4.6V

Operating Temperature
T_{OPR} (Commercial - ambient) 0°C to +65°C
T_{OPR} (Industrial - ambient) -40°C to +85°C
Storage Temperature (plastic) -55°C to +150°C

Table 10: DC Electrical Characteristics and Operating Conditions

Notes: 1, 5, 6; notes appear following the parameter tables; VDD, VDDQ = +3.3V ±0.3V

PARAMETER/CONDITION	SYMBOL	MIN	MAX	UNITS	NOTES	
SUPPLY VOLTAGE	VDD, VDDQ	3	3.6	V		
INPUT HIGH VOLTAGE: Logic 1; All inputs	V _{IH}	2	VDD + 0.3	V	22	
INPUT LOW VOLTAGE: Logic 0; All inputs	V _{IL}	-0.3	0.8	V	22	
INPUT LEAKAGE CURRENT: Any input 0V ≤ V _{IN} ≤ VDD (All other pins not under test = 0V)	Command/ Address, CKE	-25	25	μA	33	
	CK, S0#	-15	15			
	CK2, S2#	-10	10			
	DQMB	-5	5			
OUTPUT LEAKAGE CURRENT: DQs are disabled; 0V ≤ V _{OUT} ≤ VDDQ	DQ	I _{OZ}	-5	5	μA	33
OUTPUT LEVELS: Output High Voltage (I _{OUT} = -4mA)	V _{OH}	2.4	-	V		
Output Low Voltage (I _{OUT} = 4mA)	V _{OL}	-	0.4	V		

Table 11: IDD Specifications and Conditions – 32MB

Notes: 1, 5, 6, 11, 13; notes appear following the parameter tables; VDD, VDDQ = +3.3V ±0.3V; DRAM components only

PARAMETER/CONDITION	SYMBOL	MAX			UNITS	NOTES
		-13E	-133	-10E		
OPERATING CURRENT: Active Mode; Burst = 2; READ or WRITE; t _{RC} = t _{RC} (MIN)	IDD1	625	575	475	mA	3, 18, 19, 29
STANDBY CURRENT: Power-Down Mode; All device banks idle; CKE = LOW	IDD2	10	10	10	mA	29
STANDBY CURRENT: Active Mode; CKE = HIGH; CS# = HIGH; All device banks active after t _{RCD} met; No accesses in progress	IDD3	225	225	175	mA	3, 12, 19, 29
OPERATING CURRENT: Burst Mode; Continuous burst; READ or WRITE; All device banks active	IDD4	750	700	600	mA	3, 18, 19, 29
AUTO REFRESH CURRENT CS# = HIGH; CKE = HIGH	t _{RFC} = t _{RFC} (MIN)	1,150	1,050	950	mA	3, 12, 18, 19, 29, 30
	t _{RFC} = 15.62μs	15	15	15	mA	
SELF REFRESH CURRENT: CKE ≤ 0.2V	IDD7	5	5	5	mA	4

Table 12: IDD Specifications and Conditions – 64MB

Notes: 1, 5, 6, 11, 13; notes appear following the parameter tables; VDD, VDDQ = +3.3V ±0.3V; DRAM components only

PARAMETER/CONDITION	SYMBOL	MAX			UNITS	NOTES	
		-13E	-133	-10E			
OPERATING CURRENT: Active Mode; Burst = 2; READ or WRITE; $t_{RC} = t_{RC}(\text{MIN})$	IDD1	800	750	700	mA	3, 18, 19, 29	
STANDBY CURRENT: Power-Down Mode; All device banks idle; CKE = LOW	IDD2	10	10	10	mA	29	
STANDBY CURRENT: Active Mode; CKE = HIGH; CS# = HIGH; All device banks active after t_{RCD} met; No accesses in progress	IDD3	250	250	200	mA	3, 12, 19, 29	
OPERATING CURRENT: Burst Mode; Continuous burst; READ or WRITE; All device banks active	IDD4	825	750	700	mA	3, 18, 19, 29	
AUTO REFRESH CURRENT CS# = HIGH; CKE = HIGH	$t_{RFC} = t_{RFC}(\text{MIN})$	IDD5	1,650	1,550	1,350	mA	3, 12, 18, 19, 29, 30
	$t_{RFC} = 15.62\mu\text{s}$	IDD6	15	15	15	mA	
SELF REFRESH CURRENT: CKE ≤ 0.2V	IDD7	10	10	10	mA	4	

Table 13: IDD Specifications and Conditions – 128MB

Notes: 1, 5, 6, 11, 13; notes appear following the parameter tables; VDD, VDDQ = +3.3V ±0.3V; DRAM components only

PARAMETER/CONDITION	SYMBOL	MAX			UNITS	NOTES	
		-13E	-133	-10E			
OPERATING CURRENT: Active Mode; Burst = 2; READ or WRITE; $t_{RC} = t_{RC}(\text{MIN})$	IDD1	625	625	625	mA	3, 18, 19, 29	
STANDBY CURRENT: Power-Down Mode; All device banks idle; CKE = LOW	IDD2	10	10	10	mA	29	
STANDBY CURRENT: Active Mode; CKE = HIGH; CS# = HIGH; All device banks active after t_{RCD} met; No accesses in progress	IDD3	200	200	200	mA	3, 12, 19, 29	
OPERATING CURRENT: Burst Mode; Continuous burst; READ or WRITE; All device banks active	IDD4	675	675	675	mA	3, 18, 19, 29	
AUTO REFRESH CURRENT CS# = HIGH; CKE = HIGH	$t_{RFC} = t_{RFC}(\text{MIN})$	IDD5	1,425	1,350	1,350	mA	3, 12, 18, 19, 29, 30
	$t_{RFC} = 7.81\mu\text{s}$	IDD6	17.5	17.5	17.5	mA	
SELF REFRESH CURRENT: CKE ≤ 0.2V	IDD7	12.5	12.5	12.5	mA	4	

Table 14: Capacitance

Notes 1, 2; notes appear following parameter table

PARAMETER	SYMBOL	MIN	MAX	UNITS
Input Capacitance: Address and Command, CKE	C11	12.5	19	pF
Input Capacitance: S0#	C12 _a	7.5	11.4	pF
Input Capacitance: S2#	C12 _b	5	7.6	pF
Input Capacitance: CK0	C13 _a	14.1	17.1	pF
Input Capacitance: CK2	C13 _b	18.6	20.6	pF
Input Capacitance: DQMB	C14	2.5	3.8	pF
Input/Output Capacitance: DQ	C10	4	6	pF

Table 15: Electrical Characteristics and Recommended AC Operating Conditions

Notes: 5, 6, 8, 9, 11, 31; notes appear following the parameter tables; VDD, VDDQ = +3.3V ±0.3V

AC CHARACTERISTICS			-13E		-133		-10E			
PARAMETER		SYMBOL	MIN	MAX	MIN	MAX	MIN	MAX	UNITS	NOTES
Access time from CLK (pos. edge)	CL = 3	t _{AC(3)}		5.4		5.4		6	ns	27
	CL = 2	t _{AC(2)}		5.4		6		6	ns	
Address hold time		t _{AH}	0.8		0.8		1		ns	
Address setup time		t _{AS}	1.5		1.5		2		ns	
CLK high-level width		t _{CH}	2.5		2.5		3		ns	
CLK low-level width		t _{CL}	2.5		2.5		3		ns	
Clock cycle time	CL = 3	t _{CK(3)}	7		7.5		8		ns	23
	CL = 2	t _{CK(2)}	7.5		10		10		ns	23
CKE hold time		t _{CKH}	0.8		0.8		1		ns	
CKE setup time		t _{CKS}	1.5		1.5		2		ns	
CS#, RAS#, CAS#, WE#, DQM hold time		t _{CMH}	0.8		0.8		1		ns	
CS#, RAS#, CAS#, WE#, DQM setup time		t _{CMS}	1.5		1.5		2		ns	
Data-in hold time		t _{DH}	0.8		0.8		1		ns	
Data-in setup time		t _{DS}	1.5		1.5		2		ns	
Data-out high-impedance time	CL = 3	t _{HZ(3)}		5.4		5.4		6	ns	10
	CL = 2	t _{HZ(2)}		5.4		6		6	ns	10
Data-out low-impedance time		t _{LZ}	1		1		1		ns	
Data-out hold time (load)		t _{OH}	3		3		3		ns	
Data-out hold time (no load)		t _{OH_N}	1.8		1.8		1.8		ns	28
ACTIVE to PRECHARGE command		t _{RAS}	37	120,000	44	120,000	50	120,000	ns	32
ACTIVE to ACTIVE command period		t _{RC}	60		66		70		ns	
ACTIVE to READ or WRITE delay		t _{RCD}	15		20		20		ns	
Refresh period (8,192 rows)		t _{REF}		64		64		64	ms	
AUTO REFRESH period		t _{RFC}	66		66		70		ns	
PRECHARGE command period		t _{RP}	15		20		20		ns	
ACTIVE bank <i>a</i> to ACTIVE bank <i>b</i> command		t _{R_{RD}}	14		15		20		ns	
Transition time		t _T	0.3	1.2	0.3	1.2	0.3	1.2	ns	7
WRITE recovery time		t _{WR}	1 CLK + 7ns		1 CLK + 7.5ns		1 CLK + 7ns		ns	24
			14		15		15		ns	25
Exit SELF REFRESH to ACTIVE command		t _{XSR}	67		75		80		ns	20

Table 16: AC Functional Characteristics

Notes: 5, 6, 8, 9, 11, 31; notes appear following the parameter tables

PARAMETER	SYMBOL	-13E	-133	-10E	UNITS	NOTES
READ/WRITE command to READ/WRITE command	t_{CCD}	1	1	1	t_{CK}	17
CKE to clock disable or power-down entry mode	t_{CKED}	1	1	1	t_{CK}	14
CKE to clock enable or power-down exit setup mode	t_{PED}	1	1	1	t_{CK}	14
DQM to input data delay	t_{DQD}	0	0	0	t_{CK}	17
DQM to data mask during WRITES	t_{DQM}	0	0	0	t_{CK}	17
DQM to data high-impedance during READS	t_{DQZ}	2	2	2	t_{CK}	17
WRITE command to input data delay	t_{DWD}	0	0	0	t_{CK}	17
Data-in to ACTIVE command	t_{DAL}	4	5	4	t_{CK}	15, 21
Data-into PRECHARGE command	t_{DPL}	2	2	2	t_{CK}	16, 21
Last data-in to burst STOP command	t_{BDL}	1	1	1	t_{CK}	17
Last data-in to new READ/WRITE command	t_{CDL}	1	1	1	t_{CK}	17
Last data-in to PRECHARGE command	t_{RDL}	2	2	2	t_{CK}	16, 21
LOAD MODE REGISTER command to ACTIVE or REFRESH command	t_{MRD}	2	2	2	t_{CK}	26
Data-out to high-impedance from PRECHARGE command	CL = 3	$t_{ROH(3)}$	3	3	t_{CK}	17
	CL = 2	$t_{ROH(2)}$	2	2	t_{CK}	17

Notes

1. All voltages referenced to VSS.
2. This parameter is sampled. VDD, VDDQ = +3.3V; f = 1 MHz; T_A = 25°C; pin under test biased at 1.4V.
3. I_{DD} is dependent on output loading and cycle rates. Specified values are obtained with minimum cycle time and the outputs open.
4. Enables on-chip refresh and address counters.
5. The minimum specifications are used only to indicate cycle time at which proper operation over the full temperature range is ensured (0°C ≤ T_A ≤ +70°C for Commercial, -40°C ≤ T_A ≤ +85°C for Industrial).
6. An initial pause of 100μs is required after power-up, followed by two AUTO REFRESH commands, before proper device operation is ensured. (VDD and VDDQ must be powered up simultaneously. VSS and VSSQ must be at same potential.) The two AUTO REFRESH command wake-ups should be repeated any time the t^{REF} refresh requirement is exceeded.
7. AC characteristics assume t^T = 1ns.
8. In addition to meeting the transition rate specification, the clock and CKE must transit between V_{IH} and V_{IL} (or between V_{IL} and V_{IH}) in a monotonic manner.
9. Outputs measured at 1.5V with equivalent load:

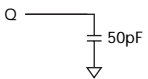
10. t^{HZ} defines the time at which the output achieves the open circuit condition; it is not a reference to V_{OH} or V_{OL}. The last valid data element will meet t^{OH} before going High-Z.
11. AC timing and I_{DD} tests have V_{IL} = 0V and V_{IH} = 3V, with timing referenced to 1.5V crossover point. If the input transition time is longer than 1ns, then the timing is referenced at V_{IL} (MAX) and V_{IH} (MIN) and no longer at the ISV crossover point.
12. Other input signals are allowed to transition no more than once every two clocks and are otherwise at valid V_{IH} or V_{IL} levels.
13. I_{DD} specifications are tested after the device is properly initialized.
14. Timing actually specified by t^{CKS}; clock(s) specified as a reference only at minimum cycle rate.
15. Timing actually specified by t^{WR} plus t^{RP}; clock(s) specified as a reference only at minimum cycle rate.
16. Timing actually specified by t^{WR}.
17. Required clocks are specified by JEDEC functionality and are not dependent on any timing parameter.
18. The I_{DD} current will increase or decrease proportionally according to the amount of frequency alteration for the test condition.
19. Address transitions average one transition every two clocks.
20. CLK must be toggled a minimum of two times during this period.
21. Based on t^{CK} = 10ns for -10E; t^{CK} = 7.5ns for -133 and -13E.
22. V_{IH} overshoot: V_{IH} (MAX) = VDDQ + 2V for a pulse width ≤ 3ns, and the pulse width cannot be greater than one-third of the cycle rate. V_{IL} undershoot: V_{IL} (MIN) = -2V for a pulse width ≤ 3ns.
23. The clock frequency must remain constant (stable clock is defined as a signal cycling within timing constraints specified for the clock pin) during access or precharge states (READ, WRITE, including t^{WR} and PRECHARGE commands). CKE may be used to reduce the data rate.
24. Auto precharge mode only. The precharge timing budget (t^{RP}) begins 7ns for -13E; 7.5ns for -133; and 7ns for -10E after the first clock delay, after the last WRITE is executed. May not exceed limit set for precharge mode.
25. Precharge mode only.
26. JEDEC and PC100 specify three clocks.
27. t^{AC} for -133/-13E at CL = 3 with no load is 4.6ns and is guaranteed by design.
28. Parameter guaranteed by design.
29. For -13E, CL = 2 and t^{CK} = 7.5ns; for -133, CL = 3 and t^{CK} = 7.5ns; for -10E, CL=2 and t^{CK} = 10ns.
30. CKE is HIGH during refresh command period t^{RFC} (MIN), else CKE is LOW. The I_{DD6} limit is actually a nominal value and does not result in a fail value.
31. Refer to device data sheet for timing waveforms.
32. The value of t^{RAS} used in -13E speed grade modules is calculated from t^{RC} - t^{RP}.
33. Leakage number reflects the worst-case leakage possible through the module pin, not what each memory device contributes.

SPD Clock and Data Conventions

Data states on the SDA line can change only during SCL LOW. SDA state changes during SCL HIGH are reserved for indicating start and stop conditions, as indicated in Figure 6, Data Validity, and Figure 7, Definition of Start and Stop.

SPD Start Condition

All commands are preceded by the start condition, which is a HIGH-to-LOW transition of SDA when SCL is HIGH. The SPD device continuously monitors the SDA and SCL lines for the start condition and will not respond to any command until this condition has been met.

SPD Stop Condition

All communications are terminated by a stop condition, which is a LOW-to-HIGH transition of SDA when SCL is HIGH. The stop condition is also used to place the SPD device into standby power mode.

SPD Acknowledge

Acknowledge is a software convention used to indicate successful data transfers. The transmitting device, either master or slave, will release the bus after transmitting eight bits. During the ninth clock cycle, the receiver will pull the SDA line LOW to acknowledge that it received the eight bits of data as indicated in Figure 8, Acknowledge Response from Receiver, on page 17.

The SPD device will always respond with an acknowledge after recognition of a start condition and its slave address. If both the device and a WRITE operation have been selected, the SPD device will respond with an acknowledge after the receipt of each subsequent eight-bit word. In the read mode, the SPD device will transmit eight bits of data, release the SDA line, and monitor the line for an acknowledge. If an acknowledge is detected and no stop condition is generated by the master, the slave will continue to transmit data. If an acknowledge is not detected, the slave will terminate further data transmissions and await the stop condition to return to standby power mode.

Figure 6: Data Validity

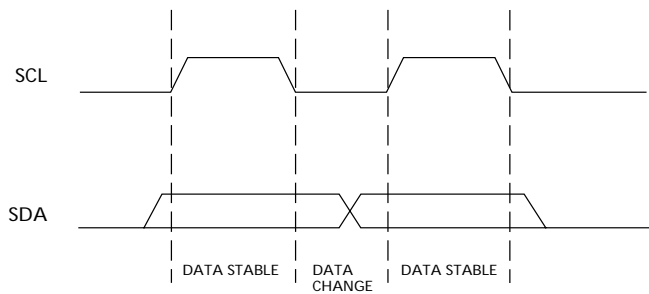

Figure 7: Definition of Start and Stop

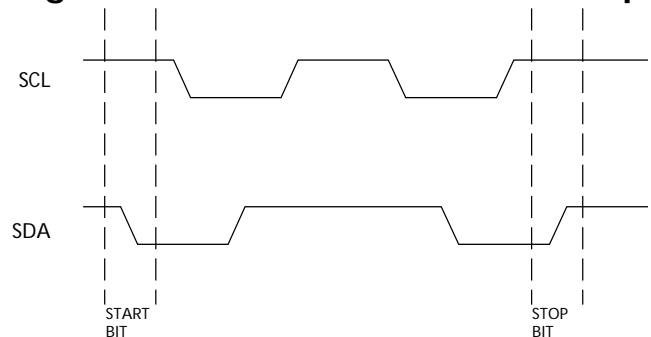

Figure 8: Acknowledge Response from Receiver

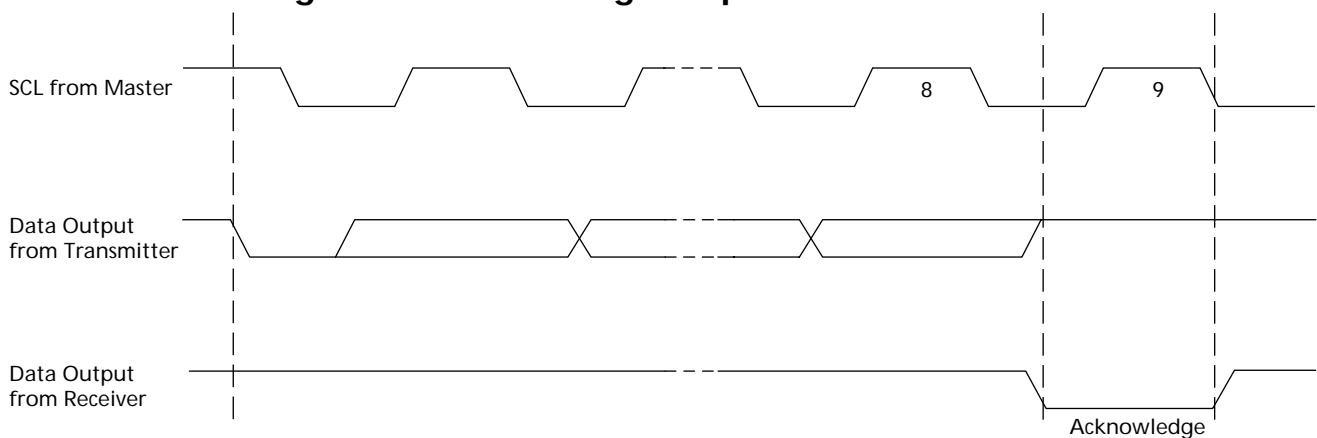

Table 17: EEPROM Device Select Code

The most significant bit (b7) is sent first

	DEVICE TYPE IDENTIFIER				CHIP ENABLE			\overline{RW}
	b7	b6	b5	b4	b3	b2	b1	b0
Memory Area Select Code (two arrays)	1	0	1	0	SA2	SA1	SA0	\overline{RW}
Protection Register Select Code	0	1	1	0	SA2	SA1	SA0	\overline{RW}

Table 18: EEPROM Operating Modes

MODE	\overline{RW} BIT	\overline{WC}	BYTES	INITIAL SEQUENCE
Current Address Read	1	V _{IH} or V _{IL}	1	START, Device Select, $\overline{RW} = '1'$
Random Address Read	0	V _{IH} or V _{IL}	1	START, Device Select, $\overline{RW} = '0'$, Address
	1	V _{IH} or V _{IL}	1	reSTART, Device Select, $\overline{RW} = '1'$
Sequential Read	1	V _{IH} or V _{IL}	≥ 1	Similar to Current or Random Address Read
Byte Write	0	V _{IL}	1	START, Device Select, $\overline{RW} = '0'$
Page Write	0	V _{IL}	≤ 16	START, Device Select, $\overline{RW} = '0'$

Figure 9: SPD EEPROM Timing Diagram

Table 19: Serial Presence-Detect EEPROM DC Operating Conditions

All voltages referenced to VSS; VDDSPD = +2.3V to +3.6V

PARAMETER/CONDITION	SYMBOL	MIN	MAX	UNITS
SUPPLY VOLTAGE	VDD	3	3.6	V
INPUT HIGH VOLTAGE: Logic 1; All inputs	V _{IH}	VDD x 0.7	VDD + 0.5	V
INPUT LOW VOLTAGE: Logic 0; All inputs	V _{IL}	-1	VDD x 0.3	V
OUTPUT LOW VOLTAGE: I _{OUTL} = 3mA	V _{OL}	-	0.4	V
INPUT LEAKAGE CURRENT: V _{IN} = GND to VDD	I _{LI}	-	10	μA
OUTPUT LEAKAGE CURRENT: V _{OUT} = GND to VDD	I _{LO}	-	10	μA
STANDBY CURRENT: SCL = SDA = VDD - 0.3V; All other inputs = GND or 3.3V ±10%	I _{SB}	-	30	μA
POWER SUPPLY CURRENT: SCL clock frequency = 100 KHz	I _{DD}	-	2	mA

Table 20: Serial Presence-Detect EEPROM AC Operating Conditions

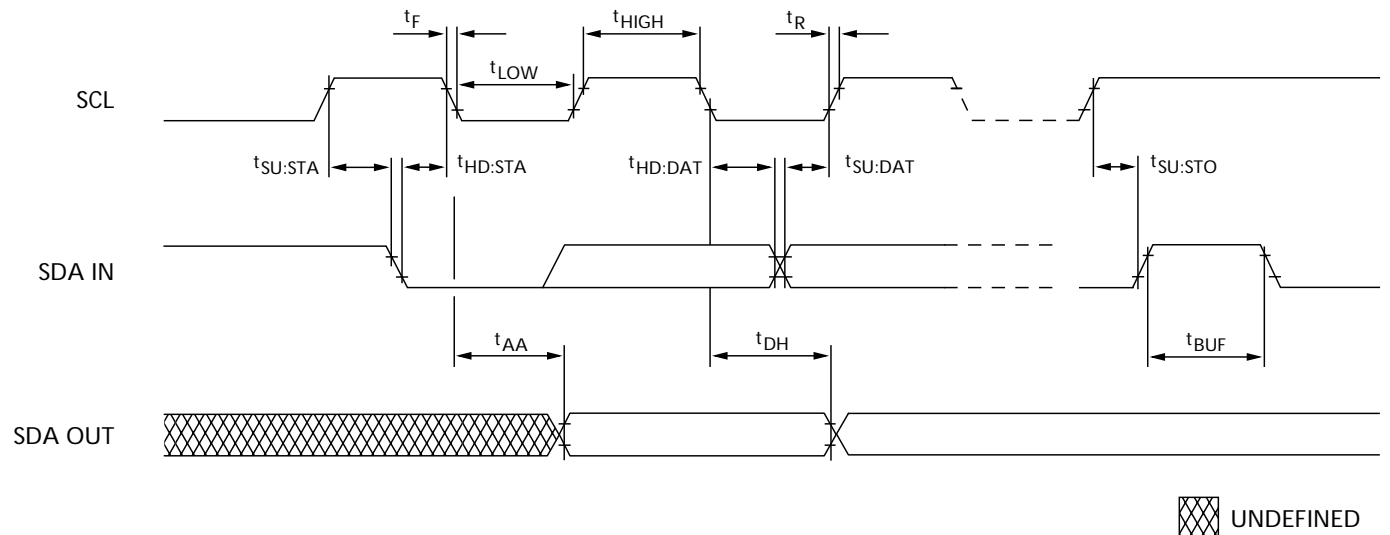
All voltages referenced to VSS; VDDSPD = +2.3V to +3.6V

PARAMETER/CONDITION	SYMBOL	MIN	MAX	UNITS	NOTES
SCL LOW to SDA data-out valid	t _{AA}	0.2	0.9	μs	1
Time the bus must be free before a new transition can start	t _{BUF}	1.3		μs	
Data-out hold time	t _{DH}	200		ns	
SDA and SCL fall time	t _F		300	ns	2
Data-in hold time	t _{HD:DAT}	0		μs	
Start condition hold time	t _{HD:STA}	0.6		μs	
Clock HIGH period	t _{HIGH}	0.6		μs	
Noise suppression time constant at SCL, SDA inputs	t _I		50	ns	
Clock LOW period	t _{LOW}	1.3		μs	
SDA and SCL rise time	t _R		0.3	μs	2
SCL clock frequency	f _{SCL}		400	KHz	
Data-in setup time	t _{SU:DAT}	100		ns	
Start condition setup time	t _{SU:STA}	0.6		μs	3
Stop condition setup time	t _{SU:STO}	0.6		μs	
WRITE cycle time	t _{WRC}		10	ms	4

NOTE:

1. To avoid spurious START and STOP conditions, a minimum delay is placed between SCL = 1 and the falling or rising edge of SDA.
2. This parameter is sampled.
3. For a reSTART condition, or following a WRITE cycle.
4. The SPD EEPROM WRITE cycle time (t_{WRC}) is the time from a valid stop condition of a write sequence to the end of the EEPROM internal erase/program cycle. During the WRITE cycle, the EEPROM bus interface circuit is disabled, SDA remains HIGH due to pull-up resistor, and the EEPROM does not respond to its slave address.

Table 21: Serial Presence-Detect Matrix

"1"/"0": Serial Data, "driven to HIGH"/"driven to LOW."

BYTE	DESCRIPTION	ENTRY (VERSION)	MT5LSDT472A	MT5LSDT872A(I)	MT5LSDT1672A(I)
0	Number of Bytes Used By Micron	128	80	80	80
1	Total Number of Spd Memory Bytes	256	08	08	08
2	Memory Type	SDRAM	04	04	04
3	Number of Row Addresses	12 or 13	0C	0C	0D
4	Number of Column Addresses	8 or 9	08	09	09
5	Number of Banks	1	01	01	01
6	Module Data Width	72	48	48	48
7	Module Data Width (Continued)	0	00	00	00
8	Module Voltage Interface Levels	LVTTL	01	01	01
9	SDRAM Cycle Time, ^t CK (CAS Latency = 3)	7ns (-13E) 7.5ns (-133) 8ns (-10E)	70 75 80	70 75 80	70 75 80
10	SDRAM Access from Clock, ^t AC (CAS Latency = 3)	5.4ns (-13E/-133) 6ns (-10E)	54 60	54 60	54 60
11	Module Configuration Type	ECC	02	02	02
12	Refresh Rate/Type	(80) 15.6µs/SELF (82) 7.81µs/SELF	80	80	82
13	SDRAM Width (Primary SDRAM)	16	10	10	10
14	Error-checking SDRAM Data Width	16	10	10	10
15	Minimum Clock Delay, ^t CCD	1	01	01	01
16	Burst Lengths Supported	1, 2, 4, 8, PAGE	8F	8F	8F
17	Number of Internal Banks on SDRAM Device	4	04	04	04
18	CAS Latencies Supported	2, 3	06	06	06
19	CS Latency	0	01	01	01
20	WE Latency	0	01	01	01
21	SDRAM Module Attributes	UNBUFFERED	00	00	00
22	SDRAM Device Attributes: General	0E	0E	0E	0E
23	SDRAM Cycle Time, ^t CK (CAS Latency = 2)	7.5ns (-13E) 10ns (-133/-10E)	75 A0	75 A0	75 A0
24	SDRAM Access from Clock, ^t AC (CAS Latency = 2)	5.4ns (-13E) 6ns (-133/-10E)	54 60	54 60	54 60
25	SDRAM Cycle Time, ^t CK (CAS Latency = 1)	-	00	00	00
26	SDRAM Access from Clock, ^t AC (CAS Latency = 1)	-	00	00	00
27	Minimum Row Precharge Time, ^t RP	15ns (-13E) 20ns (-133/-10E)	0F 14	0F 14	0F 14
28	Minimum Row Active to Row Active, ^t R RD	14ns (-13E) 15ns (-133) 20ns (-10E)	0E 0F 14	0E 0F 14	0E 0F 14
29	Minimum RAS# to CAS# Delay, ^t R CD	15ns (-13E) 20ns (-133/-10E)	0F 14	0F 14	0F 14

Table 21: Serial Presence-Detect Matrix

"1"/"0": Serial Data, "driven to HIGH"/"driven to LOW."

BYTE	DESCRIPTION	ENTRY (VERSION)	MT5LSDT472A	MT5LSDT872A(I)	MT5LSDT1672A(I)
30	Minimum RAS# Pulse Width, ^t RAS (Note 1)	45ns (-13E) 44ns (-133) 50ns (-10E)	2D 2C 32	2D 2C 32	2D 2C 32
31	Module Rank Density	32MB, 64MB, or 128MB	08	10	20
32	Command and Address Setup Time	1.5ns (-13E/-133) 2ns (-10E)	15 20	15 20	15 20
33	Command and Address Hold Time	0.8ns (-13E/-133) 1ns (-10E)	08 10	08 10	08 10
34	Data Signal Input Setup Time	1.5ns (-13E/-133) 2ns (-10E)	15 20	15 20	15 20
35	Data Signal Input Hold Time	0.8ns (-13E/-133) 1ns (-10E)	08 10	08 10	08 10
36-40	Reserved		00	00	00
41	Device Minimum Active/Auto-refresh Time, ^t RC	60ns (-13E) 66ns (-133) 70ns (10E)	3C 42 46	3C 42 46	3C 42 46
42-61	Reserved		00	00	00
62	SPD Revision	2.0	02	20	20
63	Checksum for Bytes 0-62	-13E -133 -10E	9C E8 34	A5 F1 3D	B8 04 50
64	Manufacturer's JEDEC ID Code	MICRON	2C	2C	2C
65-71	Manufacturer's JEDEC ID Code (Continued)		FF	FF	FF
72	Manufacturing Location	1-12	01-0C	01-0C	01-0C
73-90	Module Part Number (ASCII)		Variable Data	Variable Data	Variable Data
91	PCB Identification Code	1-9	01-09	01-09	01-09
92	Identification Code (Continued)	0	00	00	00
93	Year of Manufacture in BCD		Variable Data	Variable Data	Variable Data
94	Week of Manufacture in BCD		Variable Data	Variable Data	Variable Data
95-98	Module Serial Number		Variable Data	Variable Data	Variable Data
99-125	Manufacturer-Specific Data (RSVD)		Variable Data	Variable Data	Variable Data
126	System Frequency	100/133 MHz	64	64	64
127	SDRAM Component And Clock Detail		AF	AF	AF

NOTE:

1. The value of ^tRAS used for the -13E part is calculated from ^tRC - ^tRP. Actual device specification value is 37ns.

Figure 10: 168-Pin DIMM

FRONT VIEW

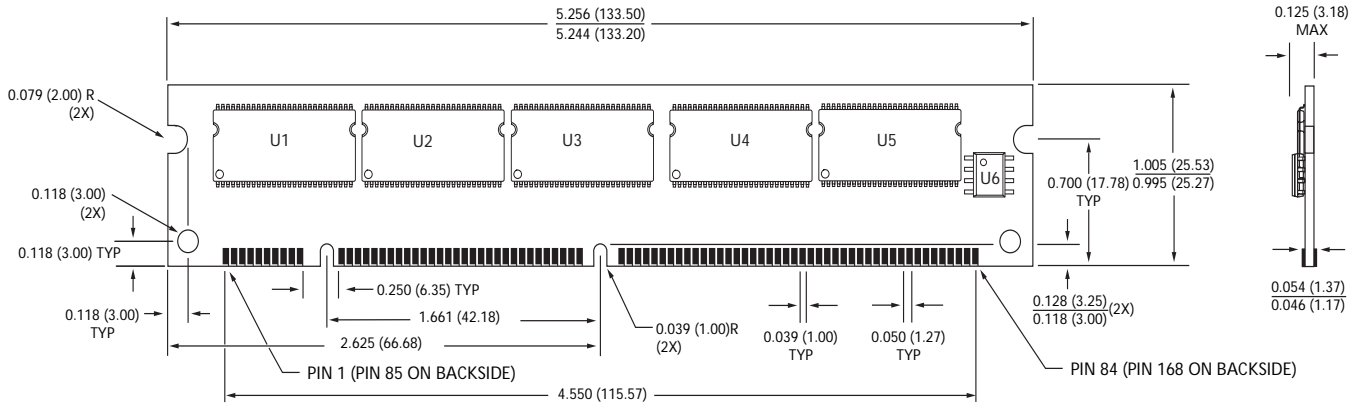

NOTE:

All dimensions in inches (millimeters) $\frac{\text{MAX}}{\text{MIN}}$ or typical where noted.

Data Sheet Designation

Released (No Mark): This data sheet contains minimum and maximum limits specified over the complete power supply and temperature range for production devices.

Although considered final, these specifications are subject to change, as further product development and data characterization sometimes occur.



8000 S. Federal Way, P.O. Box 6, Boise, ID 83707-0006, Tel: 208-368-3900

E-mail: prodmktg@micron.com, Internet: <http://www.micron.com>, Customer Comment Line: 800-932-4992

Micron, the M logo, and the Micron logo are trademarks and/or service marks of Micron Technology, Inc.

All other trademarks are the property of their respective owners.