

Features

- High impedance value
- Current rating up to 400 mA
- RoHS compliant* and halogen free**

Applications

- Noise suppression
- Personal computers
- Display panels

SRF2012A Series - Common Mode Chip Inductors

Electrical Specifications

Part Number	Impedance @ 100 MHz		Rated Voltage (VDC)	Withstanding Voltage (DC)	Insulation Resistance (MΩ) Min.	DCR Max. (Ω)	IDC Max. (mA)
	(Ω)	Tolerance (%)					
SRF2012-670YA	67	±25	50	125	10	0.25	400
SRF2012-900YA	90	±25	50	125	10	0.3	400
SRF2012-121YA	120	±25	50	125	10	0.3	400
SRF2012-161YA	160	±25	50	125	10	0.35	350
SRF2012-181YA	180	±25	50	125	10	0.35	350
SRF2012-201YA	200	±25	50	125	10	0.4	300
SRF2012-221YA	220	±25	50	125	10	0.4	300
SRF2012-261YA	260	±25	50	125	10	0.4	300
SRF2012-361YA	360	±25	50	125	10	0.45	300

General Specifications

Reflow soldering.... 230 °C; 50 sec max.
 Operating Temperature -40 °C to +125 °C
 (Temperature rise included)
 Storage Temperature -40 °C to +125 °C
 Resistance to Soldering Heat 260 °C, 10 sec. max.
 Temperature Rise 30 °C max. at IDC

Materials

Core.....Ferrite
 Wire Enameled copper
 Terminal Ag/Ni/Sn
 Packaging.....2000 pcs. per 7-inch reel

Soldering Profile

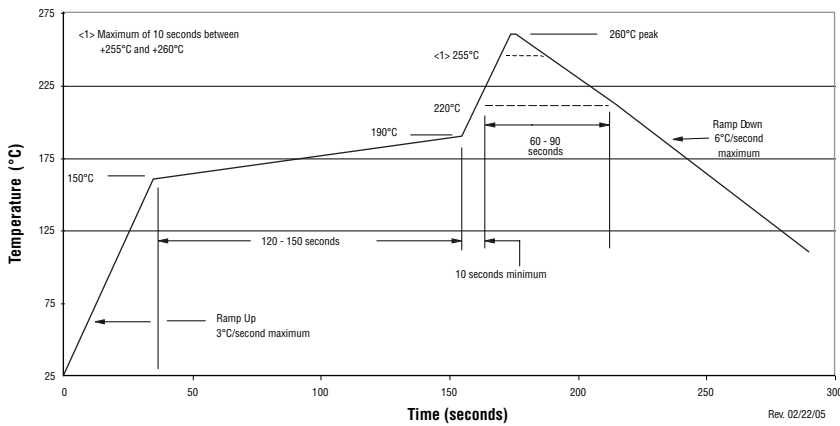

Product Dimensions

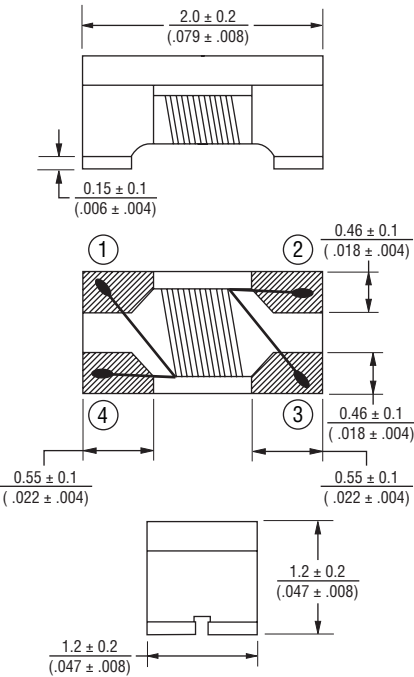

How to Order

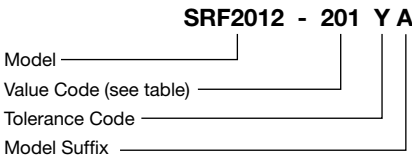

Schematic

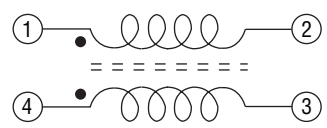

BOURNS®

Asia-Pacific: Tel: +886-2 2562-4117 • Fax: +886-2 2562-4116
 Europe: Tel: +41-41 768 5555 • Fax: +41-41 768 5510
 The Americas: Tel: +1-951 781-5500 • Fax: +1-951 781-5700
www.bourns.com

* RoHS Directive 2002/95/EC Jan 27, 2003 including Annex.
 ** Bourns follows the prevailing definition of "halogen free" in the industry. Bourns considers a product to be "halogen free" if (a) the Bromine (Br) content is 900 ppm or less; (b) the Chlorine (Cl) content is 900 ppm or less; and (c) the total Bromine (Br) and Chlorine (Cl) content is 1500 ppm or less.
 Specifications are subject to change without notice.
 Customers should verify actual device performance in their specific applications.

Recommended Layout

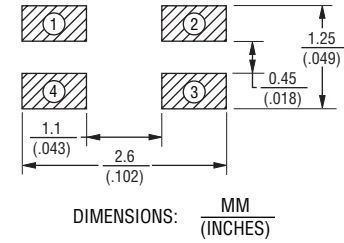

SRF2012A Series - Common Mode Chip Inductors

BOURNS®

Typical Impedance vs. Frequency Curves

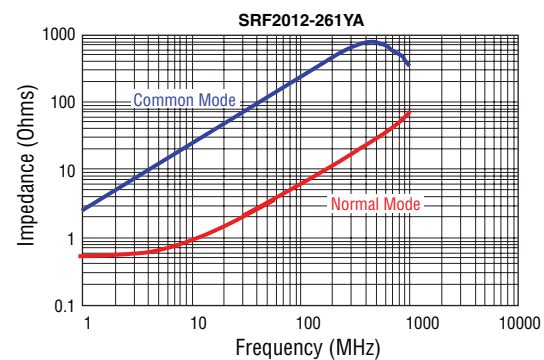
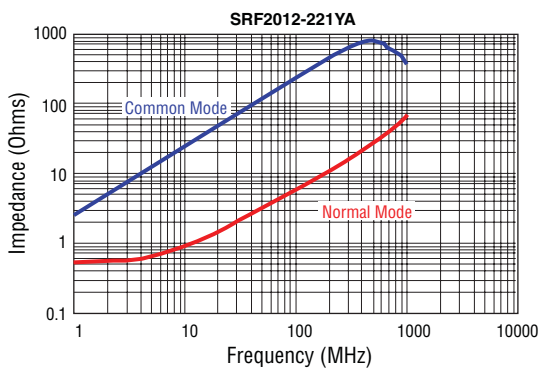
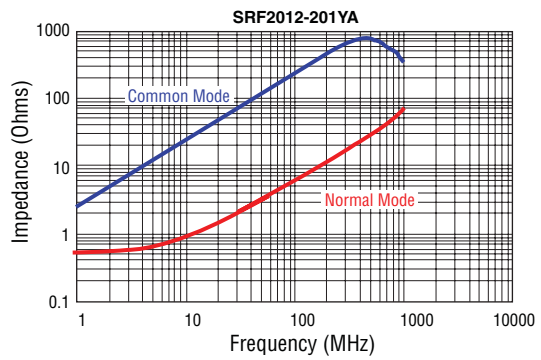
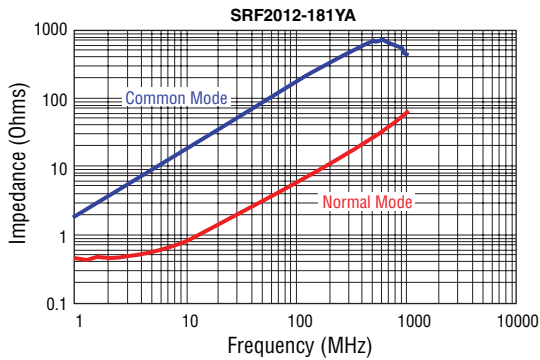
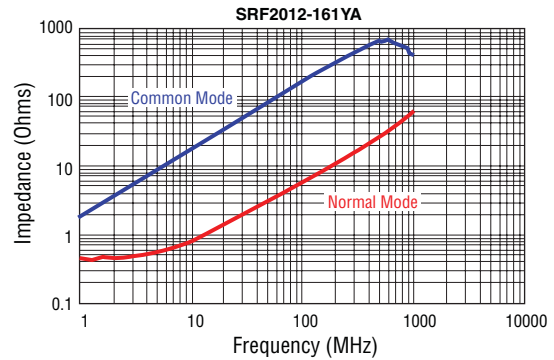
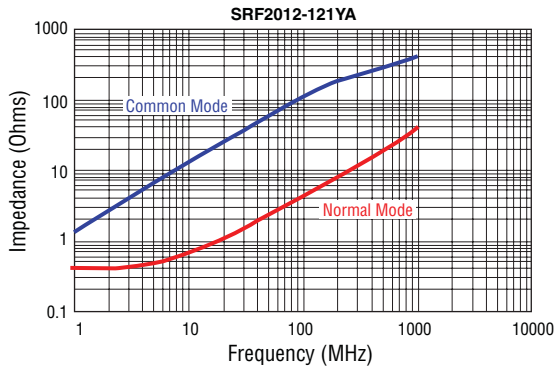
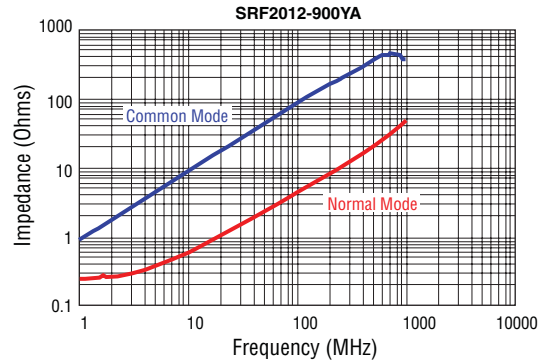
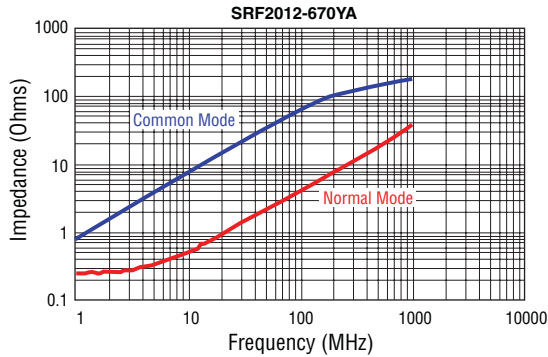

Specifications are subject to change without notice.
Customers should verify actual device performance in their specific applications.

SRF2012A Series - Common Mode Chip Inductors

BOURNS®

Typical Impedance vs. Frequency Curves (Continued)

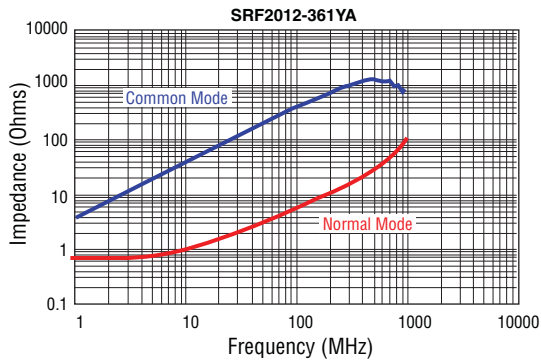

Packaging Specifications

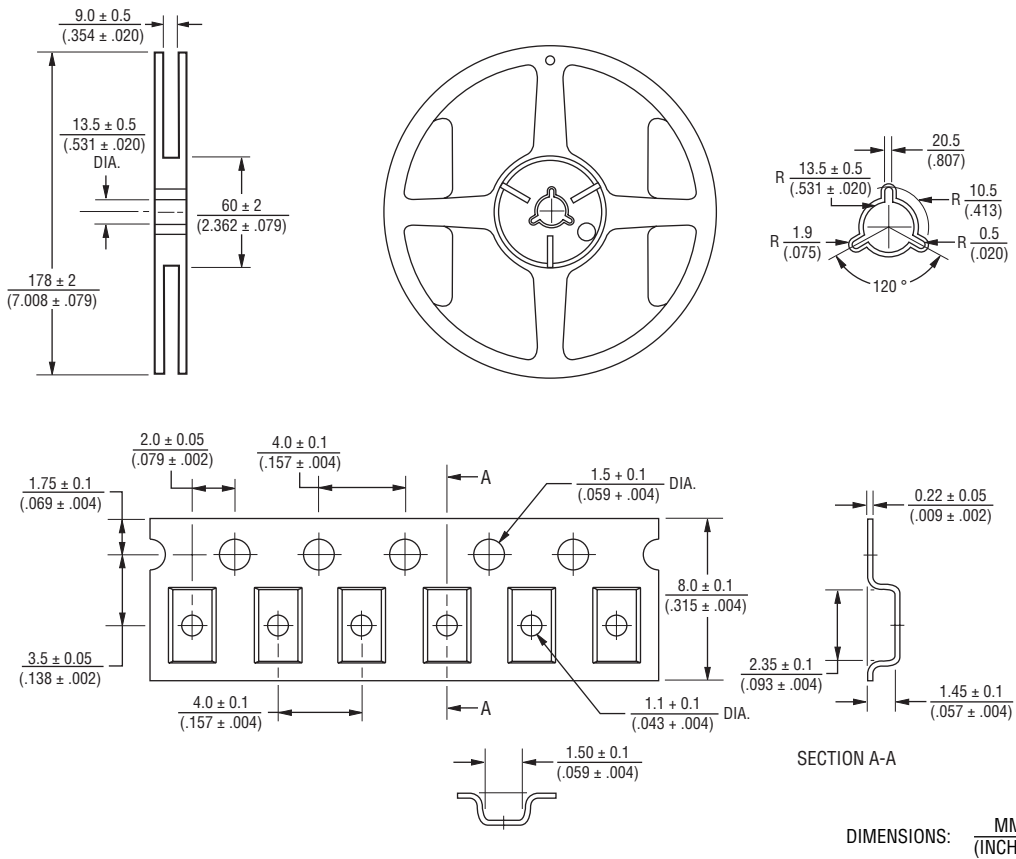

USER DIRECTION OF FEED →
QTY: 2000 PCS. PER REEL

06/11

Specifications are subject to change without notice.
 Customers should verify actual device performance in their specific applications.