

256Mb F-die DDR2 SDRAM Specification
Version 1.5

February 2005

Contents

0. Ordering Information

1. Key Feature

2. Package Pinout/Mechanical Dimension & Addressing

2.1 Package Pinout & Mechanical Dimension

2.2 Input/Output Function Description

2.3 Addressing

3. Absolute Maximum Rating

4. AC & DC Operating Conditions & Specifications

0. Ordering Information

Organization	DDR2-667 5-5-5	DDR2-533 4-4-4	DDR2-400 3-3-3	Package
64Mx4	-	K4T56043QF-GCD5	K4T56043QF-GCCC	Leaded
64Mx4	-	K4T56043QF-ZCD5	K4T56043QF-ZCCC	Lead-free
32Mx8	K4T56083QF-GCE6	K4T56083QF-GCD5	K4T56083QF-GCCC	Leaded
32Mx8	K4T56083QF-ZCE6	K4T56083QF-ZCD5	K4T56083QF-ZCCC	Lead-free

Note: Speed bin is in order of CL-tRCD-tRP

1.Key Features

Speed	DDR2-667 5-5-5	DDR2-533 4-4-4	DDR2-400 3-3-3	Units
CAS Latency	5	4	3	tCK
tRCD(min)	15	15	15	ns
tRP(min)	15	15	15	ns
tRC(min)	54	55	55	ns

- JEDEC standard 1.8V ± 0.1V Power Supply
- VDDQ = 1.8V ± 0.1V
- 200 MHz f_{CK} for 400Mb/sec/pin, 267MHz f_{CK} for 533Mb/sec/pin, 333MHz f_{CK} for 667Mb/sec/pin
- 4 Banks
- Posted CAS
- Programmable CAS Latency: 3, 4, 5
- Programmable Additive Latency: 0, 1, 2, 3 and 4
- Write Latency(WL) = Read Latency(RL) - 1
- Burst Length: 4, 8(Interleave/nibble sequential)
- Programmable Sequential / Interleave Burst Mode
- Bi-directional Differential Data-Strobe (Single-ended data-strobe is an optional feature)
- Off-Chip Driver(OCD) Impedance Adjustment
- On Die Termination
- Average Refresh Period 7.8us at lower than T_{CASE} 85°C, 3.9us at 85°C < T_{CASE} ≤ 95 °C
- Package: 60ball FBGA - 64Mx4/32Mx8
- All of Lead-free products are compliant for RoHS

The 256Mb DDR2 SDRAM chip is organized as either 16Mbit x 4 I/Os x 4 banks or 8Mbit x 8 I/Os x 4banks device. This synchronous device achieves high speed double-data-rate transfer rates of up to 667Mb/sec/pin (DDR2-667) for general applications.

The chip is designed to comply with the following key DDR2 SDRAM features such as posted CAS with additive latency, write latency = read latency - 1, Off-Chip Driver(OCD) impedance adjustment and On Die Termination.

All of the control and address inputs are synchronized with a pair of externally supplied differential clocks. Inputs are latched at the crosspoint of differential clocks (CK rising and CK falling). All I/Os are synchronized with a pair of bidirectional strobes (DQS and DQS) in a source synchronous fashion. The address bus is used to convey row, column, and bank address information in a RAS/CAS multiplexing style. For example, 256Mb(x4) device receive 13/11/2 addressing.

The 256Mb DDR2 device operates with a single 1.8V ± 0.1V power supply and 1.8V ± 0.1V VDDQ.

The 256Mb DDR2 device is available in 60ball FBGAs(x4/x8).

Note: The functionality described and the timing specifications included in this data sheet are for the DLL Enabled mode of operation.

Note : This data sheet is an abstract of full DDR2 specification and does not cover the common features which are described in "Samsung's DDR2 SDRAM Device Operation & Timing Diagram"



2. Package Pinout/Mechanical Dimension & Addressing

2.1 Package Pinout

x4 package pinout (Top View) : 60ball FBGA Package

1	2	3		7	8	9
VDD	NC	VSS	A	VSSQ	DQS	VDDQ
NC	VSSQ	DM	B	DQS	VSSQ	NC
VDDQ	DQ1	VDDQ	C	VDDQ	DQ0	VDDQ
NC	VSSQ	DQ3	D	DQ2	VSSQ	NC
VDDL	VREF	VSS	E	VSSDL	CK	VDD
	CKE	WE	F	RAS	CK	ODT
NC	BA0	BA1	G	CAS	CS	
	A10	A1	H	A2	A0	VDD
VSS	A3	A5	J	A6	A4	
	A7	A9	K	A11	A8	VSS
VDD	A12	NC	L	NC	NC	

Notes:

1. Pin B3 has identical capacitance as pin B7.
2. VDDL and VSSDL are power and ground for the DLL.

Ball Locations (x4)

- : Populated Ball
- + : Depopulated Ball

Top View (See the balls through the Package)

	1	2	3	4	5	6	7	8	9
A	●	●	●	+	+	+	●	●	●
B	●	●	●	+	+	+	●	●	●
C	●	●	●	+	+	+	●	●	●
D	●	●	●	+	+	+	●	●	●
E	●	●	●	+	+	+	●	●	●
F	+	●	●	+	+	+	●	●	●
G	●	●	●	+	+	+	●	●	+
H	+	●	●	+	+	+	●	●	●
J	●	●	●	+	+	+	●	●	+
K	+	●	●	+	+	+	●	●	●
L	●	●	●	+	+	+	●	●	+

x8 package pinout (Top View) : 60ball FBGA Package

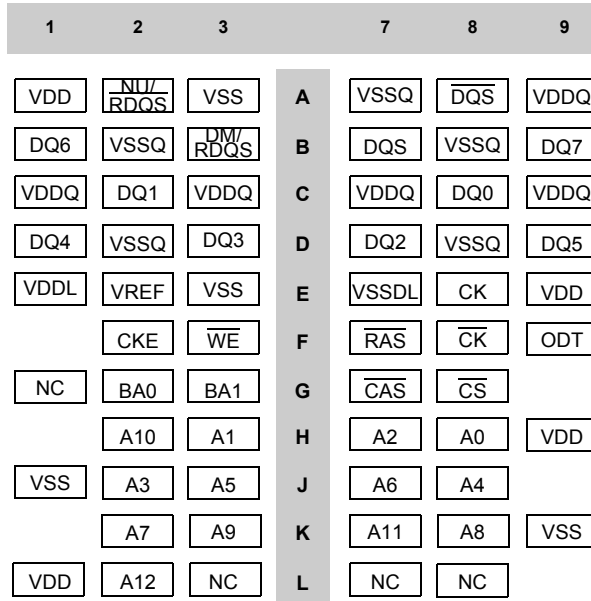

Notes:

1. Pins B3 and A2 have identical capacitance as pins B7 and A8.
2. For a read, when enabled, strobe pair RDQS & RDQS are identical in function and timing to strobe pair DQS & DQS and input masking function is disabled.
3. The function of DM or RDQS/RDQS are enabled by EMRS command.
4. VDDL and VSSDL are power and ground for the DLL.

Ball Locations (x8)

- : Populated Ball
- + : Depopulated Ball

Top View (See the balls through the Package)

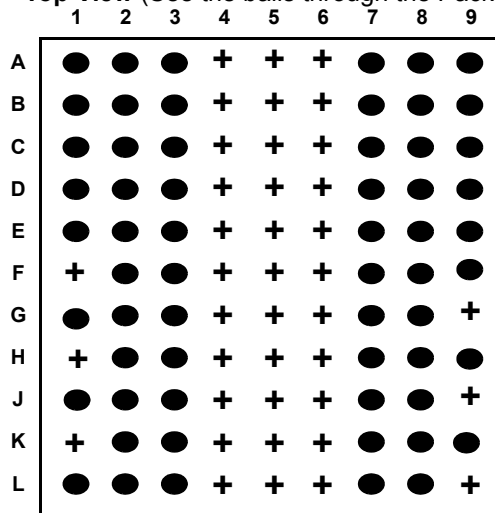

FBGA Package Dimension(x4/x8)

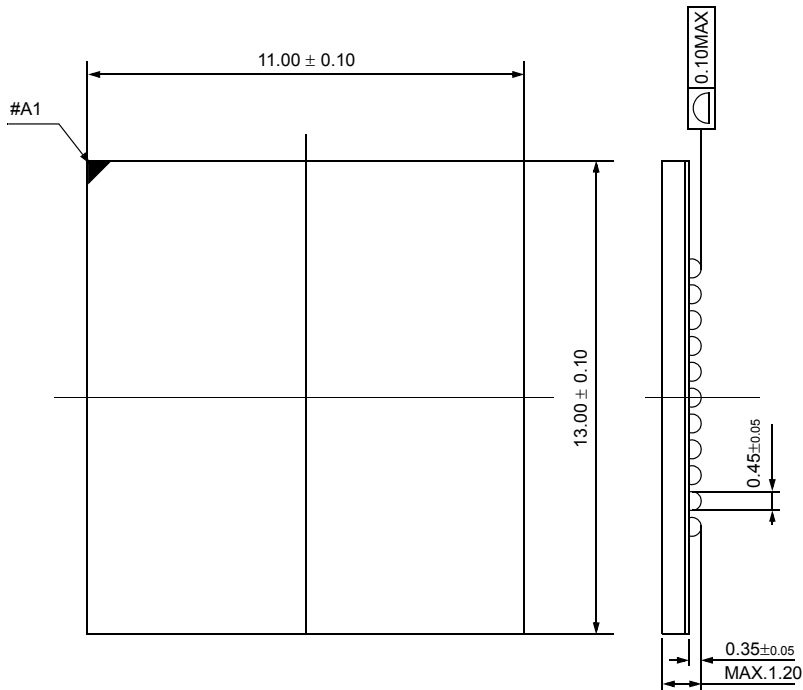
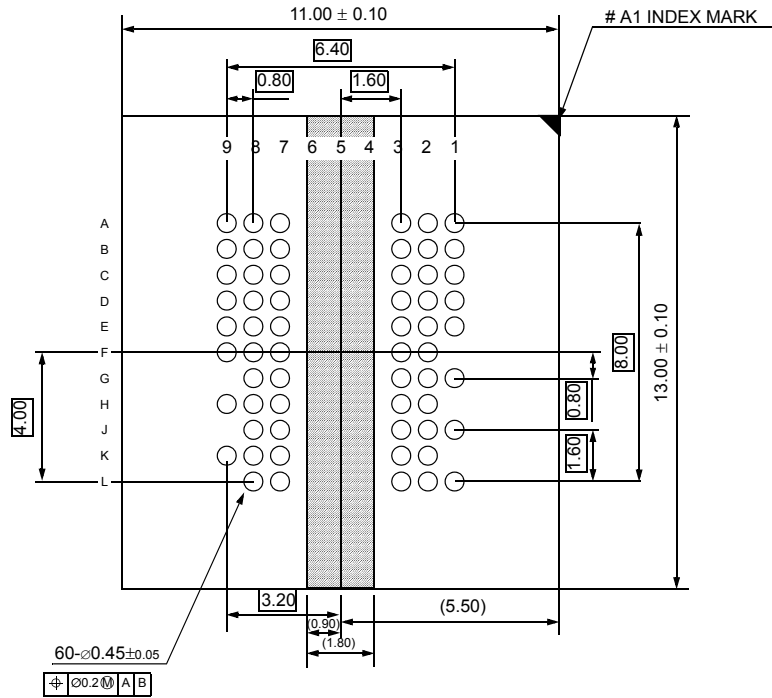

2.2 Input/Output Functional Description

Symbol	Type	Function
CK, $\overline{\text{CK}}$	Input	Clock: CK and $\overline{\text{CK}}$ are differential clock inputs. All address and control input signals are sampled on the crossing of the positive edge of CK and negative edge of $\overline{\text{CK}}$. Output (read) data is referenced to the crossings of CK and $\overline{\text{CK}}$ (both directions of crossing).
CKE	Input	Clock Enable: CKE HIGH activates, and CKE Low deactivates, internal clock signals and device input buffers and output drivers. Taking CKE Low provides Precharge Power-Down and Self Refresh operation (all banks idle), or Active Power-Down (row Active in any bank). CKE is synchronous for power down entry and exit, and for self refresh entry. CKE is asynchronous for self refresh exit. After V_{REF} has become stable during the power on and initialization sequence, it must be maintained for proper operation of the CKE receiver. For proper self-refresh entry and exit, V_{REF} must be maintained to this input. $\overline{\text{CKE}}$ must be maintained high throughout read and write accesses. Input buffers, excluding CK, $\overline{\text{CK}}$, ODT and CKE are disabled during power-down. Input buffers, excluding CKE, are disabled during self refresh.
$\overline{\text{CS}}$	Input	Chip Select: All commands are masked when $\overline{\text{CS}}$ is registered HIGH. $\overline{\text{CS}}$ provides for external Rank selection on systems with multiple Ranks. $\overline{\text{CS}}$ is considered part of the command code.
ODT	Input	On Die Termination: ODT (registered HIGH) enables termination resistance internal to the DDR2 SDRAM. When enabled, ODT is only applied to each DQ, DQS, $\overline{\text{DQS}}$, RDQS, $\overline{\text{RDQS}}$, and DM signal for x4/x8 configurations. The ODT pin will be ignored if the Extended Mode Register Set(EMRS) is programmed to disable ODT.
$\overline{\text{RAS}}$, $\overline{\text{CAS}}$, $\overline{\text{WE}}$	Input	Command Inputs: $\overline{\text{RAS}}$, $\overline{\text{CAS}}$ and $\overline{\text{WE}}$ (along with $\overline{\text{CS}}$) define the command being entered.
DM	Input	Input Data Mask: DM is an input mask signal for write data. Input data is masked when DM is sampled HIGH coincident with that input data during a Write access. DM is sampled on both edges of DQS. Although DM pins are input only, the DM loading matches the DQ and DQS loading. For x8 device, the function of DM or RDQS/RDQS is enabled by EMRS command.
BA0 - BA1	Input	Bank Address Inputs: BA0 and BA1 define to which bank an Active, Read, Write or Precharge command is being applied. Bank address also determines if the mode register or extended mode register is to be accessed during a MRS or EMRS cycle.
A0 - A12	Input	Address Inputs: Provided the row address for Active commands and the column address and Auto Precharge bit for Read/Write commands to select one location out of the memory array in the respective bank. A10 is sampled during a Precharge command to determine whether the Precharge applies to one bank (A10 LOW) or all banks (A10 HIGH). If only one bank is to be precharged, the bank is selected by BA0, BA1. The address inputs also provide the op-code during Mode Register Set commands.
DQ	Input/Output	Data Input/ Output: Bi-directional data bus.
DQS, $\overline{\text{DQS}}$ (RDQS), $\overline{\text{RDQS}}$	Input/Output	Data Strobe: output with read data, input with write data. Edge-aligned with read data, centered in write data. For the x8, an RDQS option using DM pin can be enabled via the EMRS(1) to simplify read timing. The data strobes DQS and RDQS may be used in single ended mode or paired with optional complementary signals $\overline{\text{DQS}}$ and $\overline{\text{RDQS}}$ to provide differential pair signaling to the system during both reads and writes. An EMRS(1) control bit enables or disables all complementary data strobe signals.
NC		No Connect: No internal electrical connection is present.
V_{DD} / V_{DDQ}	Supply	Power Supply: 1.8V +/- 0.1V, DQ Power Supply: 1.8V +/- 0.1V
V_{SS} / V_{SSQ}	Supply	Ground, DQ Ground
V_{DDL}	Supply	DLL Power Supply: 1.8V +/- 0.1V
V_{SSDL}	Supply	DLL Ground
V_{REF}	Supply	Reference voltage

In this data sheet, "differential DQS signals" refers to any of the following with A10 = 0 of EMRS(1)
 x4 DQS/DQS
 x8 DQS/DQS _____ if EMRS(1)[A11] = 0
 x8 DQS/DQS, RDQS/RDQS, _____ if EMRS(1)[A11] = 1

"single-ended DQS signals" refers to any of the following with A10 = 1 of EMRS(1)
 x4 DQS
 x8 DQS if EMRS(1) [A11] = 0
 x8 DQS, RDQS, if EMRS(1) [A11] = 1



2.3 256Mb Addressing

Configuration	64Mb x4	32Mb x 8
# of Bank	4	4
Bank Address	BA0,BA1	BA0,BA1
Auto precharge	A ₁₀ /AP	A ₁₀ /AP
Row Address	A ₀ ~ A ₁₂	A ₀ ~ A ₁₂
Column Address	A ₀ ~ A ₉ ,A ₁₁	A ₀ ~ A ₉

* Reference information: The following tables are address mapping information for other densities.

512Mb

Configuration	128Mb x4	64Mb x 8	32Mb x16
# of Bank	4	4	4
Bank Address	BA0,BA1	BA0,BA1	BA0,BA1
Auto precharge	A ₁₀ /AP	A ₁₀ /AP	A ₁₀ /AP
Row Address	A ₀ ~ A ₁₃	A ₀ ~ A ₁₃	A ₀ ~ A ₁₂
Column Address	A ₀ ~ A ₉ ,A ₁₁	A ₀ ~ A ₉	A ₀ ~ A ₉

1Gb

Configuration	256Mb x4	128Mb x 8	64Mb x16
# of Bank	8	8	8
Bank Address	BA0 ~ BA2	BA0 ~ BA2	BA0 ~ BA2
Auto precharge	A ₁₀ /AP	A ₁₀ /AP	A ₁₀ /AP
Row Address	A ₀ ~ A ₁₃	A ₀ ~ A ₁₃	A ₀ ~ A ₁₂
Column Address	A ₀ ~ A ₉ ,A ₁₁	A ₀ ~ A ₉	A ₀ ~ A ₉

2Gb

Configuration	512Mb x4	256Mb x 8	128Mb x16
# of Bank	8	8	8
Bank Address	BA0 ~ BA2	BA0 ~ BA2	BA0 ~ BA2
Auto precharge	A ₁₀ /AP	A ₁₀ /AP	A ₁₀ /AP
Row Address	A ₀ ~ A ₁₄	A ₀ ~ A ₁₄	A ₀ ~ A ₁₃
Column Address	A ₀ ~ A ₉ ,A ₁₁	A ₀ ~ A ₉	A ₀ ~ A ₉

4Gb

Configuration	1 Gb x4	512Mb x 8	256Mb x16
# of Bank	8	8	8
Bank Address	BA0 ~ BA2	BA0 ~ BA2	BA0 ~ BA2
Auto precharge	A ₁₀ /AP	A ₁₀ /AP	A ₁₀ /AP
Row Address	A ₀ ~ A ₁₅	A ₀ ~ A ₁₅	A ₀ ~ A ₁₄
Column Address/page size	A ₀ ~ A ₉ ,A ₁₁	A ₀ ~ A ₉	A ₀ ~ A ₉

3. Absolute Maximum DC Ratings

Symbol	Parameter	Rating	Units	Notes
VDD	Voltage on VDD pin relative to Vss	- 1.0 V ~ 2.3 V	V	1
VDDQ	Voltage on VDDQ pin relative to Vss	- 0.5 V ~ 2.3 V	V	1
VDDL	Voltage on VDDL pin relative to Vss	- 0.5 V ~ 2.3 V	V	1
V _{IN} , V _{OUT}	Voltage on any pin relative to Vss	- 0.5 V ~ 2.3 V	V	1
T _{STG}	Storage Temperature	-55 to +100	°C	1, 2

1. Stresses greater than those listed under "Absolute Maximum Ratings" may cause permanent damage to the device. This is a stress rating only and functional operation of the device at these or any other conditions above those indicated in the operational sections of this specification is not implied. Exposure to absolute maximum rating conditions for extended periods may affect reliability.
2. Storage Temperature is the case surface temperature on the center/top side of the DRAM. For the measurement conditions, please refer to JESD51-2 standard.

4. AC & DC Operating Conditions
Recommended DC Operating Conditions (SSTL - 1.8)

Symbol	Parameter	Rating			Units	Notes
		Min.	Typ.	Max.		
VDD	Supply Voltage	1.7	1.8	1.9	V	
VDDL	Supply Voltage for DLL	1.7	1.8	1.9	V	4
VDDQ	Supply Voltage for Output	1.7	1.8	1.9	V	4
VREF	Input Reference Voltage	0.49*VDDQ	0.50*VDDQ	0.51*VDDQ	mV	1,2
VTT	Termination Voltage	VREF-0.04	VREF	VREF+0.04	V	3

- There is no specific device VDD supply voltage requirement for SSTL-1.8 compliance. However under all conditions VDDQ must be less than or equal to VDD.
1. The value of VREF may be selected by the user to provide optimum noise margin in the system. Typically the value of VREF is expected to be about 0.5 x VDDQ of the transmitting device and VREF is expected to track variations in VDDQ.
 2. Peak to peak AC noise on VREF may not exceed +/-2% VREF(DC).
 3. VTT of transmitting device must track VREF of receiving device.
 4. AC parameters are measured with VDD, VDDQ and VDDL tied together.

Operating Temperature Condition

Symbol	Parameter	Rating	Units	Notes
TOPER	Operating Temperature	0 to 95	°C	1, 2

1. Operating Temperature is the case surface temperature on the center/top side of the DRAM. For the measurement conditions, please refer to JESD51.2 standard.
2. At 85 - 95 °C operation temperature range, doubling refresh commands in frequency to a 32ms period (tREFI=3.9 us) is required, and to enter to self refresh mode at this temperature range, an EMRS command is required to change internal refresh rate.

Input DC Logic Level

Symbol	Parameter	Min.	Max.	Units	Notes
V _{IH} (DC)	DC input logic high	VREF + 0.125	VDDQ + 0.3	V	
V _{IL} (DC)	DC input logic low	- 0.3	VREF - 0.125	V	

Input AC Logic Level

Symbol	Parameter	DDR2-400, DDR2-533		DDR2-667	
		Min.	Max.	Min.	Max.
V _{IH} (ac)	ac input logic high	VREF + 0.250	-	VREF + 0.200	
V _{IL} (ac)	ac input logic low	-	VREF - 0.250		VREF - 0.200

AC Input Test Conditions

Symbol	Condition	Value	Units	Notes
V _{REF}	Input reference voltage	0.5 * V _{DDQ}	V	1
V _{SWING(MAX)}	Input signal maximum peak to peak swing	1.0	V	1
SLEW	Input signal minimum slew rate	1.0	V/ns	2, 3

Notes:

1. Input waveform timing is referenced to the input signal crossing through the V_{IH/IL}(AC) level applied to the device under test.
2. The input signal minimum slew rate is to be maintained over the range from V_{REF} to V_{IH}(AC) min for rising edges and the range from V_{REF} to V_{IL}(AC) max for falling edges as shown in the below figure.
3. AC timings are referenced with input waveforms switching from V_{IL}(AC) to V_{IH}(AC) on the positive transitions and V_{IH}(AC) to V_{IL}(AC) on the negative transitions.

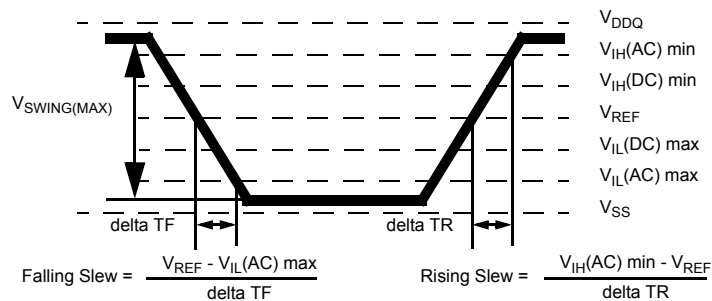

< AC Input Test Signal Waveform >

Differential input AC logic Level

Symbol	Parameter	Min.	Max.	Units	Notes
V _{ID} (AC)	AC differential input voltage	0.5	V _{DDQ} + 0.6	V	1
V _{IX} (AC)	AC differential cross point voltage	0.5 * V _{DDQ} - 0.175	0.5 * V _{DDQ} + 0.175	V	2

Notes:

1. V_{ID}(AC) specifies the input differential voltage |V_{TR} - V_{CP}| required for switching, where V_{TR} is the true input signal (such as CK, DQS, LDQS or UDQS) and V_{CP} is the complementary input signal (such as $\bar{C}K$, $\bar{D}QS$, $\bar{L}DQS$ or $\bar{U}DQS$). The minimum value is equal to V_{IH}(AC) - V_{IL}(AC).
2. The typical value of V_{IX}(AC) is expected to be about 0.5 * V_{DDQ} of the transmitting device and V_{IX}(AC) is expected to track variations in V_{DDQ}. V_{IX}(AC) indicates the voltage at which differential input signals must cross.

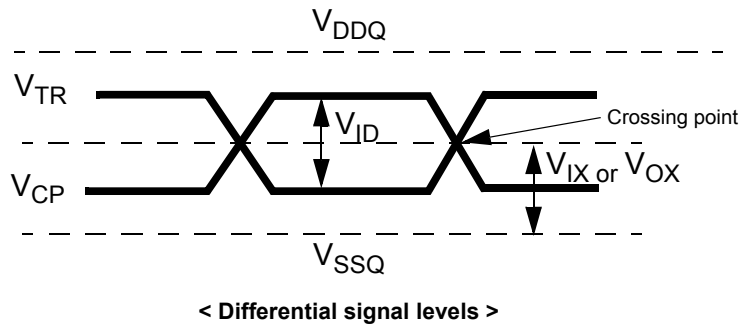

Differential AC output parameters

Symbol	Parameter	Min.	Max.	Units	Note
V _{OX} (AC)	AC differential cross point voltage	0.5 * V _{DDQ} - 0.125	0.5 * V _{DDQ} + 0.125	V	1

Note :

1. The typical value of V_{OX}(AC) is expected to be about 0.5 * V_{DDQ} of the transmitting device and V_{OX}(AC) is expected to track variations in V_{DDQ}. V_{OX}(AC) indicates the voltage at which differential output signals must cross.

OCD default characteristics

Description	Parameter	Min	Nom	Max	Unit	Notes
Output impedance		12.6	18	23.4	ohms	1,2
Output impedance step size for OCD calibration		0		1.5	ohms	6
Pull-up and pull-down mismatch		0		4	ohms	1,2,3
Output slew rate	Sout	1.5		5	V/ns	1,4,5,6,7,8

Notes:

1. Absolute Specifications ($0^{\circ}\text{C} \leq T_{\text{CASE}} \leq +95^{\circ}\text{C}$; $V_{\text{DD}} = +1.8\text{V} \pm 0.1\text{V}$, $V_{\text{DDQ}} = +1.8\text{V} \pm 0.1\text{V}$)
2. Impedance measurement condition for output source dc current: $V_{\text{DDQ}} = 1.7\text{V}$; $V_{\text{OUT}} = 1420\text{mV}$; $(V_{\text{OUT}} - V_{\text{DDQ}}) / I_{\text{oh}}$ must be less than 23.4 ohms for values of V_{OUT} between V_{DDQ} and $V_{\text{DDQ}} - 280\text{mV}$. Impedance measurement condition for output sink dc current: $V_{\text{DDQ}} = 1.7\text{V}$; $V_{\text{OUT}} = 280\text{mV}$; $V_{\text{OUT}} / I_{\text{ol}}$ must be less than 23.4 ohms for values of V_{OUT} between 0V and 280mV .
3. Mismatch is absolute value between pull-up and pull-dn, both are measured at same temperature and voltage.
4. Slew rate measured from $V_{\text{IL}}(\text{AC})$ to $V_{\text{IH}}(\text{AC})$.
5. The absolute value of the slew rate as measured from DC to DC is equal to or greater than the slew rate as measured from AC to AC. This is guaranteed by design and characterization.
6. This represents the step size when the OCD is near 18 ohms at nominal conditions across all process and represents only the DRAM uncertainty.

Output slew rate load :

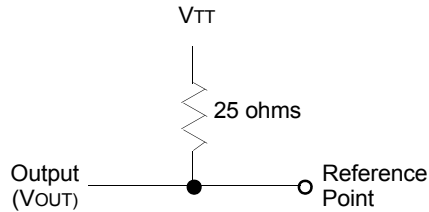

7. DRAM output slew rate specification applies to 400Mb/sec/pin, 533Mb/sec/pin and 667Mb/sec/pin speed bins.
8. Timing skew due to DRAM output slew rate mis-match between $\overline{\text{DQS}} / \overline{\text{DQS}}$ and associated DQs is included in t_{DQSQ} and t_{QHS} specification.

IDD Specification Parameters and Test Conditions

(IDD values are for full operating range of Voltage and Temperature, Notes 1 - 5)

Symbol	Proposed Conditions	Units	Notes
IDD0	Operating one bank active-precharge current; $t_{CK} = t_{CK}(IDD)$, $t_{RC} = t_{RC}(IDD)$, $t_{RAS} = t_{RASmin}(IDD)$; CKE is HIGH, CS\ is HIGH between valid commands; Address bus inputs are SWITCHING; Data bus inputs are SWITCHING	mA	
IDD1	Operating one bank active-read-precharge current; IOUT = 0mA; BL = 4, CL = CL(IDD), AL = 0; $t_{CK} = t_{CK}(IDD)$, $t_{RC} = t_{RC}(IDD)$, $t_{RAS} = t_{RASmin}(IDD)$, $t_{RCD} = t_{RCD}(IDD)$; CKE is HIGH, CS\ is HIGH between valid commands; Address bus inputs are SWITCHING; Data pattern is same as IDD4W	mA	
IDD2P	Precharge power-down current; All banks idle; $t_{CK} = t_{CK}(IDD)$; CKE is LOW; Other control and address bus inputs are STABLE; Data bus inputs are FLOATING	mA	
IDD2Q	Precharge quiet standby current; All banks idle; $t_{CK} = t_{CK}(IDD)$; CKE is HIGH, CS\ is HIGH; Other control and address bus inputs are STABLE; Data bus inputs are FLOATING	mA	
IDD2N	Precharge standby current; All banks idle; $t_{CK} = t_{CK}(IDD)$; CKE is HIGH, CS\ is HIGH; Other control and address bus inputs are SWITCHING; Data bus inputs are SWITCHING	mA	
IDD3P	Active power-down current; All banks open; $t_{CK} = t_{CK}(IDD)$; CKE is LOW; Other control and address bus inputs are STABLE; Data bus inputs are FLOATING	Fast PDN Exit MRS(12) = 0mA	mA
		Slow PDN Exit MRS(12) = 1mA	mA
IDD3N	Active standby current; All banks open; $t_{CK} = t_{CK}(IDD)$, $t_{RAS} = t_{RASmax}(IDD)$, $t_{RP} = t_{RP}(IDD)$; CKE is HIGH, CS\ is HIGH between valid commands; Other control and address bus inputs are SWITCHING; Data bus inputs are SWITCHING	mA	
IDD4W	Operating burst write current; All banks open, Continuous burst writes; BL = 4, CL = CL(IDD), AL = 0; $t_{CK} = t_{CK}(IDD)$, $t_{RAS} = t_{RASmax}(IDD)$, $t_{RP} = t_{RP}(IDD)$; CKE is HIGH, CS\ is HIGH between valid commands; Address bus inputs are SWITCHING; Data bus inputs are SWITCHING	mA	
IDD4R	Operating burst read current; All banks open, Continuous burst reads, IOUT = 0mA; BL = 4, CL = CL(IDD), AL = 0; $t_{CK} = t_{CK}(IDD)$, $t_{RAS} = t_{RASmax}(IDD)$, $t_{RP} = t_{RP}(IDD)$; CKE is HIGH, CS\ is HIGH between valid commands; Address bus inputs are SWITCHING; Data pattern is same as IDD4W	mA	
IDD5B	Burst auto refresh current; $t_{CK} = t_{CK}(IDD)$; Refresh command at every $t_{RFC}(IDD)$ interval; CKE is HIGH, CS\ is HIGH between valid commands; Other control and address bus inputs are SWITCHING; Data bus inputs are SWITCHING	mA	
IDD6	Self refresh current; CK and CK\ at 0V; $CKE \leq 0.2V$; Other control and address bus inputs are FLOATING; Data bus inputs are FLOATING	Normal	mA
		Low Power	mA
IDD7	Operating bank interleave read current; All bank interleaving reads, IOUT = 0mA; BL = 4, CL = CL(IDD), AL = $t_{RCD}(IDD) - 1 * t_{CK}(IDD)$; $t_{CK} = t_{CK}(IDD)$, $t_{RC} = t_{RC}(IDD)$, $t_{RRD} = t_{RRD}(IDD)$, $t_{RCD} = 1 * t_{CK}(IDD)$; CKE is HIGH, CS\ is HIGH between valid commands; Address bus inputs are STABLE during DESELECTs; Data pattern is same as IDD4R; Refer to the following page for detailed timing conditions	mA	

Notes:

1. IDD specifications are tested after the device is properly initialized
2. Input slew rate is specified by AC Parametric Test Condition
3. IDD parameters are specified with ODT disabled.
4. Data bus consists of DQ, DM, DQS, DQS\, RDQS, RDQS\, LDQS, LDQS\, UDQS, and UDQS\. IDD values must be met with all combinations of EMRS bits 10 and 11.
5. Definitions for IDD
 - LOW is defined as $V_{in} \leq V_{ILAC(max)}$
 - HIGH is defined as $V_{in} \geq V_{IHAC(min)}$
 - STABLE is defined as inputs stable at a HIGH or LOW level
 - FLOATING is defined as inputs at $V_{REF} = V_{DDQ}/2$
 - SWITCHING is defined as:
 - inputs changing between HIGH and LOW every other clock cycle (once per two clocks) for address and control signals, and
 - inputs changing between HIGH and LOW every other data transfer (once per clock) for DQ signals not including masks or strobes.

For purposes of IDD testing, the following parameters are utilized

	DDR2-667	DDR2-533	DDR2-400	
Parameter	5-5-5	4-4-4	3-3-3	Units
CL(IDD)	5	4	3	tCK
t _{RC} (IDD)	15	15	15	ns
t _{RC} (IDD)	60	60	55	ns
t _{RRD} (IDD)-x4/x8	7.5	7.5	7.5	ns
t _{RRD} (IDD)-x16	10	10	10	ns
t _{CK} (IDD)	3	3.75	5	ns
t _{RASmin} (IDD)	45	45	40	ns
t _{RP} (IDD)	15	15	15	ns
t _{RFC} (IDD)	105	105	105	ns

Detailed IDD7

The detailed timings are shown below for IDD7.
 Legend: A = Active; RA = Read with Autoprecharge; D = Deselect

IDD7: Operating Current: All Bank Interleave Read operation

All banks are being interleaved at minimum t_{RC}(IDD) without violating t_{RRD}(IDD) using a burst length of 4. Control and address bus inputs are STABLE during DESELECTs. IO_{UT} = 0mA

Timing Patterns for 4 bank devices x4/ x8/ x16

- DDR2-400 3/3/3
A0 RA0 A1 RA1 A2 RA2 A3 RA3 D D D
- DDR2-533 4/4/4
A0 RA0 D A1 RA1 D A2 RA2 D A3 RA3 D D D D D
- DDR2-667 5/5/5
A0 RA0 D D A1 RA1 D D A2 RA2 D D A3 RA3 D D D D D D



DDR2 SDRAM IDD Spec Table

Symbol	64Mx4(K4T56043QF)			Unit	Notes
	-	D5(DDR2-533@CL=4)	CC(DDR2-400@CL=3)		
IDD0	-	100	95	mA	
IDD1	-	110	100	mA	
IDD2P	-	8	8	mA	
IDD2Q	-	25	25	mA	
IDD2N	-	30	30	mA	
IDD3P-F	-	30	30	mA	
IDD3P-S	-	15	15	mA	
IDD3N	-	70	65	mA	
IDD4W	-	160	125	mA	
IDD4R	-	150	125	mA	
IDD5B	-	165	160	mA	
IDD6	Normal	-	5	mA	
IDD7	-	250	245	mA	

Symbol	32Mx8(K4T56083QF)			Unit	Notes
	E6(DDR2-667@CL=5)	D5(DDR2-533@CL=4)	CC(DDR2-400@CL=3)		
IDD0	105	100	95	mA	
IDD1	115	110	100	mA	
IDD2P	8	8	8	mA	
IDD2Q	30	25	25	mA	
IDD2N	35	30	30	mA	
IDD3P-F	35	30	30	mA	
IDD3P-S	15	15	15	mA	
IDD3N	75	70	65	mA	
IDD4W	210	175	135	mA	
IDD4R	185	160	130	mA	
IDD5B	170	165	160	mA	
IDD6	Normal	5	5	mA	
IDD7	265	255	255	mA	

Input/Output capacitance

Parameter	Symbol	DDR2-400 DDR2-533		DDR2-667		Units
		Min	Max	Min	Max	
Input capacitance, CK and \overline{CK}	CCK	1.0	2.0	1.0	2.0	pF
Input capacitance delta, CK and \overline{CK}	CDCK	x	0.25	x	0.25	pF
Input capacitance, all other input-only pins	CI	1.0	2.0	1.0	2.0	pF
Input capacitance delta, all other input-only pins	CDI	x	0.25	x	0.25	pF
Input/output capacitance, DQ, DM, DQS, \overline{DQS}	CIO	2.5	4.0	2.5	3.5	pF
Input/output capacitance delta, DQ, DM, DQS, \overline{DQS}	CDIO	x	0.5	x	0.5	pF

Electrical Characteristics & AC Timing for DDR2-667/533/400

(0 °C ≤ T_{CASE} ≤ 95 °C; V_{DDQ} = 1.8V ± 0.1V; V_{DD} = 1.8V ± 0.1V)

Refresh Parameters by Device Density

Parameter	Symbol	256Mb	512Mb	1Gb	2Gb	4Gb	Units	
Refresh to active/Refresh command time	tRFC	75	105	127.5	195	327.5	ns	
Average periodic refresh interval	tREFI	0 °C ≤ T _{CASE} ≤ 85 °C	7.8	7.8	7.8	7.8	7.8	μs
		85 °C < T _{CASE} ≤ 95 °C	3.9	3.9	3.9	3.9	3.9	μs

Speed Bins and CL, tRCD, tRP, tRC and tRAS for Corresponding Bin

Speed	DDR2-667(E6)		DDR2-533(D5)		DDR2-400(CC)		Units
Bin (CL - tRCD - tRP)	5 - 5 - 5		4 - 4 - 4		3 - 3 - 3		
Parameter	min	max	min	max	min	max	
tCK, CL=3	5	8	5	8	5	8	ns
tCK, CL=4	3.75	8	3.75	8	5	8	ns
tCK, CL=5	3	8	-	-	-	-	ns
tRCD	15		15		15		ns
tRP	15		15		15		ns
tRC	54		55		55		ns
tRAS	39	70000	40	70000	40	70000	ns

Timing Parameters by Speed Grade

(Refer to notes for informations related to this table at the bottom)

Parameter	Symbol	DDR2-667		DDR2-533		DDR2-400		Units	Notes
		min	max	min	max	min	max		
DQ output access time from CK/CK	tAC	-450	+450	-500	+500	-600	+600	ps	
DQS output access time from CK/CK	tDQSK	-400	+400	-450	+450	-500	+500	ps	
CK high-level width	tCH	0.45	0.55	0.45	0.55	0.45	0.55	tCK	
CK low-level width	tCL	0.45	0.55	0.45	0.55	0.45	0.55	tCK	
CK half period	tHP	min(tCL, tCH)	x	min(tCL, tCH)	x	min(tCL, tCH)	x	ps	20,21
Clock cycle time, CL=x	tCK	3000	8000	3750	8000	5000	8000	ps	24
DQ and DM input hold time	tDH(base)	175	x	225	x	275	x	ps	15,16,17,20
DQ and DM input setup time	tDS(base)	100	x	100	x	150	x	ps	15,16,17,21
Control & Address input pulse width for each input	tIPW	0.6	x	0.6	x	0.6	x	tCK	
DQ and DM input pulse width for each input	tDIPW	0.35	x	0.35	x	0.35	x	tCK	
Data-out high-impedance time from CK/CK	tHZ	x	tAC max	x	tAC max	x	tAC max	ps	
DQS low-impedance time from CK/CK	tLZ(DQS)	tAC min	tAC max	tAC min	tAC max	tAC min	tAC max	ps	27
DQ low-impedance time from CK/CK	tLZ(DQ)	2*tAC min	tAC max	2* tAC min	tAC max	2* tAC min	tAC max	ps	27
DQS-DQ skew for DQS and associated DQ signals	tDQSQ	x	240	x	300	x	350	ps	22
DQ hold skew factor	tQHS	x	340	x	400	x	450	ps	21
DQ/DQS output hold time from DQS	tQH	tHP - tQHS	x	tHP - tQHS	x	tHP - tQHS	x	ps	
First DQS latching transition to associated clock edge	tDQSS	-0.25	0.25	-0.25	0.25	-0.25	0.25	tCK	
DQS input high pulse width	tDQSH	0.35	x	0.35	x	0.35	x	tCK	
DQS input low pulse width	tDQSL	0.35	x	0.35	x	0.35	x	tCK	
DQS falling edge to CK setup time	tDSS	0.2	x	0.2	x	0.2	x	tCK	
DQS falling edge hold time from CK	tDSH	0.2	x	0.2	x	0.2	x	tCK	



256Mb F-die DDR2 SDRAM

DDR2 SDRAM

Parameter	Symbol	DDR2-667		DDR2-533		DDR2-400		Units	Notes
		min	max	min	max	min	max		
Mode register set command cycle time	tMRD	2	x	2	x	2	x	tCK	
Write postamble	tWPST	0.4	0.6	0.4	0.6	0.4	0.6	tCK	19
Write preamble	tWPRE	0.35	x	0.35	x	0.35	x	tCK	
Address and control input hold time	tIH(base)	275	x	375	x	475	x	ps	14,16,18,23
Address and control input setup time	tIS(base)	200	x	250	x	350	x	ps	14,16,18,22
Read preamble	tRPRE	0.9	1.1	0.9	1.1	0.9	1.1	tCK	28
Read postamble	tRPST	0.4	0.6	0.4	0.6	0.4	0.6	tCK	28
Active to active command period for 1KB page size products	tRRD	7.5	x	7.5	x	7.5	x	ns	12
Active to active command period for 2KB page size products	tRRD	10	x	10	x	10	x	ns	12
Four Activate Window for 1KB page size products	tFAW	37.5		37.5		37.5		ns	
Four Activate Window for 2KB page size products	tFAW	50		50		50		ns	
CAS to CAS command delay	tCCD	2		2		2		tCK	
Write recovery time	tWR	15	x	15	x	15	x	ns	
Auto precharge write recovery + precharge time	tDAL	WR+tR P	x	WR+tR P	x	WR+tR P	x	tCK	23
Internal write to read command delay	tWTR	7.5	x	7.5	x	10	x	ns	33
Internal read to precharge command delay	tRTP	7.5		7.5		7.5		ns	11
Exit self refresh to a non-read command	tXSNR	tRFC + 10		tRFC + 10		tRFC + 10		ns	
Exit self refresh to a read command	tXSRD	200		200		200		tCK	
Exit precharge power down to any non-read command	tXP	2	x	2	x	2	x	tCK	
Exit active power down to read command	tXARD	2	x	2	x	2	x	tCK	9

Parameter	Symbol	DDR2-667		DDR2-533		DDR2-400		Units	Notes
		min	max	min	max	min	max		
Exit active power down to read command (slow exit, lower power)	tXARDS	7 - AL		6 - AL		6 - AL		tCK	9, 10
CKE minimum pulse width (high and low pulse width)	t ['] CKE	3		3		3		tCK	36
ODT turn-on delay	t ['] AOND	2	2	2	2	2	2	tCK	
ODT turn-on	t ['] AON	tAC(min)	tAC(max)+0.7	tAC(min)	tAC(max)+1	tAC(min)	tAC(max)+1	ns	13, 25
ODT turn-on(Power-Down mode)	t ['] AONPD	tAC(min)+2	2tCK+tAC(max)+1	tAC(min)+2	2tCK+tAC(max)+1	tAC(min)+2	2tCK+tAC(max)+1	ns	
ODT turn-off delay	t ['] AOFD	2.5	2.5	2.5	2.5	2.5	2.5	tCK	
ODT turn-off	t ['] AOF	tAC(min)	tAC(max)+0.6	tAC(min)	tAC(max)+0.6	tAC(min)	tAC(max)+0.6	ns	26
ODT turn-off (Power-Down mode)	t ['] AOFPD	tAC(min)+2	2.5tCK+tAC(max)+1	tAC(min)+2	2.5tCK+tAC(max)+1	tAC(min)+2	2.5tCK+tAC(max)+1	ns	
ODT to power down entry latency	tANPD	3		3		3		tCK	
ODT power down exit latency	tAXPD	8		8		8		tCK	
OCD drive mode output delay	tOIT	0	12	0	12	0	12	ns	
Minimum time clocks remains ON after CKE asynchronously drops LOW	tDelay	tIS+tCK+tIH		tIS+tCK+tIH		tIS+tCK+tIH		ns	24

General notes, which may apply for all AC parameters

1. Slew Rate Measurement Levels

- a. Output slew rate for falling and rising edges is measured between $V_{TT} - 250\text{ mV}$ and $V_{TT} + 250\text{ mV}$ for single ended signals. For differential signals (e.g. $DQS - \overline{DQS}$) output slew rate is measured between $DQS - \overline{DQS} = -500\text{ mV}$ and $DQS - \overline{DQS} = +500\text{ mV}$. Output slew rate is guaranteed by design, but is not necessarily tested on each device.
- b. Input slew rate for single ended signals is measured from dc-level to ac-level: from $V_{IL}(\text{dc})$ to $V_{IH}(\text{ac})$ for rising edges and from $V_{IH}(\text{dc})$ and $V_{IL}(\text{ac})$ for falling edges.
For differential signals (e.g. $CK - \overline{CK}$) slew rate for rising edges is measured from $CK - \overline{CK} = -250\text{ mV}$ to $CK - \overline{CK} = +500\text{ mV}$ (250mV to -500 mV for falling edges).
- c. VID is the magnitude of the difference between the input voltage on CK and the input voltage on \overline{CK} , or between DQS and \overline{DQS} for differential strobe.

2. DDR2 SDRAM AC timing reference load

Following figure represents the timing reference load used in defining the relevant timing parameters of the part. It is not intended to be either a precise representation of the typical system environment or a depiction of the actual load presented by a production tester. System designers will use IBIS or other simulation tools to correlate the timing reference load to a system environment. Manufacturers will correlate to their production test conditions (generally a coaxial transmission line terminated at the tester electronics).

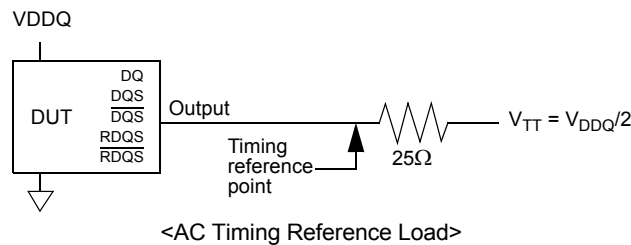

The output timing reference voltage level for single ended signals is the crosspoint with V_{TT} . The output timing reference voltage level for differential signals is the crosspoint of the true (e.g. DQS) and the complement (e.g. \overline{DQS}) signal.

3. DDR2 SDRAM output slew rate test load

Output slew rate is characterized under the test conditions as shown in the following figure.

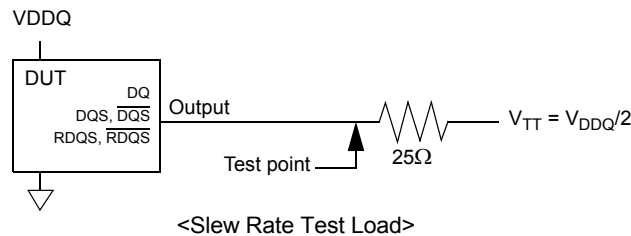

4. Differential data strobe

DDR2 SDRAM pin timings are specified for either single ended mode or differential mode depending on the setting of the EMRS "Enable DQS" mode bit; timing advantages of differential mode are realized in system design. The method by which the DDR2 SDRAM pin timings are measured is mode dependent. In single ended mode, timing relationships are measured relative to the rising or falling edges of DQS crossing at VREF. In differential mode, these timing relationships are measured relative to the crosspoint of DQS and its complement, \overline{DQS} . This distinction in timing methods is guaranteed by design and characterization. Note that when differential data strobe mode is disabled via the EMRS, the complementary pin, \overline{DQS} , must be tied externally to VSS through a 20 ohm to 10 K ohm resistor to insure proper operation.

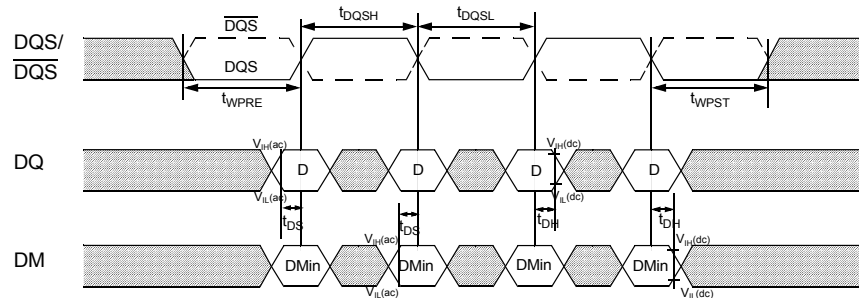

<Data input (write) timing>

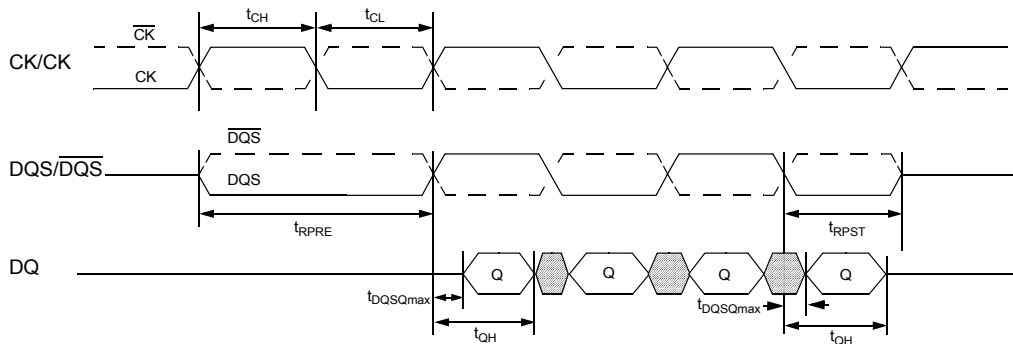

<Data output (read) timing>

5. AC timings are for linear signal transitions.
6. These parameters guarantee device behavior, but they are not necessarily tested on each device. They may be guaranteed by device design or tester correlation.
7. All voltages are referenced to VSS.
8. Tests for AC timing, IDD, and electrical (AC and DC) characteristics, may be conducted at nominal reference/supply voltage levels, but the related specifications and device operation are guaranteed for the full voltage range specified.

Specific Notes for dedicated AC parameters

- 9. User can choose which active power down exit timing to use via MRS(bit 12). tXARD is expected to be used for fast active power down exit timing. tXARDS is expected to be used for slow active power down exit timing.
- 10. AL = Additive Latency
- 11. This is a minimum requirement. Minimum read to precharge timing is AL + BL/2 providing the tRTP and tRAS(min) have been satisfied.
- 12. A minimum of two clocks (2 * tCK) is required irrespective of operating frequency
- 13. Timings are guaranteed with command/address input slew rate of 1.0 V/ns.
- 14. These parameters guarantee device behavior, but they are not necessarily tested on each device. They may be guaranteed by device design or tester correlation.
- 15. Timings are guaranteed with data, mask, and (DQS/RDQS in singled ended mode) input slew rate of 1.0 V/ns.
- 16. Timings are guaranteed with CK/CK differential slew rate of 2.0 V/ns. Timings are guaranteed for DQS signals with a differential slew rate of 2.0 V/ns in differential strobe mode and a slew rate of 1V/ns in single ended mode.
- 17. tDS and tDH derating for DDR2-400 and DDR2-533

ΔtDS, ΔtDH Derating Values (ALL units in 'ps', Note 1 applies to entire Table)																			
DQS, \overline{DQS} Differential Slew Rate																			
		4.0 V/ns		3.0 V/ns		2.0 V/ns		1.8 V/ns		1.6 V/ns		1.4V/ns		1.2V/ns		1.0V/ns		0.8V/ns	
		ΔtD S	ΔtD H	ΔtD S	ΔtD H	ΔtD S	ΔtD H	ΔtD S	ΔtD H	ΔtD S	ΔtD H	ΔtD S	ΔtD H	ΔtD S	ΔtD H	ΔtD S	ΔtD H	ΔtD S	ΔtD H
DQ Slew rate V/ns	2.0	125	45	125	45	125	45	-	-	-	-	-	-	-	-	-	-	-	-
	1.5	83	21	83	21	83	21	95	33	-	-	-	-	-	-	-	-	-	-
	1.0	0	0	0	0	0	0	12	12	24	24	-	-	-	-	-	-	-	-
	0.9	-	-	-11	-14	-11	-14	1	-2	13	10	25	22	-	-	-	-	-	-
	0.8	-	-	-	-	-25	-31	-13	-19	-1	-7	11	5	23	17	-	-	-	-
	0.7	-	-	-	-	-	-	-31	-42	-19	-30	-7	-18	5	-6	17	6	-	-
	0.6	-	-	-	-	-	-	-	-	-43	-59	-31	-47	-19	-35	-7	-23	5	-11
	0.5	-	-	-	-	-	-	-	-	-	-	-74	-89	-62	-77	-50	-65	-38	-53
	0.4	-	-	-	-	-	-	-	-	-	-	-	-	-127	-140	-115	-128	-103	-116

For all input signals the total tDS (setup time) and tDH (hold time) required is calculated by adding the datasheet tDS(base) and tDH(base) value to the delta tDS and delta tDH derating value respectively. Example: tDS (total setup time) = tDS(base) + delta tDS.

18. tIS and tIH (input setup and hold) derating.

		tIS, tIH Derating Values for DDR2-400, DDR2-533							
		CK,CK Differential Slew Rate						Units	Notes
		2.0 V/ns		1.5 V/ns		1.0 V/ns			
		Δt_{IS}	Δt_{IH}	Δt_{IS}	Δt_{IH}	Δt_{IS}	Δt_{IH}		
Command/Address Slew rate (V/ns)	4.0	+187	+94	+217	+124	+247	+154	ps	1
	3.5	+179	+89	+209	+119	+239	+149	ps	1
	3.0	+167	+83	+197	+113	+227	+143	ps	1
	2.5	+150	+75	+180	+105	+210	+135	ps	1
	2.0	+125	+45	+155	+75	+185	+105	ps	1
	1.5	+83	+21	+113	+51	+143	+81	ps	1
	1.0	0	0	+30	+30	+60	60	ps	1
	0.9	-11	-14	+19	+16	+49	+46	ps	1
	0.8	-25	-31	+5	-1	+35	+29	ps	1
	0.7	-43	-54	-13	-24	+17	+6	ps	1
	0.6	-67	-83	-37	-53	-7	-23	ps	1
	0.5	-110	-125	-80	-95	-50	-65	ps	1
	0.4	-175	-188	-145	-158	-115	-128	ps	1
	0.3	-285	-292	-255	-262	-225	-232	ps	1
	0.25	-350	-375	-320	-345	-290	-315	ps	1
0.2	-525	-500	-495	-470	-465	-440	ps	1	
0.15	-800	-708	-770	-678	-740	-648	ps	1	

		Δt_{IS} and Δt_{IH} Derating Values for DDR2-667, DDR2-800							
		CK,CK Differential Slew Rate						Units	Notes
		2.0 V/ns		1.5 V/ns		1.0 V/ns			
		Δt_{IS}	Δt_{IH}	Δt_{IS}	Δt_{IH}	Δt_{IS}	Δt_{IH}		
Command/Address Slew rate (V/ns)	4.0	+150	+94	+180	+124	+210	+154	ps	1
	3.5	+143	+89	+173	+119	+203	+149	ps	1
	3.0	+133	+83	+163	+113	+193	+143	ps	1
	2.5	+120	+75	+150	+105	+180	+135	ps	1
	2.0	+100	+45	+130	+75	+160	+105	ps	1
	1.5	+67	+21	+97	+51	+127	+81	ps	1
	1.0	0	0	+30	+30	+60	+60	ps	1
	0.9	-5	-14	+25	+16	+55	+46	ps	1
	0.8	-13	-31	+17	-1	+47	+29	ps	1
	0.7	-22	-54	+8	-24	+38	+6	ps	1
	0.6	-34	-83	-4	-53	+26	-23	ps	1
	0.5	-60	-125	-30	-95	0	-65	ps	1
	0.4	-100	-188	-70	-158	-40	-128	ps	1
	0.3	-168	-292	-138	-262	-108	-232	ps	1
	0.25	-200	-375	-170	-345	-140	-315	ps	1
0.2	-325	-500	-295	-470	-265	-440	ps	1	
0.15	-517	-708	-487	-678	-457	-648	ps	1	
0.1	-1000	-1125	-970	-1095	-940	-1065	ps	1	

For all input signals the total tIS (setup time) and tIH (hold time) required is calculated by adding the datasheet tIS(base) and tIH(base) value to the delta tIS and delta tIH derating value respectively. Example:
 $tIS(\text{total setup time}) = tIS(\text{base}) + \text{delta } tIS$

19. The maximum limit for this parameter is not a device limit. The device will operate with a greater value for this parameter, but system performance (bus turnaround) will degrade accordingly.

20. MIN (tCL, tCH) refers to the smaller of the actual clock low time and the actual clock high time as provided to the device (i.e. this value can be greater than the minimum specification limits for tCL and tCH). For example, tCL and tCH are = 50% of the period, less the half period jitter (tJIT(HP)) of the clock source, and less the half period jitter due to crosstalk (tJIT(crosstalk)) into the clock traces.

21. $tQH = tHP - tQHS$, where:

tHP = minimum half clock period for any given cycle and is defined by clock high or clock low (tCH, tCL).

tQHS accounts for:

- 1) The pulse duration distortion of on-chip clock circuits; and
- 2) The worst case push-out of DQS on one transition followed by the worst case pull-in of DQ on the next transition, both of which are, separately, due to data pin skew and output pattern effects, and p-channel to n-channel variation of the output drivers.

22. tDQSQ: Consists of data pin skew and output pattern effects, and p-channel to n-channel variation of the output drivers as well as output slew rate mismatch between $\overline{DQS} / \overline{DQS}$ and associated DQ in any given cycle.

23. $DAL = WR + RU\{tRP(\text{ns})/tCK(\text{ns})\}$, where RU stands for round up.

WR refers to the tWR parameter stored in the MRS. For tRP, if the result of the division is not already an integer, round up to the next highest integer. tCK refers to the application clock period.

Example: For DDR533 at tCK = 3.75ns with tWR programmed to 4 clocks.

$tDAL = 4 + (15 \text{ ns} / 3.75 \text{ ns}) \text{ clocks} = 4 + (4) \text{ clocks} = 8 \text{ clocks}$.

24. The clock frequency is allowed to change during self-refresh mode or precharge power-down mode. In case of clock frequency change during precharge power-down, a specific procedure is required as described in DDR2 device operation

25. ODT turn on time min is when the device leaves high impedance and ODT resistance begins to turn on. ODT turn on time max is when the ODT resistance is fully on. Both are measured from tAOND.

26. ODT turn off time min is when the device starts to turn off ODT resistance.

ODT turn off time max is when the bus is in high impedance. Both are measured from tAOFD.

27. tHZ and tLZ transitions occur in the same access time as valid data transitions. These parameters are referenced to a specific voltage level which specifies when the device output is no longer driving (tHZ), or begins driving (tLZ). Following figure shows a method to calculate the point when device is no longer driving (tHZ), or begins driving (tLZ) by measuring the signal at two different voltages. The actual voltage measurement points are not critical as long as the calculation is consistent.

28. tRPST end point and tRPRE begin point are not referenced to a specific voltage level but specify when the device output is no longer driving (tRPST), or begins driving (tRPRE). Following figure shows a method to calculate these points when the device is no longer driving (tRPST), or begins driving (tRPRE) by measuring the signal at two different voltages. The actual voltage measurement points are not critical as long as the cal-

ulation is consistent.

These notes are referenced in the "Timing parameters by speed grade" tables for DDR2-400/533/667 and DDR2-800.

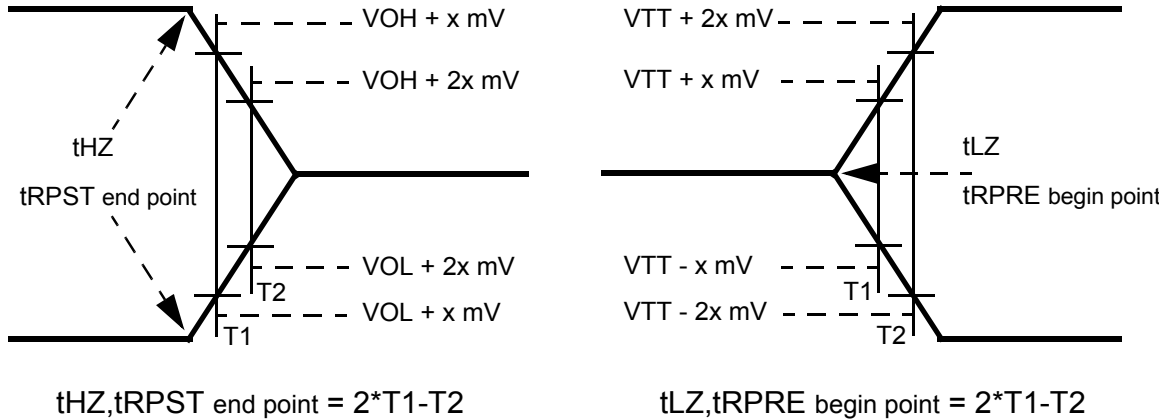

<Test method for tLZ, tHZ, tRPRE and tRPST>

29. Input waveform timing with differential data strobe enabled MR[bit10]=0, is referenced from the input signal crossing at the $V_{IH(ac)}$ level to the differential data strobe crosspoint for a rising signal, and from the input signal crossing at the $V_{IL(ac)}$ level to the differential data strobe crosspoint for a falling signal applied to the device under test.

30. Input waveform timing with differential data strobe enabled MR[bit10]=0, is referenced from the input signal crossing at the $V_{IH(dc)}$ level to the differential data strobe crosspoint for a rising signal and $V_{IL(dc)}$ to the differential data strobe crosspoint for a falling signal applied to the device under test.

Differential Input waveform timing

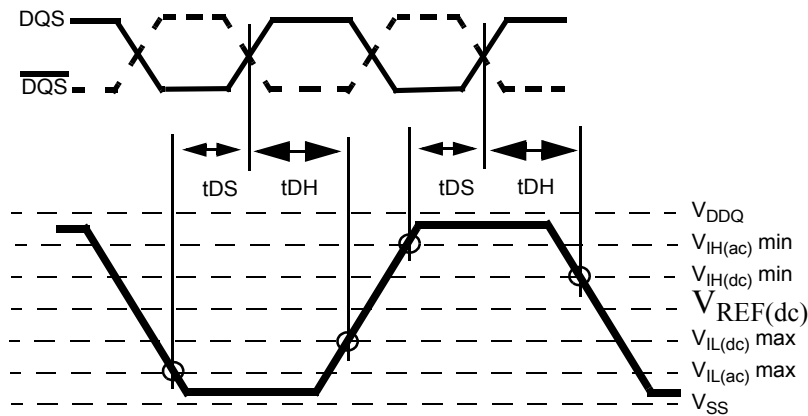

31. Input waveform timing is referenced from the input signal crossing at the $V_{IH(ac)}$ level for a rising signal and $V_{IL(ac)}$ for a falling signal applied to the device under test.

32. Input waveform timing is referenced from the input signal crossing at the $V_{IH(dc)}$ level for a rising signal and $V_{IL(dc)}$ for a falling signal applied to the device under test.

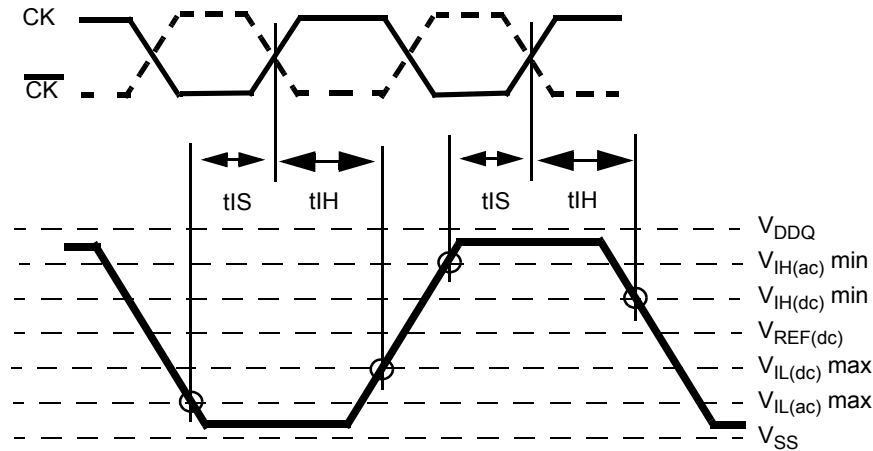

33. tWTR is at least two clocks ($2 * tCK$) independent of operation frequency.

34. Input waveform timing with single-ended data strobe enabled $MR[\text{bit}10] = 1$, is referenced from the input signal crossing at the $V_{IH(ac)}$ level to the single-ended data strobe crossing $V_{IH/L(dc)}$ at the start of its transition for a rising signal, and from the input signal crossing at the $V_{IL(ac)}$ level to the single-ended data strobe crossing $V_{IH/L(dc)}$ at the start of its transition for a falling signal applied to the device under test. The DQS signal must be monotonic between $V_{il(dc)max}$ and $V_{ih(dc)min}$.

35. Input waveform timing with single-ended data strobe enabled $MR[\text{bit}10] = 1$, is referenced from the input signal crossing at the $V_{IH(dc)}$ level to the single-ended data strobe crossing $V_{IH/L(ac)}$ at the end of its transition for a rising signal, and from the input signal crossing at the $V_{IL(dc)}$ level to the single-ended data strobe crossing $V_{IH/L(ac)}$ at the end of its transition for a falling signal applied to the device under test. The DQS signal must be monotonic between $V_{il(dc)max}$ and $V_{ih(dc)min}$.

36. tCKEmin of 3 clocks means CKE must be registered on three consecutive positive clock edges. CKE must remain at the valid input level the entire time it takes to achieve the 3 clocks of registration. Thus, after any cKE transition, CKE may not transition from its valid level during the time period of $t_{IS} + 2 * tCK + t_{IH}$.

Revision History

Version 1.0 (Jan. 2004)

- Initial Release

Version 1.1 (Jun. 2004)

- Added Lead-Free part number in ordering information.
- Changed IDD2P
- Corrected Typo

Version 1.2 (Aug. 2004)

- Corrected the part number in ordering information.

Version 1.3 (Jan. 2005)

- Revised current test AC spec condition
- Added derating table

Version 1.4 (Jan. 2005)

- Corrected typo

Version 1.5 (Feb. 2005)

- Revised Input AC Logic Level for DDR2-667