

M/A-COM 0.5W X/Ku-Band Power Amplifier

8.0-12.0 GHz

MAAPGM0034

Preliminary Information

8.0-12.0 GHz GaAs MMIC Amplifier

Features

- ◆ 8.0-12.0 GHz Operation
- ◆ 0.5 Watt Saturated Output Power Level
- ◆ Variable Drain Voltage (4-10V) Operation
- ◆ Self-Aligned MSAG[®] MESFET Process
- ◆ High Performance Ceramic Bolt Down Package

Primary Applications

- ◆ Point-to-Point Radio
- ◆ Weather Radar
- ◆ Airborne Radar

Description

The MAAPGM0034 is a packaged, 2-stage, 0.5 W power amplifier with on-chip bias networks in a bolt down ceramic package, allowing easy assembly. This product is fully matched to 50 ohms on both the input and output. It can be used as a power amplifier stage or as a driver stage in high power applications.

Each device is 100% RF tested to ensure performance compliance. The part is fabricated using M/A-COM's GaAs Multifunction Self-Aligned Gate (MSAG[®]) MESFET Process.

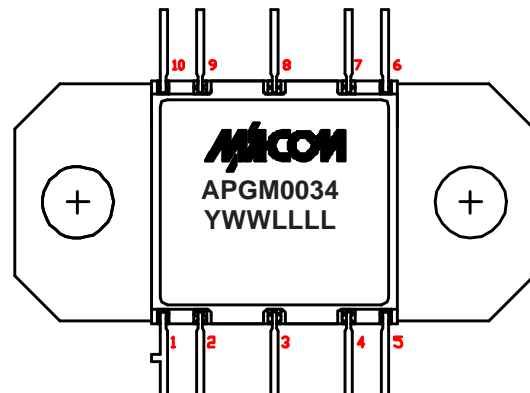

Pin Number	Description
1	No Connection
2	No Connection
3	RF IN
4	No Connection
5	V _{GG}
6	No Connection
7	No Connection
8	RF OUT
9	No Connection
10	V _{DD}

Maximum Operating Conditions ¹

Parameter	Symbol	Absolute Maximum	Units
Input Power	P _{IN}	21.0	dBm
Drain Supply Voltage	V _{DD}	+12.0	V
Gate Supply Voltage	V _{GG}	-3.0	V
Quiescent Drain Current (No RF)	I _{DQ}	150	mA
Quiescent DC Power Dissipated (No RF)	P _{DISS}	1.5	W
Junction Temperature	T _J	180	°C
Storage Temperature	T _{STG}	-55 to +150	°C

1. Operation outside of these ranges may reduce product reliability.

Recommended Operating Conditions

Characteristic	Symbol	Min	Typ	Max	Unit
Drain Supply Voltage	V_{DD}	4.0	8.0	10.0	V
Gate Supply Voltage	V_{GG}	-2.3	-2.0	-1.5	V
Input Power	P_{IN}		16.0	19.0	dBm
Junction Temperature	T_J			150	°C
Thermal Resistance	T_{JC}		58.6		°C/W
MMIC Base Temperature	T_B			Note 2	°C

2. Maximum MMIC Base Temperature = 150°C — $T_{JC} * V_{DD} * I_{DQ}$

Electrical Characteristics: $T_B = 40^\circ\text{C}^3$, $Z_0 = 50 \Omega$, $V_{DD} = 10\text{V}$, $V_{GG} = -1.8\text{V}$, $P_{in} = 16 \text{ dBm}$, $R_G = 604\Omega$

Parameter	Symbol	Typical	Units
Bandwidth	f	8.0-12.0	GHz
Output Power	POUT	27.5	dBm
Power Added Efficiency	PAE	30	%
1-dB Compression Point	P1dB	27	dBm
Small Signal Gain	G	14.5	dB
Input VSWR	VSWR	2.5:1	
Output VSWR	VSWR	2.5:1	
Gate Supply Current	I_{GG}	< 2	mA
Drain Supply Current	I_{DD}	< 200	mA
Noise Figure	NF	8.5	dB
2 nd Harmonic	2f	-28	dBc
3 rd Harmonic	3f	-35	dBc
Output Third Order Intercept	OTOI	33	dBm
3 rd Order Intermodulation Distortion, Single Carrier Level = 17 dBm	IM3	-13	dBm
5 th Order Intermodulation Distortion, Single Carrier Level = 17 dBm	IM5	-36	dBm

3. T_B = MMIC Base Temperature

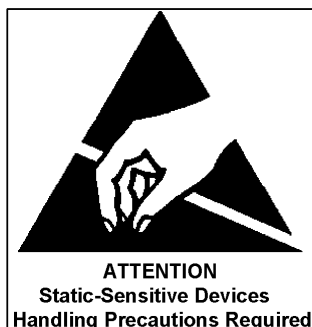

Operating Instructions

This device is static sensitive. Please handle with care. To operate the device, follow these steps.

1. Apply $V_{GG} = -1.8 \text{ V}$, $V_{DD} = 0 \text{ V}$.
2. Ramp V_{DD} to desired voltage, typically 8 V.
3. Adjust V_{GG} to set I_{DQ} , (approximately @ -1.8V).
4. Set RF input.
5. Power down sequence in reverse. Turn V_{GG} off last.

Specifications subject to change without notice.

Email: macom_adbu_ics@tycoelectronics.com

- North America: Tel. (800) 366-2266
- Asia/Pacific: Tel.+81-44-844-8296, Fax +81-44-844-8298
- Europe: Tel. +44 (1908) 574 200, Fax+44 (1908) 574 300

tyco / Electronics

MACOM

Visit www.macom.com for additional data sheets and product information.

0.5W X/Ku-Band Power Amplifier

MAAPGM0034

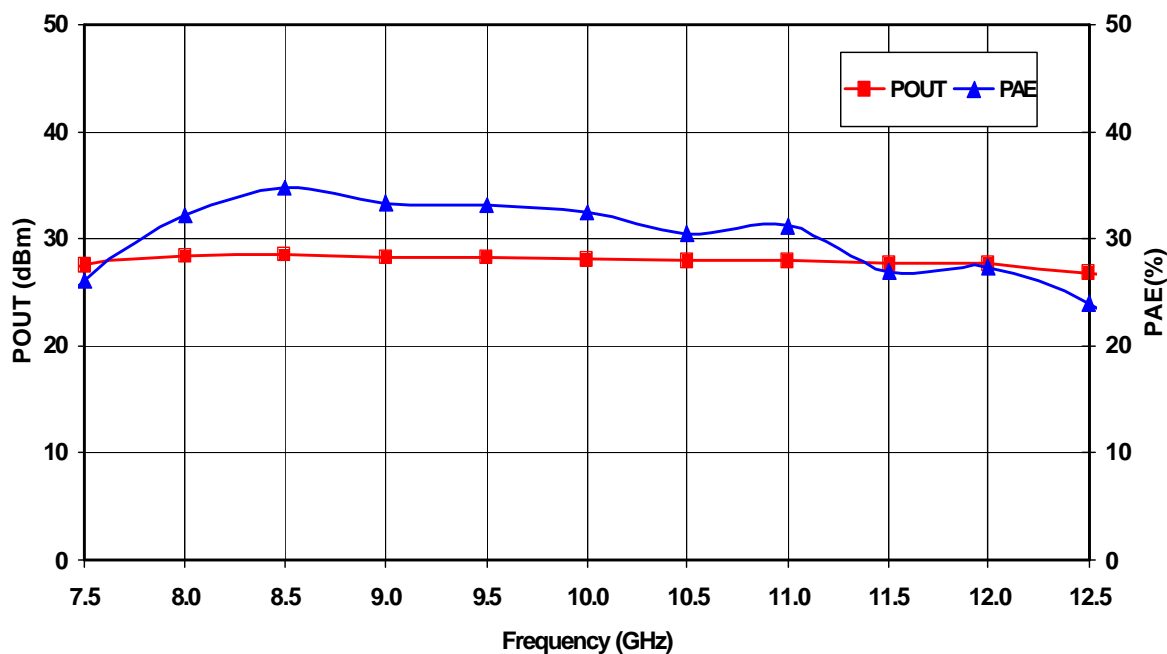

Figure 1. Output Power and Power Added Efficiency vs. Frequency at $V_{DD} = 10V$ and $P_{in} = 16$ dBm.

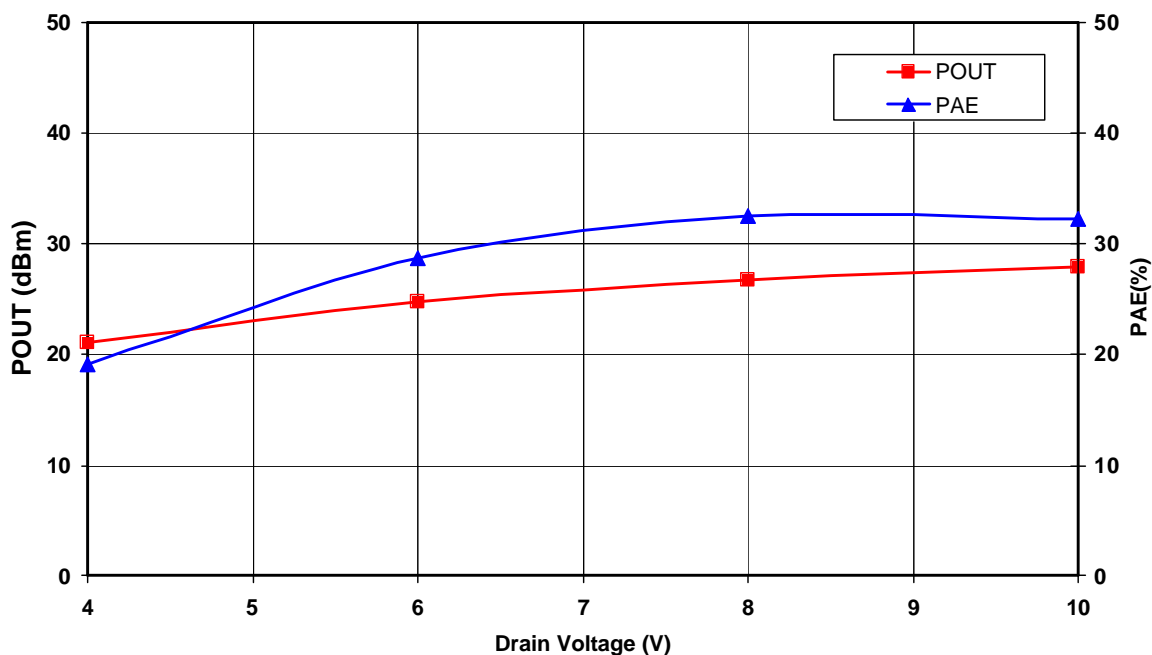

Figure 2. Saturated Output Power and Power Added Efficiency vs. Drain Voltage at $f_0 = 10$ GHz.

Specifications subject to change without notice.

Email: macom_adbu_ics@tycoelectronics.com

- North America: Tel. (800) 366-2266
- Asia/Pacific: Tel.+81-44-844-8296, Fax +81-44-844-8298
- Europe: Tel. +44 (1908) 574 200, Fax+44 (1908) 574 300

tyco / Electronics

MACOM

Visit www.macom.com for additional data sheets and product information.

0.5W X/Ku-Band Power Amplifier

MAAPGM0034

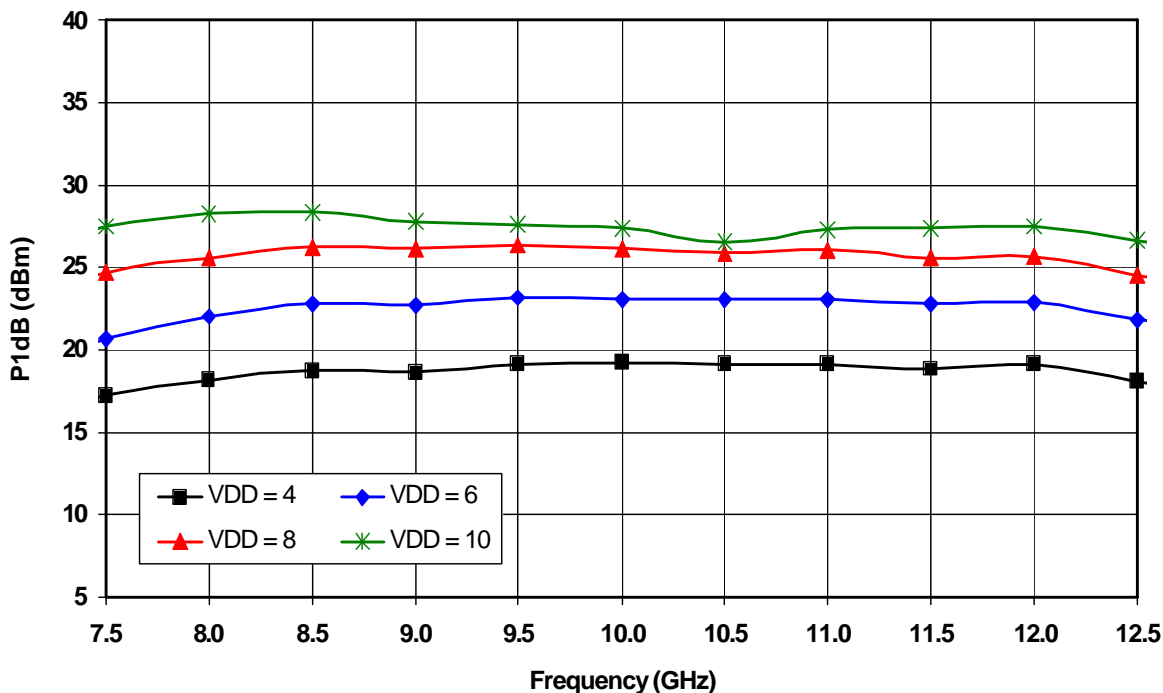

Figure 3. 1dB Compression Point vs. Drain Voltage

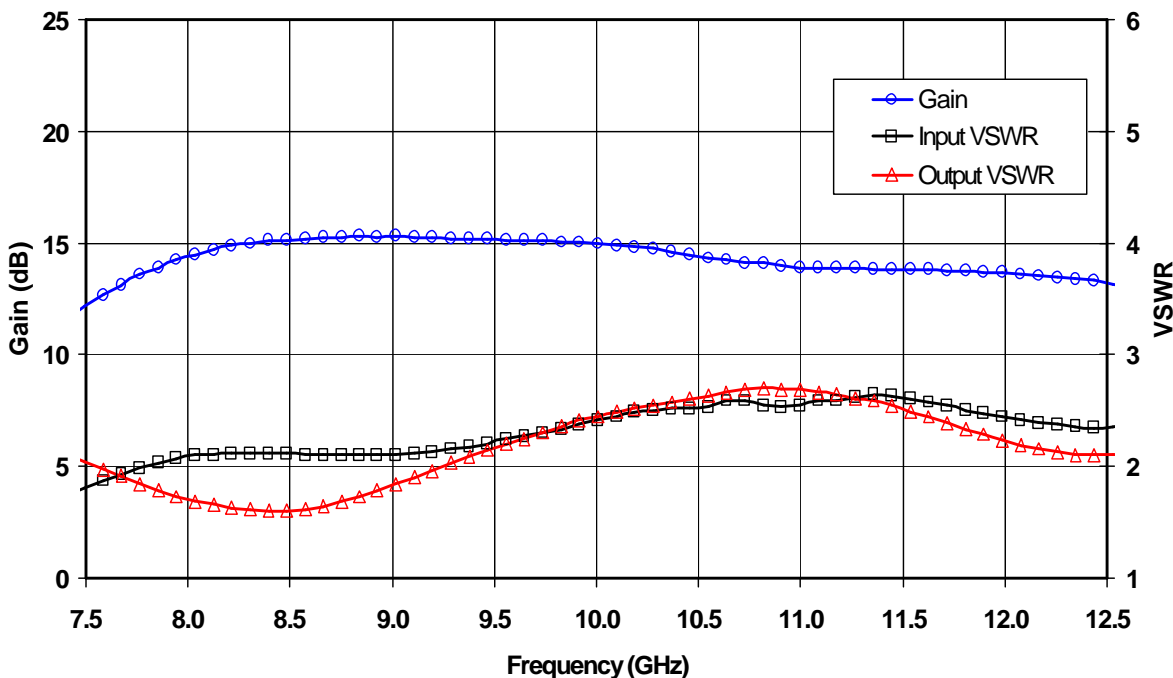

Figure 4. Small Signal Gain and VSWR vs. Frequency at VDD = 10V.

Specifications subject to change without notice.

Email: macom_adbu_ics@tycoelectronics.com

- North America: Tel. (800) 366-2266
- Asia/Pacific: Tel.+81-44-844-8296, Fax +81-44-844-8298
- Europe: Tel. +44 (1908) 574 200, Fax+44 (1908) 574 300



Visit www.macom.com for additional data sheets and product information.

0.5W X/Ku-Band Power Amplifier

MAAPGM0034

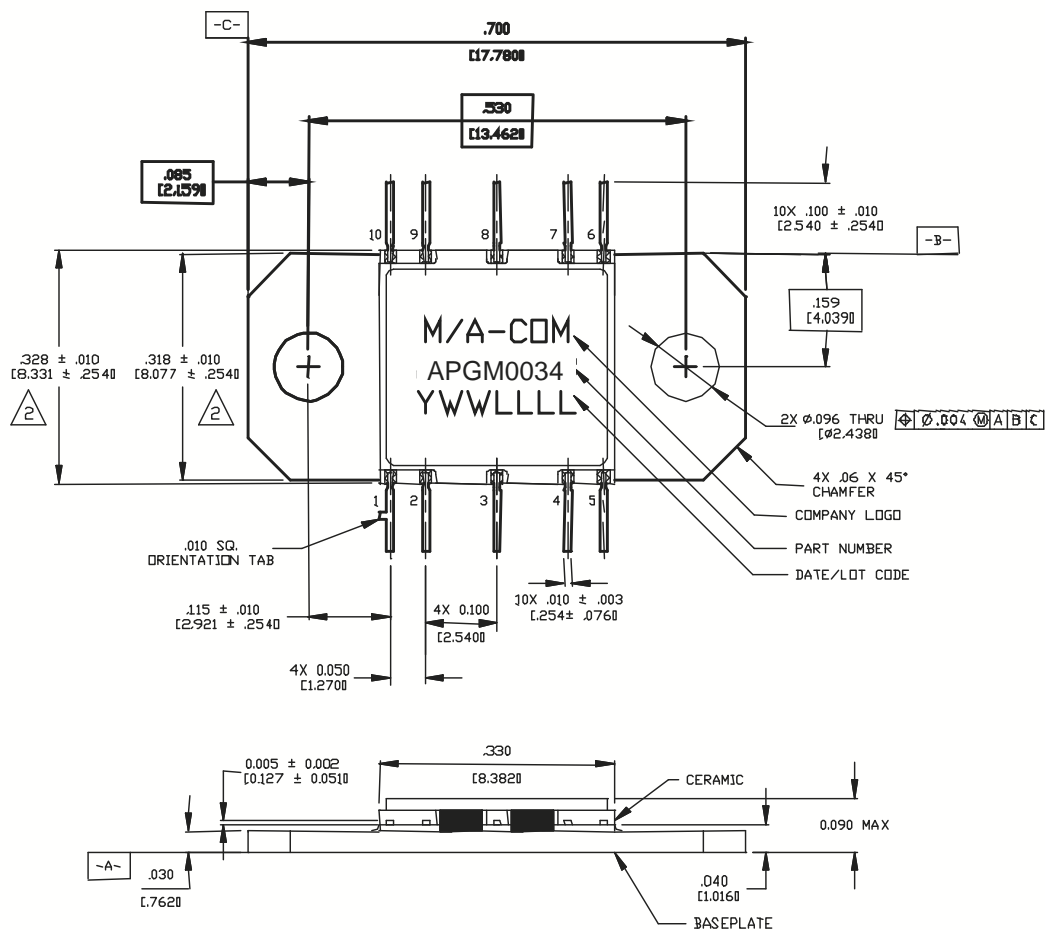

Figure 5. CR-15 Package Dimensions

The CR-15 is a high frequency, low thermal resistance package. The package consists of a cofired ceramic construction with a copper-tungsten base and iron-nickel-cobalt leads. The finish consists of electrolytic gold over nickel plate.

Specifications subject to change without notice.

Email: macom_adbu_ics@tycoelectronics.com

- North America: Tel. (800) 366-2266
- Asia/Pacific: Tel.+81-44-844-8296, Fax +81-44-844-8298
- Europe: Tel. +44 (1908) 574 200, Fax+44 (1908) 574 300

tyco / Electronics

M/A-COM

Visit www.macom.com for additional data sheets and product information.

Figure 6. Recommended Bias Configuration

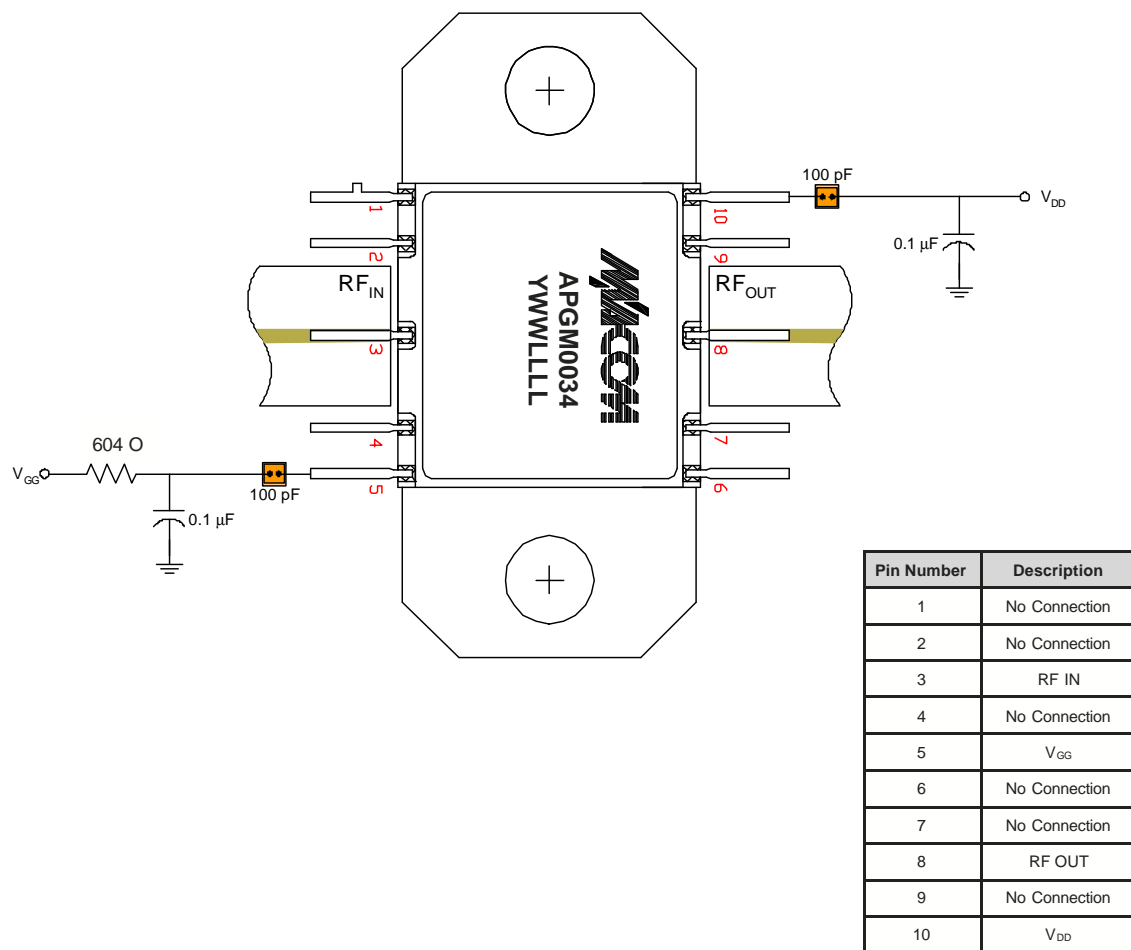
**Assembly Instructions:**

This flange mount style package provides a robust interface between a highly integrated GaAs MMIC device and a circuit board which may be assembled using conventional surface mount techniques. A thin shim made of a thermally and electrically conductive, ductile material should be used prior to installation of the CR-15 to improve the thermal and electrical performance of the package to housing interface. Refer to **M/A-COM Application Note #M567*** for more information.

For applications where surface mount components are to be installed after the CR-15 installation, this package will not be damaged when subjected to typical convection or IR oven reflow profiles. Refer to **M/A-COM Application Note #M538*** for maximum allowable reflow time and temperature. Alternatively, the package leads may be individually soldered. Whether an iron or hot gas soldering equipment is used, care should be taken to insure that the temperature is well controlled and electric static discharge (ESD) safe.

Biasing Note: Must apply negative bias to V_{GG} before applying positive bias to V_{DD} to prevent damage to amplifier.

* Application Notes can be found by going to the Site Search Page on M/A-COM's web page (<http://www.macom.com/search/search.jsp>) and searching for the required Application Note.

Specifications subject to change without notice.

Email: macom_adbu_ics@tycoelectronics.com

- North America: Tel. (800) 366-2266
- Asia/Pacific: Tel.+81-44-844-8296, Fax +81-44-844-8298
- Europe: Tel. +44 (1908) 574 200, Fax+44 (1908) 574 300

tyco / Electronics

M/A-COM

Visit www.macom.com for additional data sheets and product information.