

**1 Watt Power Amplifier**  
**4.9 - 6.0 GHz**

**MAAPSM0008**  
**V3**

**Features**

- U-NII and Hiperlan Applications
- Saturated Output Power: 31.5 dBm at +7 V
- Saturated Output Power: 29.0 dBm at +5 V
- 20.5 dB Gain
- No External RF Matching
- 4 mm 16-Lead PQFN Package
- Meets 802.11a Linearity Requirements

**Description**

The MAAPSM0008 is a two-stage power amplifier mounted in a standard outline, 4 mm 16-lead PQFN plastic package, designed specifically for the U-NII, MMAC, and Hiperlan bands (4.9 GHz - 6.0 GHz). The MAAPSM0008 has fully matched 50 ohms input and output, eliminating the need for external RF tuning components.

M/A-COM fabricates the MAAPSM0008 using a self-aligned gate MESFET process to realize high power efficiency and small size. The process features full passivation for performance and reliability.

**Operating The MAAPSM0008**

The MAAPSM0008 is static sensitive. Please handle with care. To operate the device, follow these steps.

1. Apply  $V_{GG} = -1.8\text{ V}$ ,  $V_{DD} = 0\text{ V}$ .
2. Ramp  $V_{DD}$  to desired voltage, typically 5 to 7 V.
3. Adjust  $V_{GG}$  to set  $I_{DQ}$ , (approximately  $-1.8\text{ V}$ ).
4. Set RF input.
5. Power down sequence in reverse. Turn gate voltage off last.

**Ordering Information**

Part Number	Package
MAAPSM0008TR	1000-piece reel
MAAPSM0008TR-3000	3000-piece reel
MAAPSM0008SMB	Sample Test Board

Note: Reference Application Note M513 for reel size information.

**Functional Schematic**

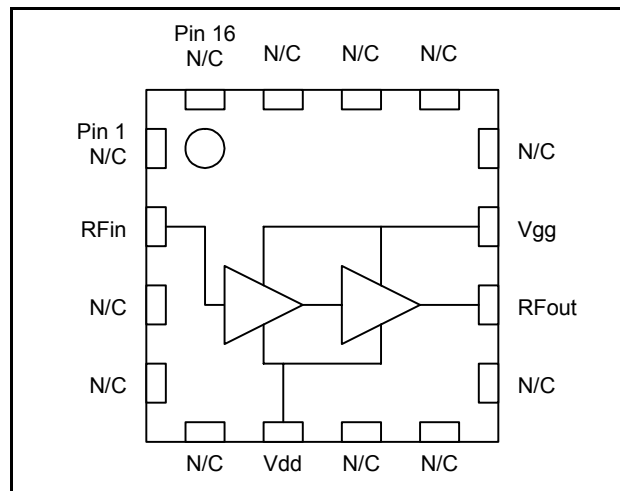

**Pin Configuration**

Pin No.	Function	Description
1	NC	No connection
2	RF <sub>IN</sub>	RF input to the amplifier. DC block on-chip. 50 ohm input.
3	NC	No connection
4	NC	No connection
5	NC	No connection
6	V <sub>dd</sub>	Positive voltage supply to both stages
7	NC	No connection
8	NC	No connection
9	NC	No connection
10	RF <sub>OUT</sub>	RF output of the amplifier. DC block on-chip. 50 Ohm output.
11	V <sub>gg</sub>	Negative voltage supply to the gates of both stages
12	NC	No connection
13	NC	No connection
14	NC	No connection
15	NC	No connection
16	NC	
17	Paddle *	RF and DC Ground

\* The exposed pad centered on the package bottom must be connected to RF and DC ground.

- **North America** Tel: 800.366.2266 / Fax: 978.366.2266
- **Europe** Tel: 44.1908.574.200 / Fax: 44.1908.574.300
- **Asia/Pacific** Tel: 81.44.844.8296 / Fax: 81.44.844.8298

Visit [www.macom.com](http://www.macom.com) for additional data sheets and product information.

**1 Watt Power Amplifier  
4.9 - 6.0 GHz**

**MAAPSM0008  
V3**

**Electrical Specifications:  $T_C = 40\text{ }^\circ\text{C}$ ,  $V_{DD} = 7.0\text{ V}$ ,  $V_G = -1.8\text{ V}$  (unless otherwise specified)**

Parameter	Test Conditions	Units	Min.	Typ.	Max.	Typ. @ $V_{DD} + 5\text{ V}$
Frequency	—	GHz	4.9	—	6.0	—
Input VSWR	F = 5.825 GHz, Pin = +14 dBm	—	—	1.5:1	2.0:1	1.5:1
Gain	F = 5.825 GHz, Pin = 0 dBm	dB	18.0	20.5	—	20.5
P1dB	F = 5.825 GHz	dBm	—	29.5	—	28.0
Saturated Power	F = 5.825 GHz, Pin = +14 dBm	dBm	29.2	31.5	—	30.0
Drain Current at Psat	F = 5.825 GHz, Pin = +14 dBm	mA	—	500	600	500
2nd Harmonics 3rd Harmonics	Output Power = 29.5 dBm	dBc dBc	— —	-40 -70	— —	-40 -70
Thermal resistance <sup>1</sup>	2 <sup>nd</sup> Stage Only	$^\circ\text{C/W}$	—	31	—	31
Third-Order Intercept Point		dBm	—	40	—	38
Stability	+3.0 V < $V_{DD}$ < +10.0 V, $P_{IN}$ < +14 dBm, VSWR < 6:1, -25 $^\circ\text{C}$ < $T_C$ < 85 $^\circ\text{C}$ , RBW = 3 MHz max. hold	—	All spurs < -70 dBc			—
Noise Figure	F = 5.825 GHz	dB	—			—

1. When using the thermal resistance, you must use the power dissipated by the second stage only. Not the total power dissipated. The second stage dissipates 80% of the total power due to its periphery.

**Recommended Operating Conditions <sup>2,3</sup>**

Characteristic	Symbol	Unit	Min	Typ	Max
Drain Voltage	$V_{DD}$	V	4.5	7.0	8.0
Gate Voltage <sup>2</sup>	$V_{GG}$	V	-2.5	-1.8	-1.0
Input Power	$P_{IN}$	dBm		—	15
Gate Current	$I_{GG}$	mA	-4	1	+4
Case Temperature	$T_C$	$^\circ\text{C}$	-40	25	85

2. Operation outside of these ranges may reduce product reliability.
3. A 100 E-Series resistor should be used in the gate voltage line.

**Absolute Maximum Ratings <sup>4</sup>**

Parameter	Absolute Maximum
Max Input Power (4.9 - 6 GHz)	+ 15 dBm
Operating Voltages	+10 volts
Operating Temperature	-40 $^\circ\text{C}$ to +70 $^\circ\text{C}$
Channel Temperature	+150 $^\circ\text{C}$
Storage Temperature	-40 $^\circ\text{C}$ to +150 $^\circ\text{C}$

4. Exceeding any one or combination of these limits may cause permanent damage.

**Handling Procedures**

Please observe the following precautions to avoid damage:

**Static Sensitivity**

Gallium Arsenide Integrated Circuits are sensitive to electrostatic discharge (ESD) and can be damaged by static electricity. Proper ESD control techniques should be used when handling these devices.

**Application Information**

**Sample Board**

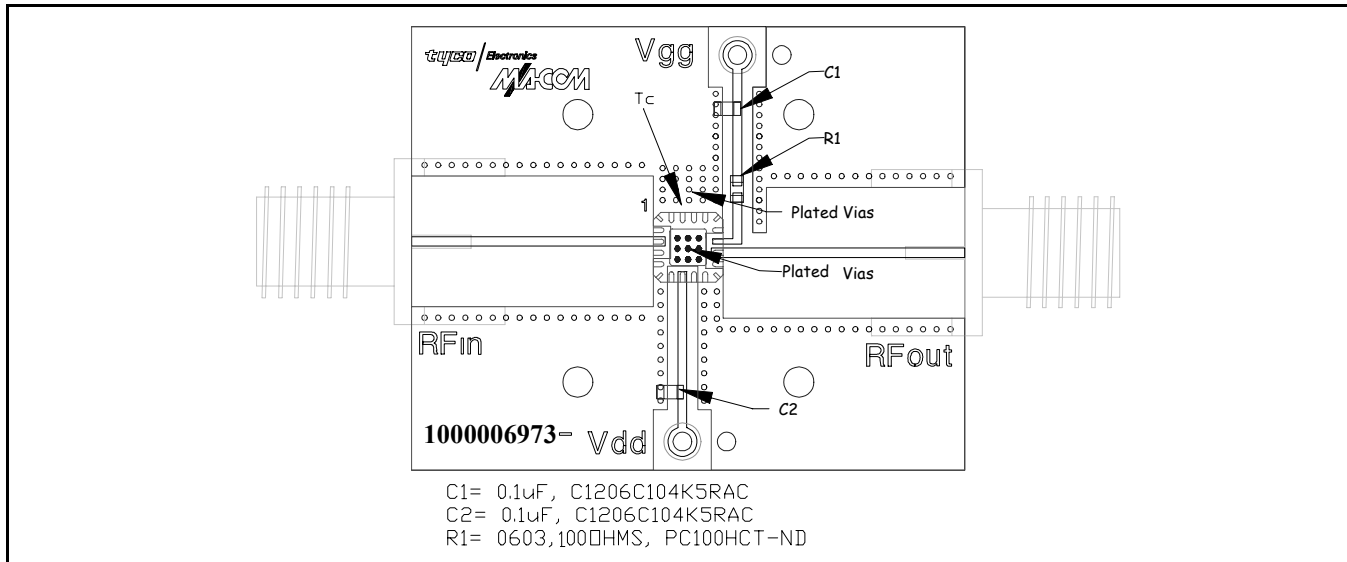

**Notes on board design**

1. Sample board uses RO4350  $\epsilon_r = 3.48$  as dielectric for circuit board. Dielectric thickness is not critical but RFin and RFout transmission lines should be 50 ohms ( $w = 22$  mil for thickness = 10 mil).
2. Solder the exposed paddle on the back of the package to the board. Proper attachment of the exposed paddle is essential for RF and DC ground in addition to providing a low thermal resistance.
3. Case temperature ( $T_c$ ) is measured as shown on the application board drawing on the top circuit board metal as close to the body of the package as possible.
4. The board must provide adequate heat sinking to accommodate the 2.5 W typically dissipated under small signal conditions. Sample board uses vias in the vicinity of the ground pad to provide a suitable heat sink connected to the ground plane of the board as shown above.
5. Placement of C1, C2 and R1 are not critical but use of 1206 for the bypass caps (C1 and C2) is critical.

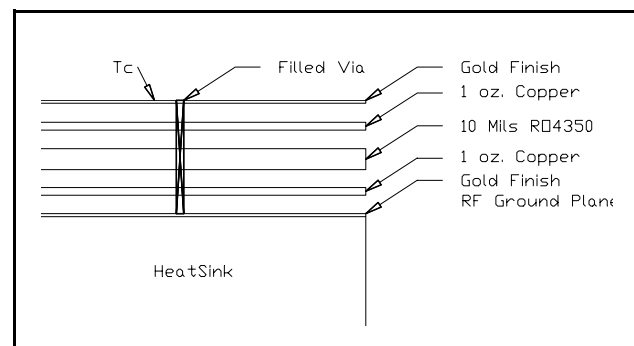

**1 Watt Power Amplifier**  
**4.9 - 6.0 GHz**

**MAAPSM0008**  
**V3**

**Typical Performance Curves**

*Gain Vs. Frequency,  $P_{IN} = +6$  dBm,  $V_{DD} = 7$  V*

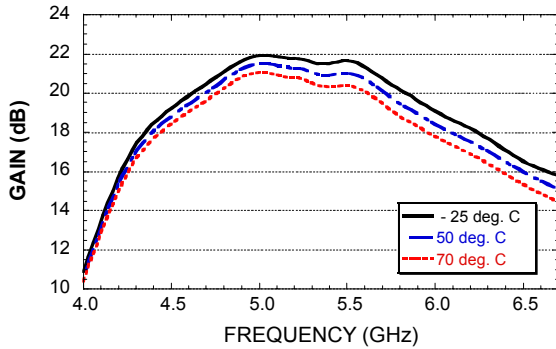

*Gain Vs. Frequency,  $P_{IN} = +6$  dBm,  $V_{DD} = 5$  V*

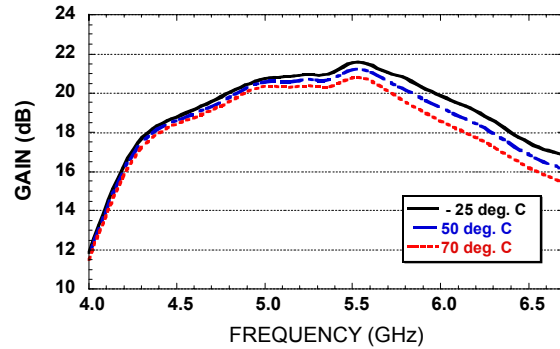

*Output Power Vs. Frequency,  $P_{IN} = +12$  dBm,  $V_{DD} = 7$  V*

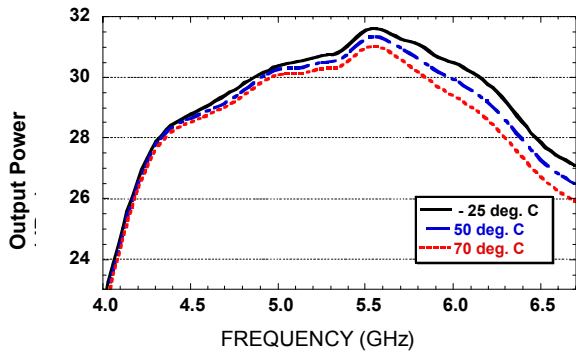

*Output Power Vs. Frequency,  $P_{IN} = +12$  dBm,  $V_{DD} = 5$  V*

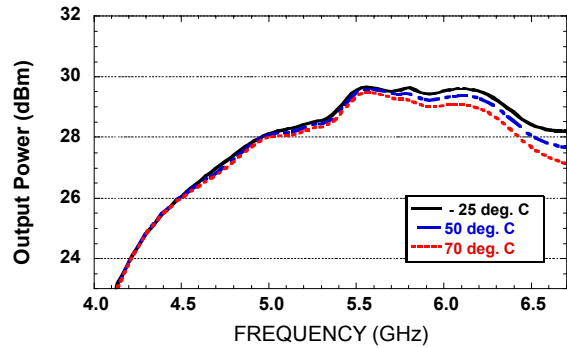

*PAE Vs. Frequency,  $P_{IN} = +12$  dBm,  $V_{DD} = 7$  V*

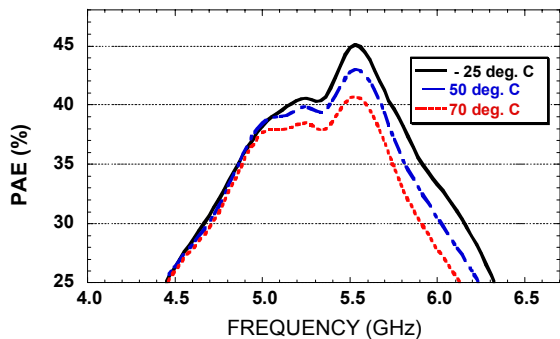

*PAE Vs. Frequency,  $P_{IN} = +12$  dBm,  $V_{DD} = 5$  V*

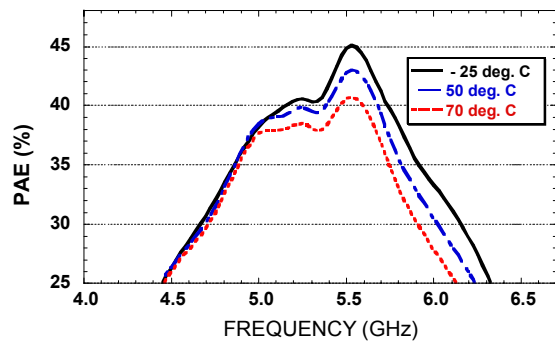

**1 Watt Power Amplifier  
4.9 - 6.0 GHz**

**MAAPSM0008  
V3**

**Typical Performance Curves**

*Input Return Loss Vs. Frequency,  $P_{IN} = +12$  dBm,  $V_{DD} = 7$  V*

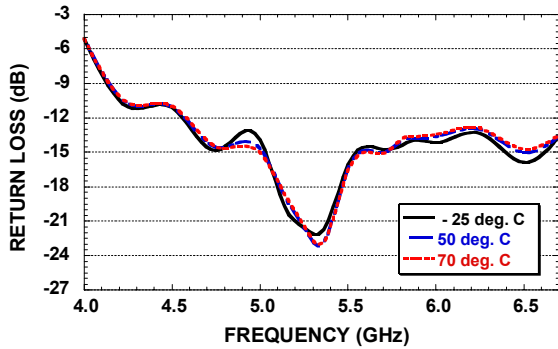

*Input Return Loss Vs. Frequency,  $P_{IN} = +12$  dBm,  $V_{DD} = 5$  V*

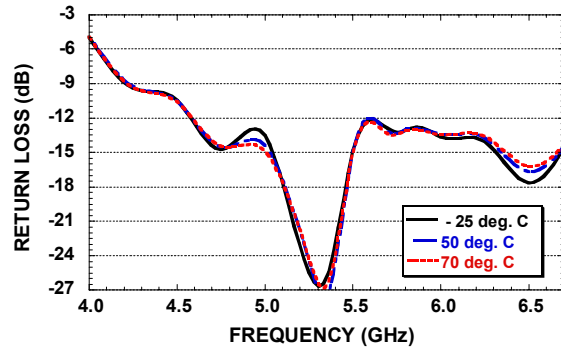

*Stage 2 Dissipated Power vs. Case Temperature  
Freq = 5.25 GHz,  $V_{DD} = 7$  V*

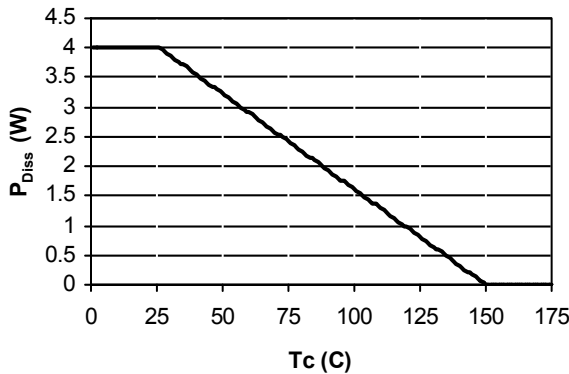

*Output Power & Gain Vs. Input Power,  
Freq = 5.80 GHz,  $V_{DD} = 7$  V*

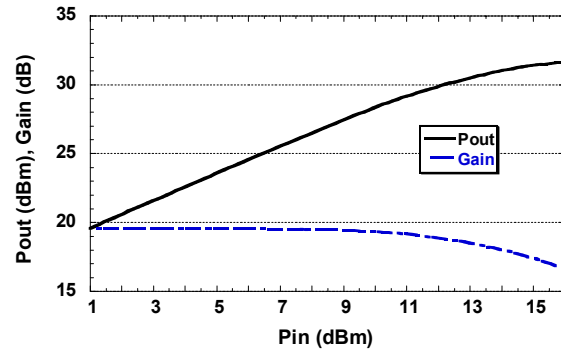

*1-dB Compression Vs. Frequency,  $V_{DD} = 7$  V,  
 $I_{DQ} = 0.360$  A*

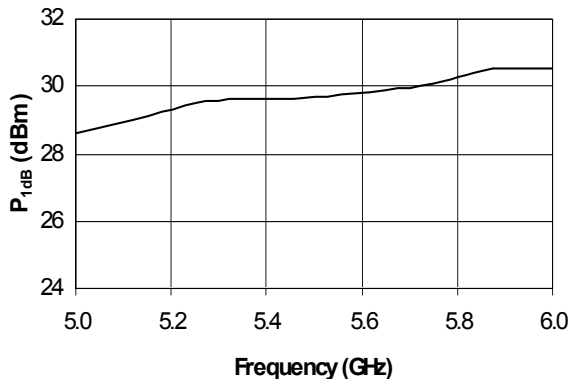

*P1dB, Gain Vs. Quiescent Bias,  $V_{DD} = 7$  V,*

