

**DESCRIPTION**

The LX5115 SCSI terminator is part of Linfinity's UltraMAX family of high-performance, adaptive, non-linear mode SCSI products, which are designed to deliver true UltraSCSI performance in SCSI applications. The low voltage BiCMOS architecture employed in its design offers superior performance to older linear passive and active techniques. Linfinity's UltraMAX architecture employs high-speed adaptive elements for each channel, thereby providing the fastest response possible — typically 35MHz, which is 100 times faster than the older linear regulator/terminator approach used by other manufacturers. Products using this older linear regulator approach have bandwidths which are dominated by the output capacitor and which are limited to 500KHz (see further discussion in the Functional Description section). The UltraMAX architecture also eliminates the output compensation capacitor typical in earlier terminator designs. Each is approved for use with SCSI-1, -2, -3, UltraSCSI and beyond — providing the highest performance alternative available today.

Another key improvement offered by the LX5115 lies in its ability to insure reliable, error-free communications even in systems which do not adhere to recommended SCSI hardware design guidelines, such as the use of improper cable

lengths and impedances. Frequently, this situation is not controlled by the peripheral or host designer and, when problems occur, they are the first to be made aware of the problem. The LX5115 architecture is much more tolerant of marginal system integrations.

Recognizing the needs of portable and configurable peripherals, the LX5115 has a TTL compatible sleep/disable mode. Quiescent current is typically 150µA in this mode, while the output capacitance is also less than 3pF. The obvious advantage of extended battery life for portable systems is inherent in the product's sleep-mode feature. Additionally, the disable function permits factory-floor or production-line configurability, reducing inventory and product-line diversity costs. Field configurability can also be accomplished without physically removing components which, often times results in field returns due to mishandling.

Reduced component counts is also inherent in the LX5115 architecture. Traditional termination techniques require large stabilization and transient protection capacitors of up to 20µF in value and size. The LX5115 architecture does not require these components, allowing all the cost savings associated with inventory, board space, assembly, reliability, and component costs.

**KEY FEATURES**

- ULTRA-FAST RESPONSE FOR FAST-20 SCSI APPLICATIONS
- 35MHz CHANNEL BANDWIDTH
- LESS THAN 3pF OUTPUT CAPACITANCE
- SLEEP-MODE CURRENT OF 150µA
- NO EXTERNAL COMPENSATION CAPACITORS
- IMPLEMENTS 8-BIT OR 16-BIT (WIDE) APPLICATIONS
- COMPATIBLE WITH ACTIVE NEGATION DRIVERS (37mA / CHANNEL)
- COMPATIBLE WITH PASSIVE AND ACTIVE TERMINATIONS
- APPROVED FOR USE WITH SCSI 1, 2, 3 AND ULTRA SCSI
- HOT SWAP COMPATIBLE
- PIN-FOR-PIN COMPATIBLE WITH DS21S07A / 2105

**NOTE:** For current data & package dimensions, visit our web site: <http://www.linfinity.com>.

**PRODUCT HIGHLIGHT**

RECEIVING WAVEFORM - 20MHz

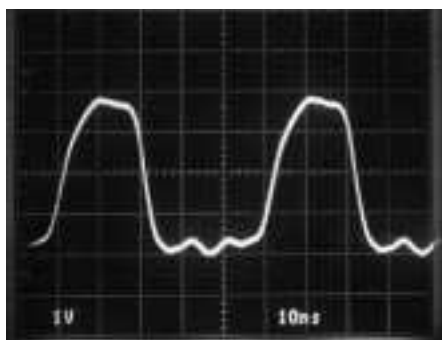

DRIVING WAVEFORM - 20MHz

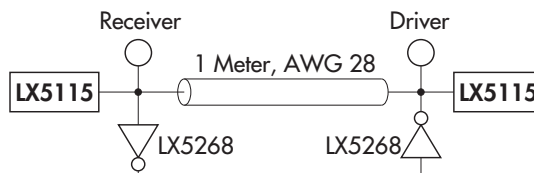
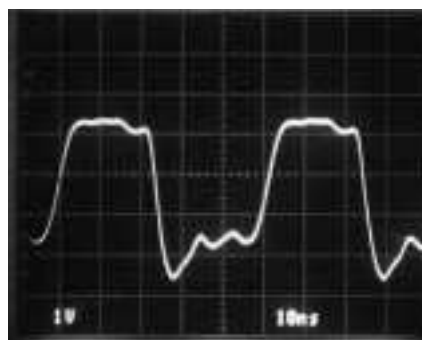

**NOTE:**  
For An In-Depth Discussion On Applying SCSI, Request Linfinity Application Note: "Understanding The Single-Ended SCSI Bus"

**PACKAGE ORDER INFORMATION**

T <sub>J</sub> (°C)	D Plastic SOIC 16-pin	DW Plastic SOWB 16-pin	PWP Plastic TSSOP 20-pin, Power
0 to 70	LX5115CD	LX5115CDW	LX5115CPWP

Note: All surface-mount packages are available in Tape & Reel. Append the letter "T" to part number. (i.e. LX5115CDWT)

**ULTRA 9-CHANNEL SCSI TERMINATOR**

**PRODUCTION DATA SHEET**

**ABSOLUTE MAXIMUM RATINGS (Note 1)**

Continuous Termination Voltage .....	10V
Continuous Output Voltage Range .....	0 to 5.5V
Continuous Disable Voltage Range .....	0 to 5.5V
Operating Junction Temperature .....	0°C to 125°C
Storage Temperature Range .....	-65°C to +150°C
Solder Temperature (Soldering, 10 seconds) .....	300°C

Note 1. Exceeding these ratings could cause damage to the device.

**THERMAL DATA**

**D PACKAGE:**

<b>THERMAL RESISTANCE-JUNCTION TO AMBIENT, <math>\theta_{JA}</math></b>	<b>120°C/W</b>
---	----------------

**DW PACKAGE:**

<b>THERMAL RESISTANCE-JUNCTION TO AMBIENT, <math>\theta_{JA}</math></b>	<b>95°C/W</b>
---	---------------

**PWP PACKAGE:**

<b>THERMAL RESISTANCE-JUNCTION TO AMBIENT, <math>\theta_{JA}</math></b>	<b>139°C/W</b>
---	----------------

Junction Temperature Calculation:  $T_j = T_A + (P_D \times \theta_{JA})$ .  
 The  $\theta_{JA}$  numbers are guidelines for the thermal performance of the device/pc-board system.  
 All of the above assume no ambient airflow.

**PACKAGE PIN OUTS**

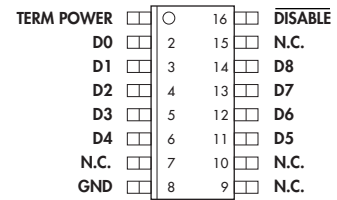

**D PACKAGE**  
(Top View)

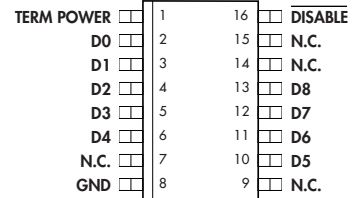

**DW PACKAGE**  
(Top View)

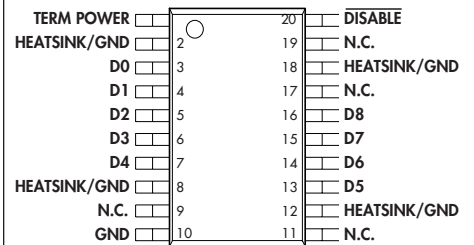

**PWP PACKAGE**  
(Top View)

## ULTRA 9-CHANNEL SCSI TERMINATOR

## PRODUCTION DATA SHEET

## RECOMMENDED OPERATING CONDITIONS (Note 2)

Parameter	Symbol	Recommended Operating Conditions			Units
		Min.	Typ.	Max.	
Termination Voltage	$V_{TERM}$	4.0		5.5	V
High Level Enable Input Voltage	$V_{EH}$	2		$V_{TERM}$	V
Low Level Disable Input Voltage	$V_{EL}$	0		0.8	V
Operating Virtual Junction Temperature Range					
LX5115C		0		125	°C

Note 2. Range over which the device is functional.

## ELECTRICAL CHARACTERISTICS

**Term Power = 4.75V unless otherwise specified.** Unless otherwise specified, these specifications apply at the recommended operating ambient temperature of  $T_A = 25^\circ\text{C}$ . Low duty cycle pulse testing techniques are used which maintains junction and case temperatures equal to the ambient temperature.

Parameter	Symbol	Test Conditions	LX5115			Units
			Min.	Typ.	Max.	
Output High Voltage	$V_{OUT}$		2.65	2.85		V
TermPwr Supply Current	$I_{CC}$	All data lines = open		5.5	9	mA
		All data lines = 0.5V		210	225	mA
		Disable Pin < 0.8V		150		$\mu\text{A}$
Output Current	$I_{OUT}$	$V_{OUT} = 0.5\text{V}$	-21	-23	-24	mA
Disable Input Current	$I_{IN}$	Disable Pin = 4.75V		10		nA
		Disable Pin = 0V		-15		$\mu\text{A}$
Output Leakage Current	$I_{OL}$	Disable Pin = < 0.8V, $V_O = 0.5\text{V}$		20		nA
Capacitance in Disabled Mode	$C_{OUT}$	$V_{OUT} = 0\text{V}$ , frequency = 1MHz		3		pF
Channel Bandwidth	BW			35		MHz
Termination Sink Current, per Channel	$I_{SINK}$	$V_{OUT} = 4\text{V}$		37		mA

ULTRA 9-CHANNEL SCSI TERMINATOR

PRODUCTION DATA SHEET

BLOCK DIAGRAM

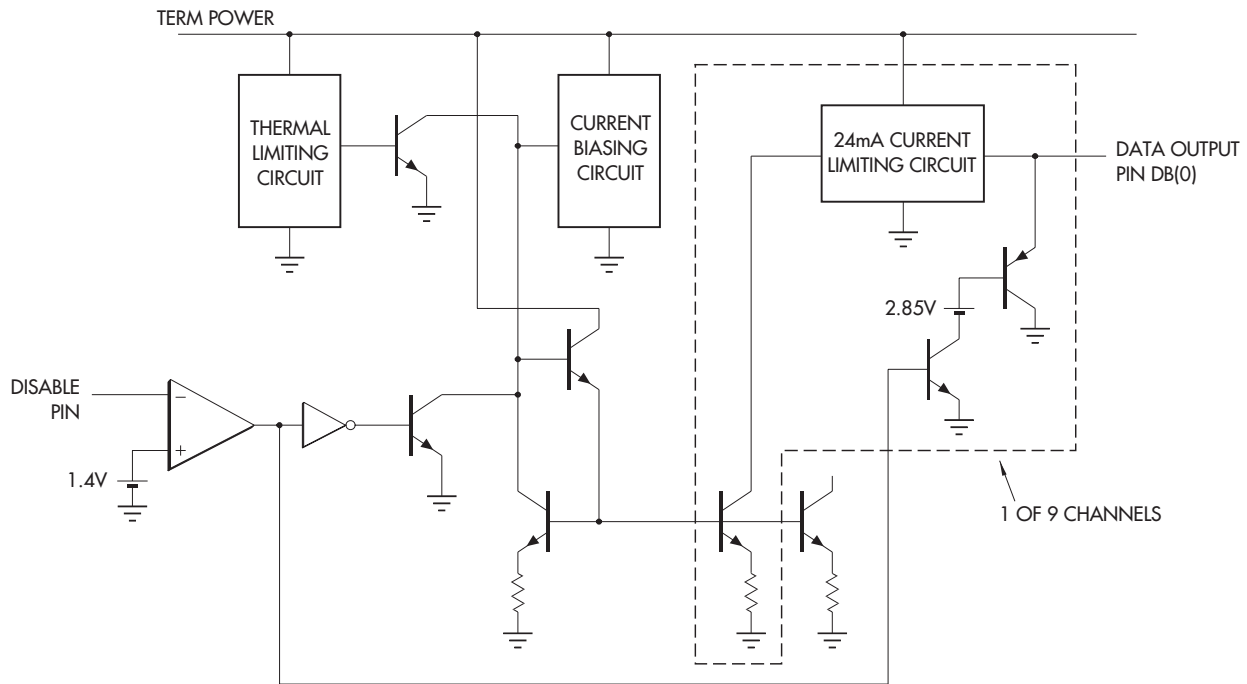

FUNCTIONAL DESCRIPTION

Cable transmission theory suggests to optimize signal speed and quality, the termination should act both as an ideal voltage reference when the line is released (deasserted) and as an ideal current source when the line is active (asserted). Common active terminators, which consist of Linear Regulators in series with resistors (typically 110Ω), are a compromise. As the line voltage increases, the amount of current decreases linearly by the equation  $V = I * R$ . The LX5115, with its unique new architecture applies the maximum amount of current regardless of line voltage until the termination high threshold (2.85V) is reached.

Acting as a near ideal line terminator, the LX5115 closely reproduces the optimum case when the device is enabled. To enable the device the Disable Pin must be pulled Logic High or left open. During this mode of operation, quiescent current is 5.5mA and the device will respond to line demands

by delivering 24mA on assertion and by imposing 2.85V on deassertion. In order to disable the device, the Disable pin must be driven logic **Low**. This mode of operation places the device in a sleep state where a meager 150μA of quiescent current is consumed. Additionally, all outputs are in a Hi-Z (impedance) state. Sleep mode can be used for power conservation or to completely eliminate the terminator from the SCSI chain. In the second case, termination node capacitance is important to consider. The terminator will appear as a parasitic distributed capacitance on the line, which can detract from bus performance. For this reason, the

LX5115 has been optimized to have only 3pF of capacitance per output in the sleep state.

An additional feature of the LX5115 is its compatibility with active negation drivers. The device handles up to 37mA of sink current for drivers which exceed the 2.85V output high.

POWER UP / POWER DOWN FUNCTION TABLE

Disable LX5115	Outputs	Quiescent Current
H	Enabled	5.5mA
L	Hi Z	150μA
Open	Enabled	5.5mA

UltraMAX is a trademark of Linfinity Microelectronics Inc.

PRODUCTION DATA - Information contained in this document is proprietary to Linfinity, and is current as of publication date. This document may not be modified in any way without the express written consent of Linfinity. Product processing does not necessarily include testing of all parameters. Linfinity reserves the right to change the configuration and performance of the product and to discontinue product at any time.

