

4-bit MULTIFUNCTIONAL REAL TIME CLOCK MODULE

# RTC-63421/63421M/63423

- Builtin crystal unit allows adjustment-free efficient operation.
- Alarm interruption of sec. to month and day of week possible.
- Provided with microcomputer compatible bus interface.
- Standard signal output selectable in a range of 10min. to 1024 Hz.
- Either sec. to hour and day of week or sec. to year and day of week is selectable.
- Reference area of time /alarm register is settabl. Provided with RAM bits. (marked on "\*" which is shown resistor table)
- Provided with START/STOP 30 second adjusting function.
- Similar mounting method (RTC-63423) to be used for normal type SMD IC.

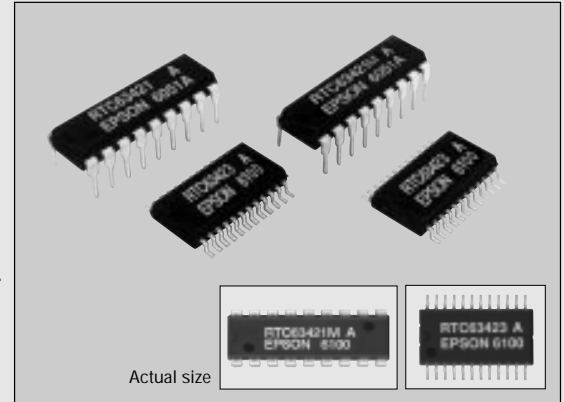

Model	Applicable CPU
RTC-63421	Intel bus system
RTC-63421M	Motorola bus system
RTC-63423	"MOTEL" bus system

### Specifications (characteristics)

#### Absolute Max. rating

Item	Symbol	Condition	Specifications	Unit
Power source voltage	V <sub>DD</sub>	T <sub>a</sub> =25°C	-0.3 to 7.0	V
Input voltage	V <sub>IN</sub>	T <sub>a</sub> =25°C	-0.3 to V <sub>DD</sub> +0.3	
storage temperature	T <sub>STG</sub>	RTC-63421 RTC-63421M	-55 to +85	°C
		RTC-63423	-55 to +125	
Soldering condition	T <sub>SOL</sub>	RTC-63421 RTC-63421M	Under 260°C within 10 sec. (lead part) (package should be less than 150°C)	
		RTC-63423	Twice at under 260°C within 10 sec. or under 230°C within 3 min.	

#### Operating range

Item	Symbol	Condition	Specifications	Unit
Operating voltage	V <sub>DD</sub>	—	4.5 to 5.5	V
Operating temperature	T <sub>OPR</sub>		-40 to +85	°C
Data holding voltage	V <sub>DH</sub>		2.0 to 5.5	V
CS data holding time	t <sub>CDR</sub>	Refer to the data holding timing	2.0 min.	μs
Operation restoring time	t <sub>r</sub>			

#### Frequency characteristics and current consumption characteristics

Item	Symbol	Condition	Specifications	Unit	
Frequency tolerance	Δf/fo	T <sub>a</sub> =25°C V <sub>DD</sub> =5V	63421A/63421MA	+15/-5 (5±10)	ppm
			63421B/63421MB	+55/-45 (5±50)	
			63423 A	+25/-15 (5±20)	
			63423	+55/-45 (5±50)	
Frequency temperature characteristics		-10 to +70°C (25°C reference temperature)	+10/-120		
					-30 to +85°C (25°C reference temperature)
Aging	f <sub>a</sub>	V <sub>DD</sub> =5V, T <sub>a</sub> =25°C, first year	±5 max.	ppm/Y	
Shock resistance	S.R.	Three drops on a hard board from 75 cm or 3000G x 0.3ms x 1/2 sine wave x 3 directions	±10 max.	ppm	
Current consumption	I <sub>DD1</sub> I <sub>DD2</sub>	CS=0V	V <sub>DD</sub> =5V	30max.	μA
			V <sub>DD</sub> =2V	1.8 max.	

Unless otherwise stated, characteristics (specifications) shown in the above table are based on the rated operating temperature and voltage condition.

### Terminal connection

#### RTC-63421/63421M

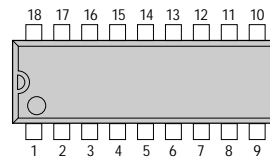

No.	63421/63421M	No.	63423
1	INTERRUPT	1	INTERRUPT
2	CS <sub>1</sub>	2	CS <sub>1</sub>
3	ALE	3	ALARM
4	A <sub>0</sub>	4	ALE
5	A <sub>1</sub>	5	A <sub>0</sub>
6	A <sub>2</sub>	6	30sec.Adj
7	A <sub>3</sub>	7	A <sub>1</sub>
8	RD (E +1)	8	68/80
9	GND	9	A <sub>2</sub>
10	WR (R/W +1)	10	A <sub>3</sub>
11	D <sub>3</sub>	11	RD (E +2)
12	D <sub>2</sub>	12	GND
13	D <sub>1</sub>	13	WR (R/W +2)
14	D <sub>0</sub>	14	D <sub>3</sub>
15	CS <sub>1</sub>	15	D <sub>2</sub>
16	(V <sub>DD</sub> )	16	D <sub>1</sub>
17	(V <sub>DD</sub> )	17	1Hz
18	V <sub>DD</sub>	18	D <sub>0</sub>
		19	CS <sub>1</sub>
		20	STOP/START
		21	NC
		22	(V <sub>DD</sub> )
		23	(V <sub>DD</sub> )
		24	V <sub>DD</sub>

\* 1-63421M      \* 2-Motorola bus system

#### RTC-63423

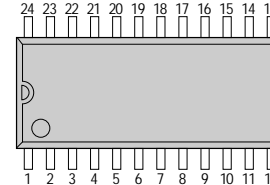

- (V<sub>DD</sub>) is to be same level as V<sub>DD</sub>. Do not connect it to any external terminals.
- NC is not connected internally.

### External dimensions

(Unit: mm)

#### RTC-63421/63421M

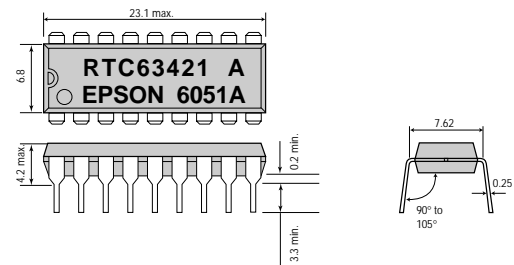

#### RTC-63423

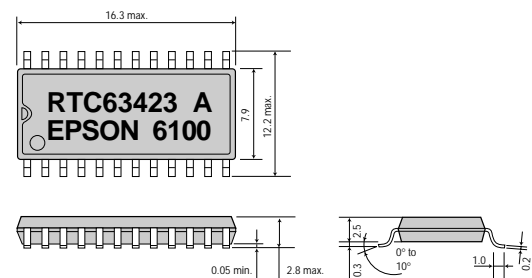

**Data holding timing**

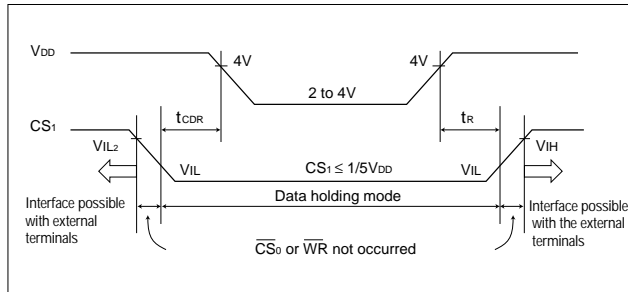

**Register table**

Address	Symbol of register	BANK 0				Real time register name
		D <sub>3</sub>	D <sub>2</sub>	D <sub>1</sub>	D <sub>0</sub>	
0	R-S <sub>1</sub>	r-S <sub>8</sub>	r-S <sub>4</sub>	r-S <sub>2</sub>	r-S <sub>1</sub>	1 - sec. digit register
1	R-S <sub>10</sub>	*	r-S <sub>40</sub>	r-S <sub>20</sub>	r-S <sub>10</sub>	10 - sec. digit register
2	R-MI <sub>1</sub>	r-mi <sub>8</sub>	r-mi <sub>4</sub>	r-mi <sub>2</sub>	r-mi <sub>1</sub>	1 - min. digit register
3	R-MI <sub>10</sub>	*	r-mi <sub>40</sub>	r-mi <sub>20</sub>	r-mi <sub>10</sub>	10 - min. digit register
4	R-H <sub>1</sub>	r-h <sub>8</sub>	r-h <sub>4</sub>	r-h <sub>2</sub>	r-h <sub>1</sub>	1 - hour digit register
5	R-H <sub>10</sub>	*	r-PM/AM	r-h <sub>20</sub>	r-h <sub>10</sub>	10 - hour digit register
6	R-D <sub>1</sub>	r-d <sub>8</sub>	r-d <sub>4</sub>	r-d <sub>2</sub>	r-d <sub>1</sub>	1 - day digit register
7	R-D <sub>10</sub>	*		r-d <sub>20</sub>	r-d <sub>10</sub>	10 - day digit register
8	R-MO <sub>1</sub>	r-mo <sub>8</sub>	r-mo <sub>4</sub>	r-mo <sub>2</sub>	r-mo <sub>1</sub>	1 - month digit register
9	R-MO <sub>10</sub>	*			r-mo <sub>10</sub>	10 - month digit register
A	R-Y <sub>1</sub>	r-y <sub>8</sub>	r-y <sub>4</sub>	r-y <sub>2</sub>	r-y <sub>1</sub>	1 - year digit register
B	R-Y <sub>10</sub>	r-y <sub>80</sub>	r-y <sub>40</sub>	r-y <sub>20</sub>	r-y <sub>10</sub>	10 - year digit register
C	R-W	*	r-w <sub>4</sub>	r-w <sub>2</sub>	r-w <sub>1</sub>	Week register
D	C <sub>D</sub>	IT/PLS <sub>2</sub>	IT/PLS <sub>1</sub>	MASK <sub>2</sub>	MASK <sub>1</sub>	Control register D
E	C <sub>E</sub>	IRQ · FLAG <sub>0</sub>	RESET	IRQ · FLAG <sub>2</sub>	IRQ · FLAG <sub>1</sub>	Control register E
F	C <sub>F</sub>	BANK <sub>1</sub> BANK <sub>0</sub>	STOP	30 sec. ADJ	READ FLAG	Control register F

Symbol of register	BANK 1				Alarm register name
	D <sub>3</sub>	D <sub>2</sub>	D <sub>1</sub>	D <sub>0</sub>	
A-S <sub>1</sub>	a-S <sub>8</sub>	a-S <sub>4</sub>	a-S <sub>2</sub>	a-S <sub>1</sub>	1 - sec. digit register
A-S <sub>10</sub>	*	a-S <sub>40</sub>	a-S <sub>20</sub>	a-S <sub>10</sub>	10 - sec. digit register
A-MI <sub>1</sub>	a-mi <sub>8</sub>	a-mi <sub>4</sub>	a-mi <sub>2</sub>	a-mi <sub>1</sub>	1 - min. digit register
A-MI <sub>10</sub>	*	a-mi <sub>40</sub>	a-mi <sub>20</sub>	a-mi <sub>10</sub>	10 - min. digit register
A-H <sub>1</sub>	a-h <sub>8</sub>	a-h <sub>4</sub>	a-h <sub>2</sub>	a-h <sub>1</sub>	1 - hour digit register
A-H <sub>10</sub>	*	a-PM/AM	a-h <sub>20</sub>	a-h <sub>10</sub>	10 - hour digit register
A-D <sub>1</sub>	a-d <sub>8</sub>	a-d <sub>4</sub>	a-d <sub>2</sub>	a-d <sub>1</sub>	1 - day digit register
A-D <sub>10</sub>	*		a-d <sub>20</sub>	a-d <sub>10</sub>	10 - day digit register
A-MO <sub>1</sub>	a-mo <sub>8</sub>	a-mo <sub>4</sub>	a-mo <sub>2</sub>	a-mo <sub>1</sub>	1 - month digit register
A-MO <sub>10</sub>	*			a-mo <sub>10</sub>	10 - month digit register
A-W	*	r-w <sub>4</sub>	a-w <sub>2</sub>	a-w <sub>1</sub>	Week register
A-EMB	ae <sub>8</sub>	ae <sub>4</sub>	ae <sub>2</sub>	ae <sub>1</sub>	Area define register
C <sub>c</sub>	*		TEST <sub>2</sub>	TEST <sub>1</sub>	Test register
C <sub>D</sub>	*	CY <sub>2</sub>	CY <sub>1</sub>	CY <sub>0</sub>	Control register D
C <sub>E</sub>	HD/SFT	24/12	CAL	D · P	Control register E
C <sub>F</sub>	Same as BANK 0				Control register F

**Switching characteristics**

Motorola bus system (V<sub>DD</sub> = 5V ± 0.5V, T<sub>a</sub> = 0 to + 70°C)

Item	Symbol	Min.	Max.	Unit
R/W, address setup time	t <sub>RWE</sub>	100		ns
E "H" pulse width	t <sub>EHW</sub>	220		
R/W, address hold time	t <sub>ERW</sub>	20		
E "L" pulse width	t <sub>ELW</sub>	220		
E cycle time	t <sub>EC</sub>	500		
DATA setup time	t <sub>DS</sub>	180		
DATA hold time	t <sub>DH</sub>	20		
E to data (CL=150pF)	t <sub>RD</sub>	—	120	
Data hold	t <sub>ED</sub>	10	—	

Switching characteristics on the Intel bus system are the same as those for the RTC-6242 series.

**Write mode**

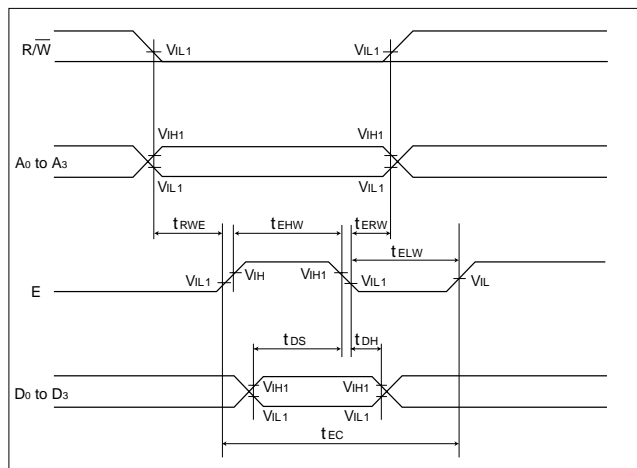

**Read mode**

